

# Small switching (30V, 0.1A)

## 2SK3019

### ●Applications

Interfacing, switching (30V, 100mA)

### ●Features

- 1) Low on-resistance.
- 2) Fast switching speed.
- 3) Low voltage drive (2.5V) makes this device ideal for portable equipment.
- 4) Easily designed drive circuits.
- 5) Easy to parallel.

### ●Structure

Silicon N-channel  
MOSFET

### ●External dimensions (Units : mm)

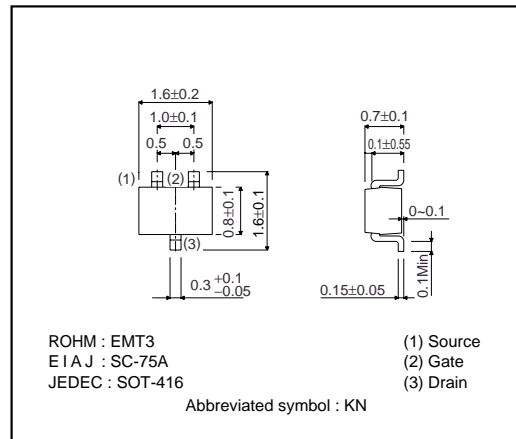

### ●Absolute maximum ratings (Ta=25°C)

Parameter	Symbol	Limits	Unit	
Drain-source voltage	$V_{DS}$	30	V	
Gate-source voltage	$V_{GS}$	$\pm 20$	V	
Drain current	Continuous	$I_D$	100	mA
	Pulsed	$I_{DP}^{*1}$	200	mA
Reverse drain current	Continuous	$I_{DR}$	100	mA
	Pulsed	$I_{DRP}^{*1}$	200	mA
Total power dissipation (Tc=25°C)	$P_D^{*2}$	150	mW	
Channel temperature	Tch	150	°C	
Storage temperature	Tstg	-55~+150	°C	

\*1  $P_w \leq 10\mu s$ , Duty cycle  $\leq 50\%$

\*2 With each pin mounted on the recommended lands.

### ●Equivalent circuit

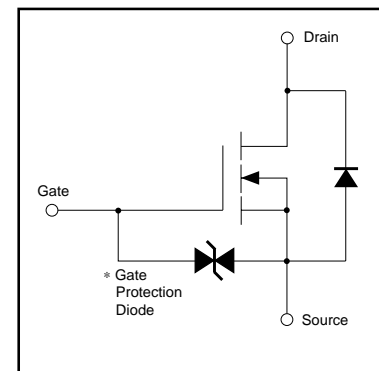

\*A protection diode is included between the gate and the source terminals to protect the diode against static electricity when the product is in use. Use a protection circuit when the fixed voltages are exceeded.

Transistor

●Electrical characteristics (Ta=25°C)

Parameter	Symbol	Min.	Typ.	Max.	Unit	Conditions
Gate-source leakage	I <sub>gss</sub>	–	–	±1	μA	V <sub>GS</sub> =±20V, V <sub>DS</sub> =0V
Drain-source breakdown voltage	V <sub>(BR)DSS</sub>	30	–	–	V	I <sub>D</sub> =10μA, V <sub>GS</sub> =0V
Zero gate voltage drain current	I <sub>DSS</sub>	–	–	1.0	μA	V <sub>DS</sub> =30V, V <sub>GS</sub> =0V
Gate threshold voltage	V <sub>GS(th)</sub>	0.8	–	1.5	V	V <sub>DS</sub> =3V, I <sub>D</sub> =100μA
Static drain-source on-state resistance	R <sub>DS(on)</sub>	–	5	8	Ω	I <sub>D</sub> =10mA, V <sub>GS</sub> =4V
	R <sub>DS(on)</sub>	–	7	13	Ω	I <sub>D</sub> =1mA, V <sub>GS</sub> =2.5V
Forward transfer admittance	Y <sub>fs</sub>	20	–	–	ms	I <sub>D</sub> =10mA, V <sub>DS</sub> =3V
Input capacitance	C <sub>iss</sub>	–	13	–	pF	V <sub>DS</sub> =5V
Output capacitance	C <sub>oss</sub>	–	9	–	pF	V <sub>GS</sub> =0V
Reverse transfer capacitance	C <sub>rss</sub>	–	4	–	pF	f=1MHz
Turn-on delay time	t <sub>d(on)</sub>	–	15	–	ns	I <sub>D</sub> =10mA, V <sub>DD</sub> ≐5V
Rise time	t <sub>r</sub>	–	35	–	ns	V <sub>GS</sub> =5V
Turn-off delay time	t <sub>d(off)</sub>	–	80	–	ns	R <sub>L</sub> =500Ω
Fall time	t <sub>f</sub>	–	80	–	ns	R <sub>GS</sub> =10Ω

●Packaging specifications

Type	Package	Taping
	Code	TL
	Basic ordering unit (pieces)	3000
2SK3019		○

●Electrical characteristic curves

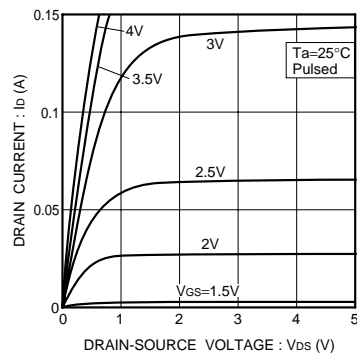

Fig.1 Typical output characteristics

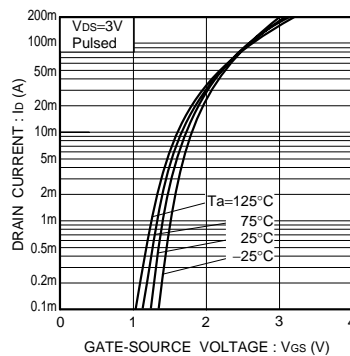

Fig.2 Typical transfer characteristics

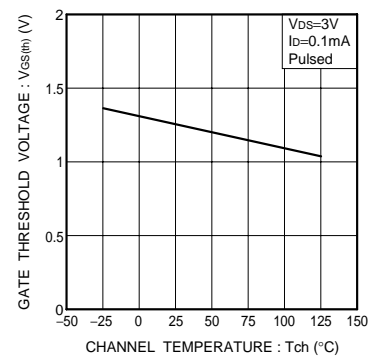

Fig.3 Gate threshold voltage vs. channel temperature

Transistor

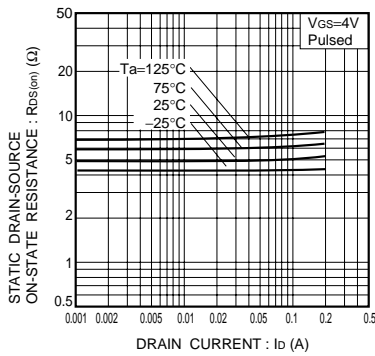

Fig.4 Static drain-source on-state resistance vs. drain current (I)

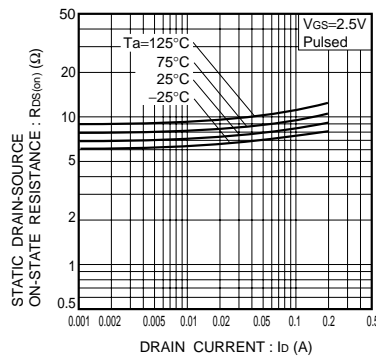

Fig.5 Static drain-source on-state resistance vs. drain current (II)

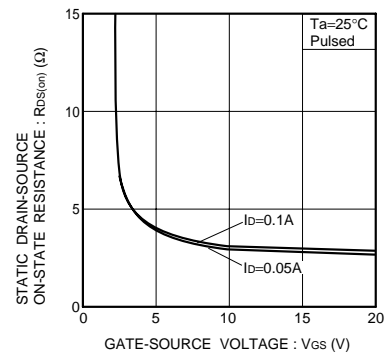

Fig.6 Static drain-source on-state resistance vs. gate-source voltage

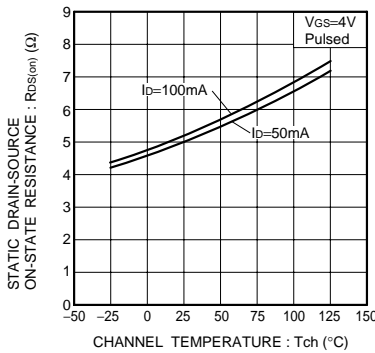

Fig.7 Static drain-source on-state resistance vs. channel temperature

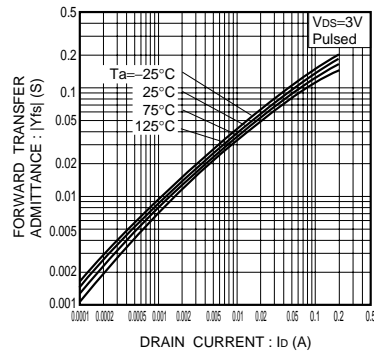

Fig.8 Forward transfer admittance vs. drain current

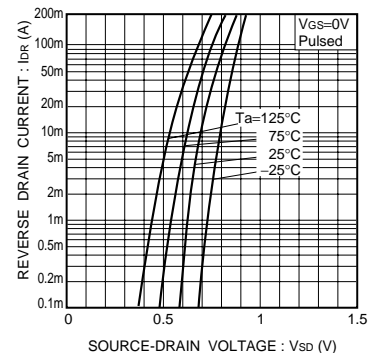

Fig.9 Reverse drain current vs. source-drain voltage (I)

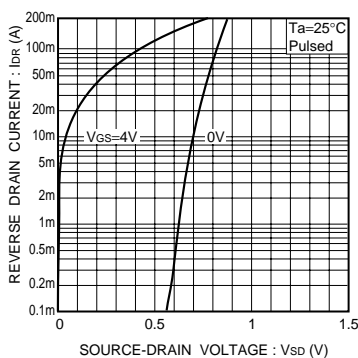

Fig.10 Reverse drain current vs. source-drain voltage (II)

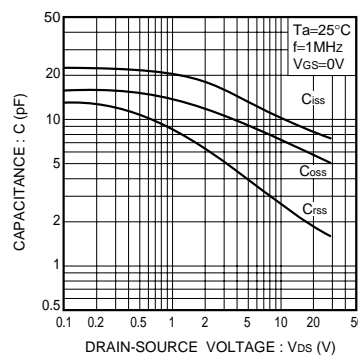

Fig.11 Typical capacitance vs. drain-source voltage

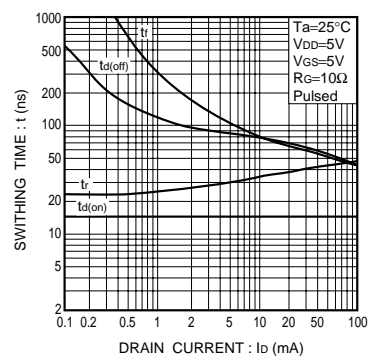

Fig.12 Switching characteristics (See Figures 13 and 14 for the measurement circuit and resultant waveforms)

## Transistor

### ● Switching characteristics measurement circuit

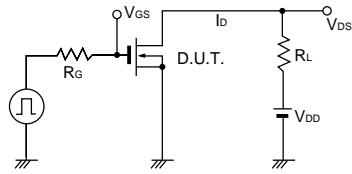

Fig.13 Switching time measurement circuit

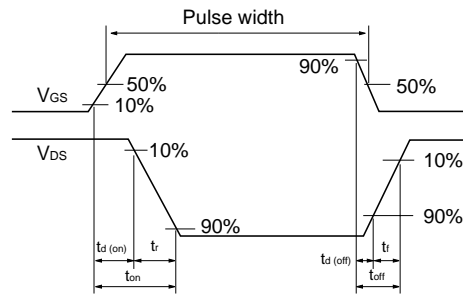

Fig.14 Switching time waveforms