

Austin MiniLynx™: SIP Non-Isolated DC-DC Power Modules

2.4Vdc – 5.5Vdc input; 0.75Vdc to 3.63Vdc output; 3A Output Current

RoHS Compliant



Applications

- Distributed power architectures
- Intermediate bus voltage applications
- Telecommunications equipment
- Servers and storage applications
- Networking equipment
- Enterprise Networks
- Latest generation IC's (DSP, FPGA, ASIC) and Microprocessor powered applications

Description

Austin MiniLynx™ SIP (single-in-line) power modules are non-isolated DC-DC converters that can deliver up to 3A of output current with full load efficiency of 94.0% at 3.3V output. These modules provide a precisely regulated output voltage programmable via an external resistor from 0.75Vdc to 3.63Vdc over a wide range of input voltage ($V_{IN} = 2.4 - 5.5Vdc$). Their open-frame construction and small footprint enable designers to develop cost- and space-efficient solutions. In addition to sequencing, standard features include remote On/Off, programmable output voltage and over current protection.

Features

- Compliant to RoHS Directive 2011/65/EU and amended Directive (EU)
- Compliant to REACH Directive (EC) No 1907/2006
- Delivers up to 3A output current
- High efficiency – 94% at 3.3V full load ($V_{IN} = 5.0V$)
- Small size and low profile:
22.9 mm x 10.2 mm x 6.63 mm
(0.90 in. x 0.40 in. x 0.261 in.)
- Low output ripple and noise
- High Reliability:
Calculated MTBF = 11.9M hours at 25°C Full-load
- Constant switching frequency (300 kHz)
- Output voltage programmable from 0.75 Vdc to 3.63Vdc via external resistor
- Line Regulation: 0.4% (typical)
- Load Regulation: 0.4% (typical)
- Temperature Regulation: 0.4 % (typical)
- Remote On/Off
- Output overcurrent protection (non-latching)
- Wide operating temperature range (-40°C to 85°C)
- *ANSI/UL* 62368-1 and CAN/CSA† C22.2 No. 62368-1 Recognized, DIN VDE‡ 0868-1/A11:2017 (EN62368-1:2014/A11:2017)*
- ISO** 9001 and ISO 14001 certified manufacturing facilities

* UL is a registered trademark of Underwriters Laboratories, Inc.

† CSA is a registered trademark of Canadian Standards Association.

‡ VDE is a trademark of Verband Deutscher Elektrotechniker e.V.

** ISO is a registered trademark of the International Organization of Standards

Austin MiniLynx™: SIP Non-Isolated DC-DC Power Modules

2.4Vdc – 5.5Vdc input; 0.75Vdc to 3.63Vdc output; 3A Output Current

Absolute Maximum Ratings

Stresses in excess of the absolute maximum ratings can cause permanent damage to the device. These are absolute stress ratings only, functional operation of the device is not implied at these or any other conditions in excess of those given in the operations sections of the data sheet. Exposure to absolute maximum ratings for extended periods can adversely affect the device reliability.

Parameter	Device	Symbol	Min	Max	Unit
Input Voltage Continuous	All	V_{IN}	-0.3	5.8	Vdc
Operating Ambient Temperature (see Thermal Considerations section)	All	T_A	-40	85	°C
Storage Temperature	All	T_{stg}	-55	125	°C

Electrical Specifications

Unless otherwise indicated, specifications apply over all operating input voltage, resistive load, and temperature conditions.

Parameter	Device	Symbol	Min	Typ	Max	Unit
Operating Input Voltage	$V_{O,set} \leq V_{IN} - 0.5V$	V_{IN}	2.4	—	5.5	Vdc
Maximum Input Current ($V_{IN} = V_{IN,min}$ to $V_{IN,max}$, $I_O = I_{O,max}$, $V_{O,set} = 3.3Vdc$)	All	$I_{IN,max}$			3.0	Adc
Input No Load Current ($V_{IN} = 5.0Vdc$, $I_O = 0$, module enabled)	$V_{O,set} = 0.75Vdc$	$I_{IN,No\ load}$		10		mA
	$V_{O,set} = 3.3Vdc$	$I_{IN,No\ load}$		17		mA
Input Stand-by Current ($V_{IN} = 5.0Vdc$, module disabled)	All	$I_{IN,stand-by}$		0.6		mA
Inrush Transient	All	I^2t			0.04	A ² s
Input Reflected Ripple Current, peak-to-peak (5Hz to 20MHz, 1μH source impedance; $V_{IN,min}$ to $V_{IN,max}$, $I_O = I_{O,max}$; See Test configuration section)	All			35		mAp-p
Input Ripple Rejection (120Hz)	All			30		dB

CAUTION: This power module is not internally fused. An input line fuse must always be used.

This power module can be used in a wide variety of applications, ranging from simple standalone operation to being part of a complex power architecture. To preserve maximum flexibility, internal fusing is not included, however, to achieve maximum safety and system protection, always use an input line fuse. The safety agencies require a fast-acting fuse with a maximum rating of 6 A (see Safety Considerations section). Based on the information provided in this data sheet on inrush energy and maximum dc input current, the same type of fuse with a lower rating can be used. Refer to the fuse manufacturer's data sheet for further information.

Austin MiniLynx™: SIP Non-Isolated DC-DC Power Modules

2.4Vdc – 5.5Vdc input; 0.75Vdc to 3.63Vdc output; 3A Output Current

Electrical Specifications (continued)

Parameter	Device	Symbol	Min	Typ	Max	Unit
Output Voltage Set-point ($V_{IN}=V_{IN, min}$, $I_o=I_{o, max}$, $T_A=25^\circ C$)	All	$V_{O, set}$	-2.0	$V_{O, set}$	+2.0	% $V_{O, set}$
Output Voltage (Over all operating input voltage, resistive load, and temperature conditions until end of life)	All	$V_{O, set}$	-3%	—	+3%	% $V_{O, set}$
Adjustment Range Selected by an external resistor	All	V_o	0.7525		3.63	Vdc
Output Regulation Line ($V_{IN}=V_{IN, min}$ to $V_{IN, max}$) Load ($I_o=I_{o, min}$ to $I_{o, max}$) Temperature ($T_{ref}=T_{A, min}$ to $T_{A, max}$)	All All All		— — —	0.4 0.4 0.4	— — —	% $V_{O, set}$ % $V_{O, set}$ % $V_{O, set}$
Output Ripple and Noise on nominal output ($V_{IN}=V_{IN, nom}$ and $I_o=I_{o, min}$ to $I_{o, max}$ Cout = 1µF ceramic//10µFtantalum capacitors)						
RMS (5Hz to 20MHz bandwidth)	All		—	10	15	mV _{rms}
Peak-to-Peak (5Hz to 20MHz bandwidth)	All		—	25	50	mV _{pk-pk}
External Capacitance ESR ≥ 1 mΩ ESR ≥ 10 mΩ	All All	$C_{O, max}$ $C_{O, max}$	— —	— —	1000 3000	µF µF
Output Current	All	I_o	0		3	Adc
Output Current Limit Inception (Hiccup Mode) ($V_o=90\%$ of $V_{O, set}$)	All	$I_{o, lim}$	—	220	—	% I_o
Output Short-Circuit Current ($V_o \leq 250mV$) (Hiccup Mode)	All	$I_{o, s/c}$	—	2	—	Adc
Efficiency $V_{IN}=V_{IN, nom}$, $T_A=25^\circ C$ $I_o=I_{o, max}$, $V_o=V_{O, set}$		η η η η η η η		81.5 87.0 89.0 90.0 93.0 94.0		% % % % % %
Switching Frequency	All	f_{sw}	—	300	—	kHz
Dynamic Load Response ($dI_o/dt=2.5A/\mu s$; $V_{IN}=V_{IN, nom}$; $T_A=25^\circ C$) Load Change from $I_o=50\%$ to 100% of $I_{o, max}$; 1µF ceramic// 10 µF tantalum Peak Deviation Settling Time ($V_o < 10\%$ peak deviation)	All	V_{pk}	—	250	—	mV
($dI_o/dt=2.5A/\mu s$; $V_{IN}=V_{IN, nom}$; $T_A=25^\circ C$) Load Change from $I_o=100\%$ to 50% of $I_{o, max}$; 1µF ceramic// 10 µF tantalum Peak Deviation Settling Time ($V_o < 10\%$ peak deviation)	All All	t_s V_{pk}	— —	50 250	— —	µs mV
	All	t_s	—	50	—	µs

Austin MiniLynx™: SIP Non-Isolated DC-DC Power Modules

2.4Vdc – 5.5Vdc input; 0.75Vdc to 3.63Vdc output; 3A Output Current

Electrical Specifications (continued)

Parameter	Device	Symbol	Min	Typ	Max	Unit
Dynamic Load Response ($dI_o/dt=2.5A/\mu s$; $V_{IN} = V_{IN, nom}$; $T_A=25^\circ C$) Load Change from $I_o= 50\%$ to 100% of $I_{o,max}$; $C_o = 2 \times 150 \mu F$ polymer capacitors Peak Deviation	All	V_{pk}	—	60	—	mV
Settling Time ($V_o < 10\%$ peak deviation)	All	t_s	—	100	—	μs
($dI_o/dt=2.5A/\mu s$; $V_{IN} = V_{IN, nom}$; $T_A=25^\circ C$) Load Change from $I_o= 100\%$ to 50% of $I_{o,max}$; $C_o = 2 \times 150 \mu F$ polymer capacitors Peak Deviation	All	V_{pk}	—	60	—	mV
Settling Time ($V_o < 10\%$ peak deviation)	All	t_s	—	100	—	μs

General Specifications

Parameter	Min	Typ	Max	Unit
Calculated MTBF ($I_o=I_{o,max}$, $T_A=25^\circ C$)		11,965,153		Hours
Weight	—	2.8 (0.1)	—	g (oz.)

Austin MiniLynx™: SIP Non-Isolated DC-DC Power Modules

2.4Vdc – 5.5Vdc input; 0.75Vdc to 3.63Vdc output; 3A Output Current

Feature Specifications

Unless otherwise indicated, specifications apply over all operating input voltage, resistive load, and temperature conditions. See Feature Descriptions for additional information.

Parameter	Device	Symbol	Min	Typ	Max	Unit
On/Off Signal interface						
Device code with Suffix "4" – Positive logic (On/Off is open collector/drain logic input; Signal referenced to GND - See feature description section)						
Input High Voltage (Module ON)	All	V _{IH}	—	—	V _{IN,max}	V
Input High Current	All	I _{IH}	—	—	10	μA
Input Low Voltage (Module OFF)	All	V _{IL}	-0.2	—	0.3	V
Input Low Current	All	I _{IL}	—	0.2	1	mA
Device Code with no suffix – Negative Logic (On/OFF pin is open collector/drain logic input with external pull-up resistor; signal referenced to GND)						
Input High Voltage (Module OFF)	All	V _{IH}	1.5	—	V _{IN,max}	Vdc
Input High Current	All	I _{IH}	—	0.2	1	mA
Input Low Voltage (Module ON)	All	V _{IL}	-0.2	—	0.3	Vdc
Input low Current	All	I _{IL}	—	—	10	μA
Turn-On Delay and Rise Times (I _o =I _{o,max} , V _{IN} = V _{IN,nom} , T _A = 25 °C,)						
Case 1: On/Off input is set to Logic Low (Module ON) and then input power is applied (delay from instant at which V _{IN} =V _{IN,min} until Vo=10% of Vo,set)	All	T _{delay}	—	4	—	msec
Case 2: Input power is applied for at least one second and then the On/Off input is set to logic Low (delay from instant at which Von/Off=0.3V until Vo=10% of Vo, set)	All	T _{delay}	—	4	—	msec
Output voltage Rise time (time for Vo to rise from 10% of Vo,set to 90% of Vo, set)	All	T _{rise}	—	4	—	msec
Output voltage overshoot – Startup I _o = I _{o,max} ; V _{IN} = 2.4 to 5.5Vdc, T _A = 25 °C				—	1	% V _{o,set}
Remote Sense Range			—	—	0.5	
Overtemperature Protection (See Thermal Consideration section)	All	T _{ref}	—	140	—	°C
Input Undervoltage Lockout						
Turn-on Threshold	All			2.2		V
Turn-off Threshold	All			2.0		V

Austin MiniLynx™: SIP Non-Isolated DC-DC Power Modules

2.4Vdc – 5.5Vdc input; 0.75Vdc to 3.63Vdc output; 3A Output Current

Characteristic Curves

The following figures provide typical characteristics for the Austin MiniLynx™ SIP modules at 25°C.

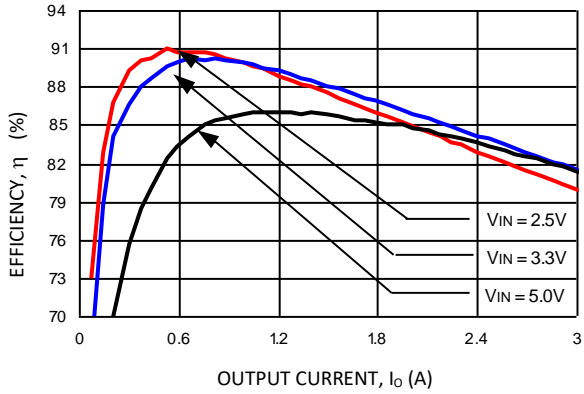

Figure 1. Converter Efficiency versus Output Current (Vout = 0.75Vdc).

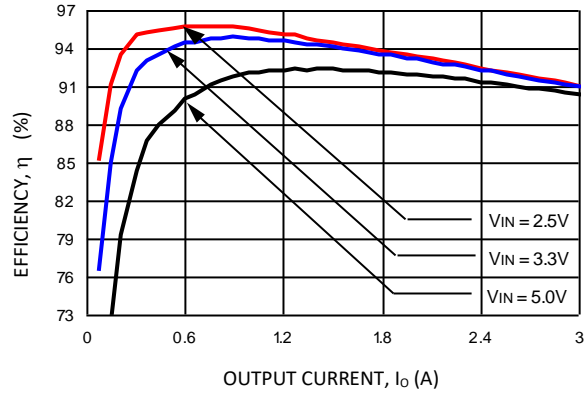

Figure 4. Converter Efficiency versus Output Current (Vout = 1.8Vdc).

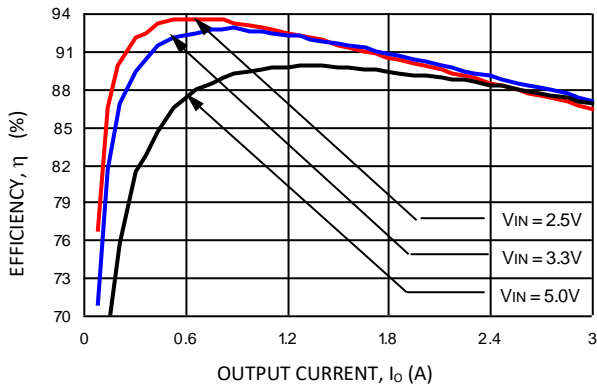

Figure 2. Converter Efficiency versus Output Current (Vout = 1.2Vdc).

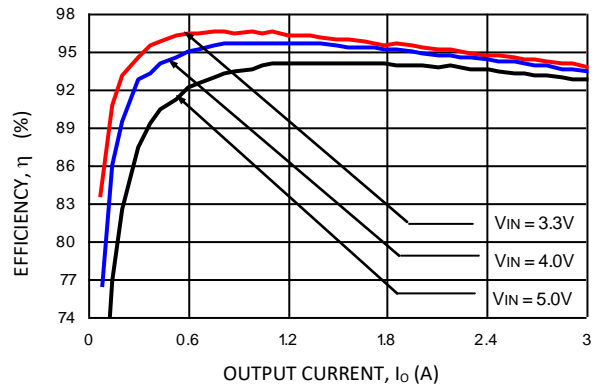

Figure 5. Converter Efficiency versus Output Current (Vout = 2.5Vdc).

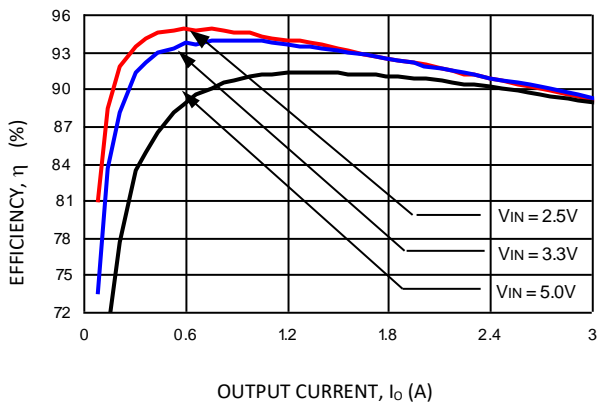

Figure 3. Converter Efficiency versus Output Current (Vout = 1.5Vdc).

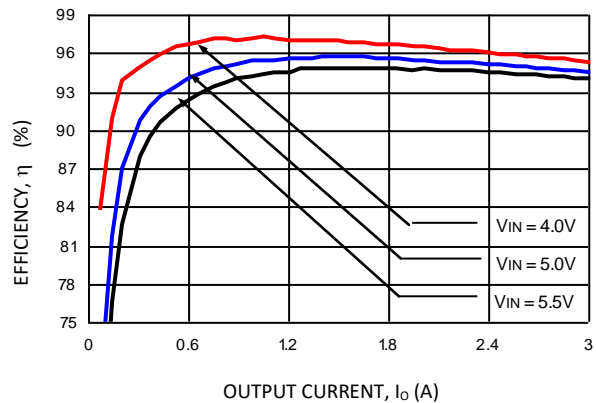

Figure 6. Converter Efficiency versus Output Current (Vout = 3.3Vdc).

Austin MiniLynx™: SIP Non-Isolated DC-DC Power Modules

2.4Vdc – 5.5Vdc input; 0.75Vdc to 3.63Vdc output; 3A Output Current

Characteristic Curves (continued)

The following figures provide typical characteristics for the Austin MiniLynx™ SIP modules at 25°C.

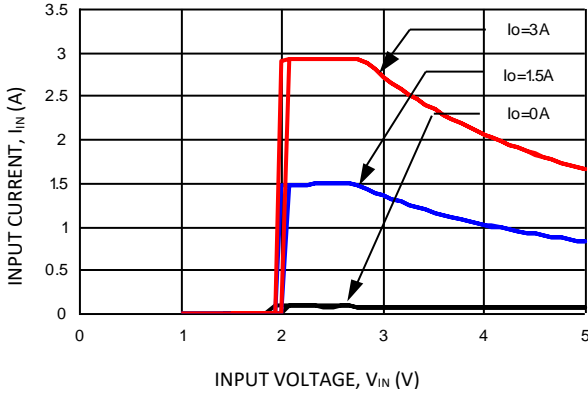

Figure 7. Input voltage vs. Input Current
($V_{out} = 2.5Vdc$).

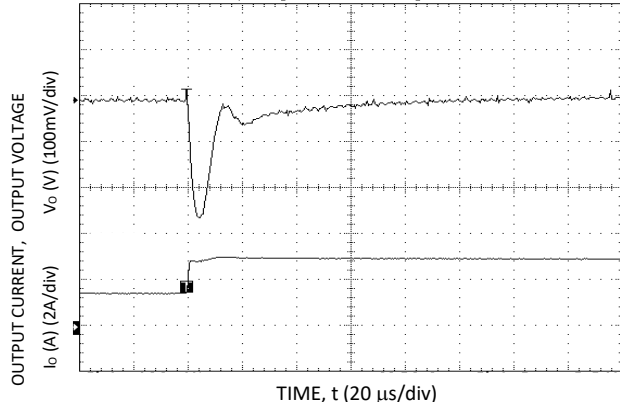

Figure 10. Transient Response to Dynamic Load Change from 50% to 100% of full load ($V_o = 3.3Vdc$).

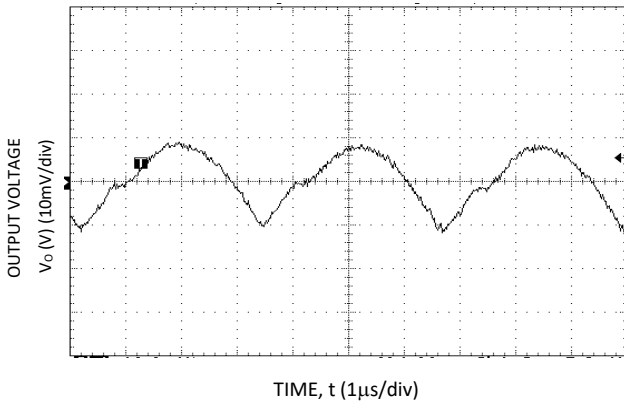

Figure 8. Typical Output Ripple and Noise
($V_{IN} = 5.0Vdc$, $V_o = 0.75Vdc$, $I_o = 3A$).

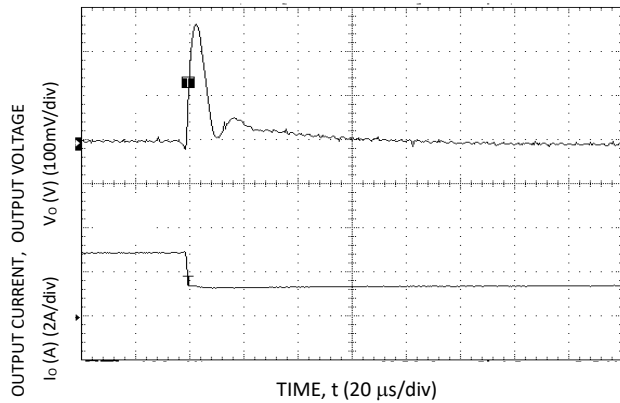

Figure 11. Transient Response to Dynamic Load Change from 100% to 50% of full load ($V_o = 3.3Vdc$).

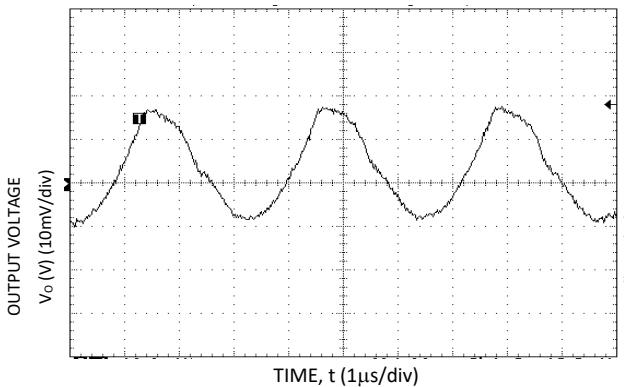

Figure 9. Typical Output Ripple and Noise
($V_{IN} = 5.0Vdc$, $V_o = 3.3Vdc$, $I_o = 3A$).

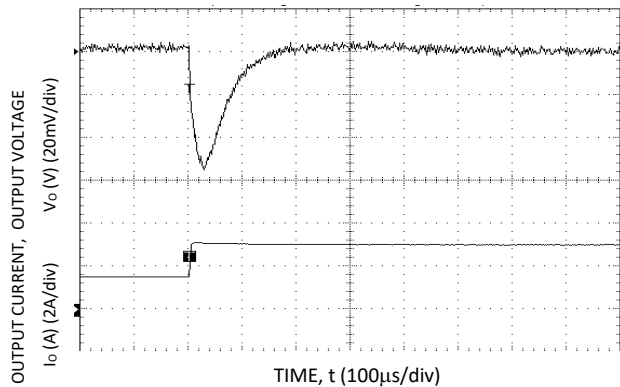

Figure 12. Transient Response to Dynamic Load Change from 50% to 100% of full load ($V_o = 3.3Vdc$, $C_{ext} = 2 \times 150 \mu F$ Polymer Capacitors).

Austin MiniLynx™: SIP Non-Isolated DC-DC Power Modules

2.4Vdc – 5.5Vdc input; 0.75Vdc to 3.63Vdc output; 3A Output Current

Characteristic Curves (continued)

The following figures provide typical characteristics for the Austin MiniLynx™ SIP modules at 25°C.

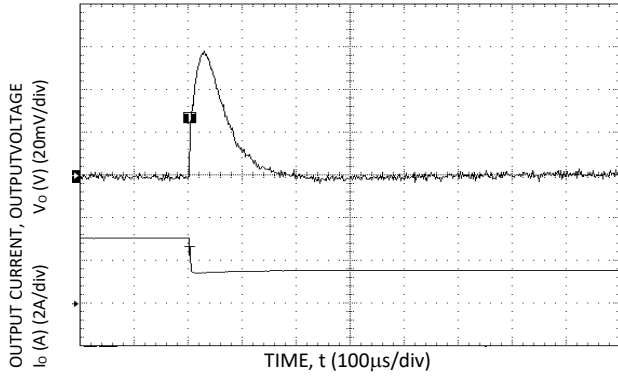

Figure 13. Transient Response to Dynamic Load Change from 100% of 50% full load ($V_o = 3.3Vdc$, $C_{ext} = 2 \times 150 \mu F$ Polymer Capacitors).

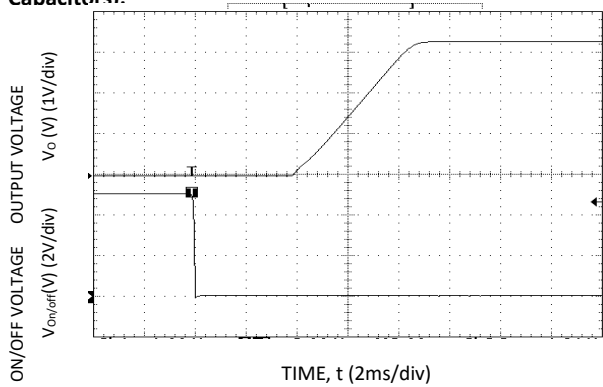

Figure 14. Typical Start-Up Using Remote On/Off ($V_{IN} = 5.0Vdc$, $V_o = 3.3Vdc$, $I_o = 3A$).

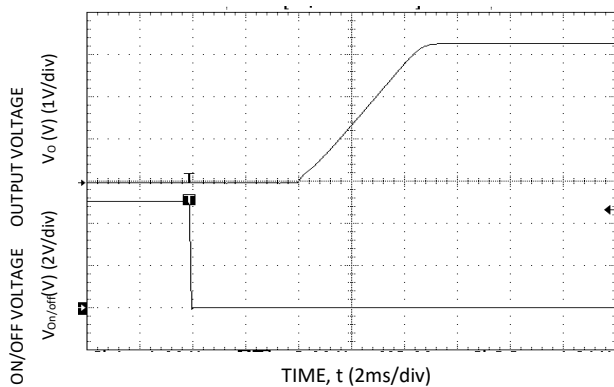

Figure 15. Typical Start-Up Using Remote On/Off with Low-ESR external capacitors (7x150uF Polymer) ($V_{IN} = 5.0Vdc$, $V_o = 3.3Vdc$, $I_o = 3A$, $C_o = 1050\mu F$).

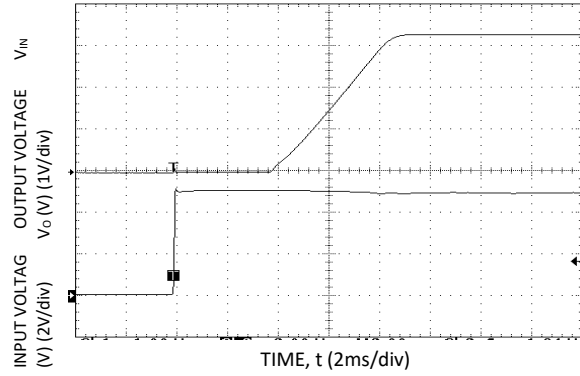

Figure 16. Typical Start-Up with application of V_{in} ($V_{IN} = 5.0Vdc$, $V_o = 3.3Vdc$, $I_o = 3A$).

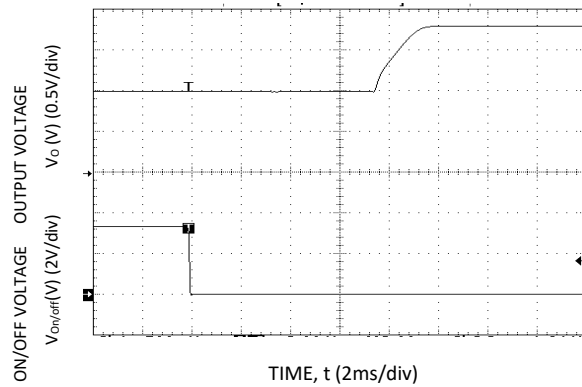

Figure 17 Typical Start-Up Using Remote On/Off with Prebias ($V_{IN} = 3.3Vdc$, $V_o = 1.8Vdc$, $I_o = 1.0A$, $V_{bias} = 1.0Vdc$).

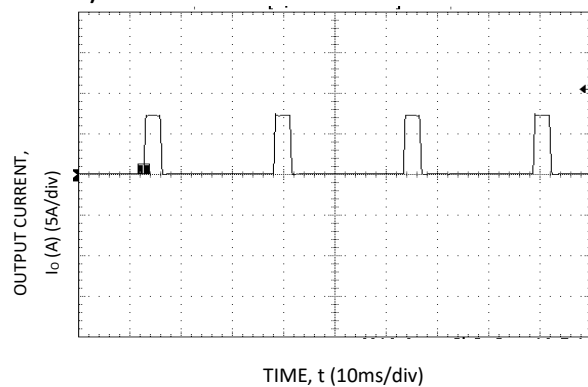

Figure 18. Output short circuit Current ($V_{IN} = 5.0Vdc$, $V_o = 0.75Vdc$).

Austin MiniLynx™: SIP Non-Isolated DC-DC Power Modules

2.4Vdc – 5.5Vdc input; 0.75Vdc to 3.63Vdc output; 3A Output Current

Characteristic Curves (continued)

The following figures provide thermal derating curves for the Austin MiniLynx™ SIP modules.

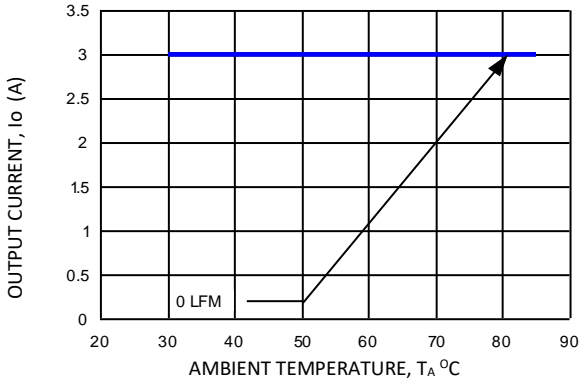

Figure 19. Derating Output Current versus Local Ambient Temperature and Airflow (VIN = 5.0, Vo=3.3Vdc).

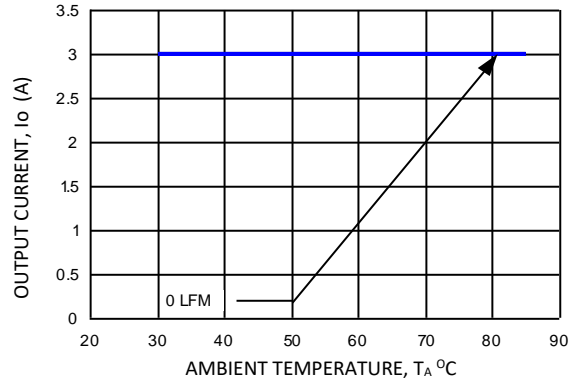

Figure 22. Derating Output Current versus Local Ambient Temperature and Airflow (VIN = 3.3dc, Vo=2.5 Vdc).

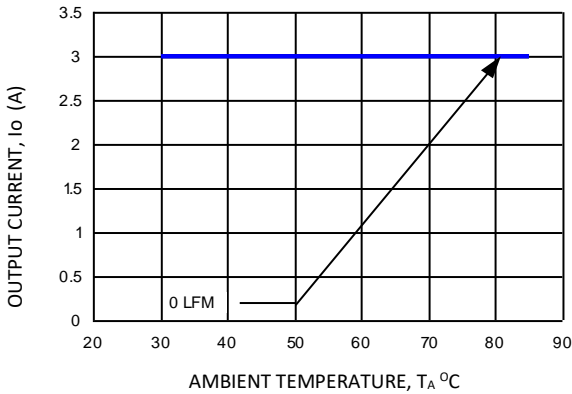

Figure 20. Derating Output Current versus Local Ambient Temperature and Airflow (VIN = 5.0Vdc, Vo=1.8 Vdc).

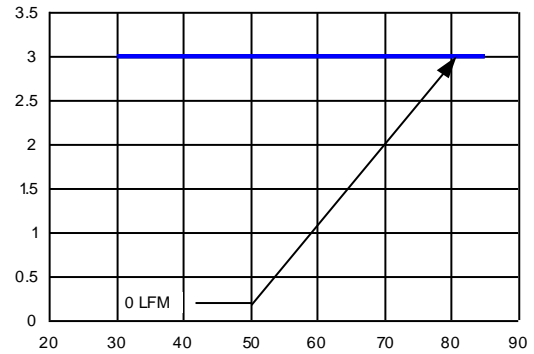

Figure 23. Derating Output Current versus Local Ambient Temperature and Airflow (VIN = 3.3dc, Vo=1.2 Vdc).

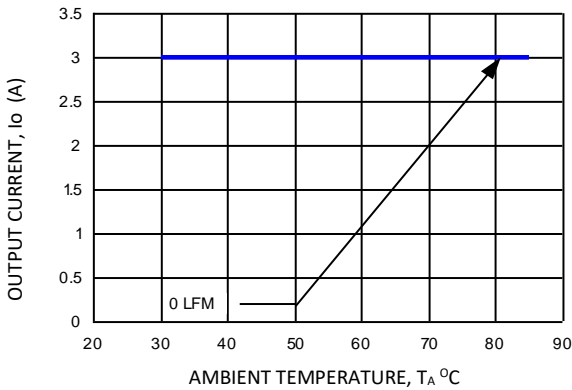

Figure 21. Derating Output Current versus Local Ambient Temperature and Airflow (VIN = 5.0Vdc, Vo=0.75 Vdc).

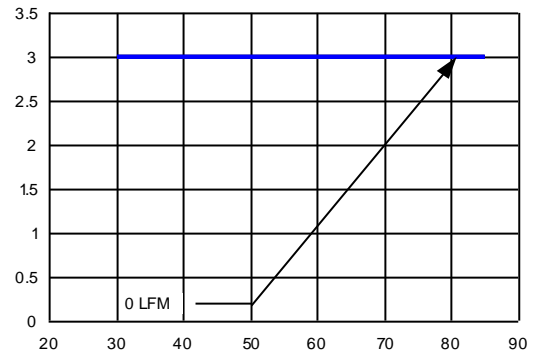
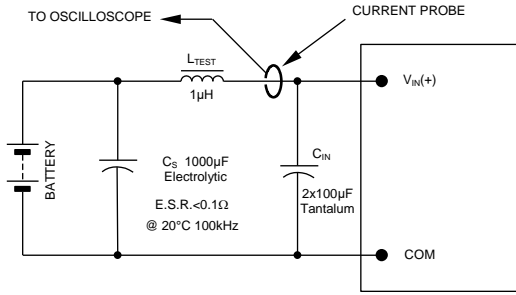

Figure 24. Derating Output Current versus Local Ambient Temperature and Airflow (VIN = 3.3dc, Vo=0.75 Vdc).

Test Configurations

Austin MiniLynx™: SIP Non-Isolated DC-DC Power Modules

2.4Vdc – 5.5Vdc input; 0.75Vdc to 3.63Vdc output; 3A Output Current



NOTE: Measure input reflected ripple current with a simulated source inductance (L_{TEST}) of 1µH. Capacitor C_S offsets possible battery impedance. Measure current as shown above.

Figure 25. Input Reflected Ripple Current Test Setup.

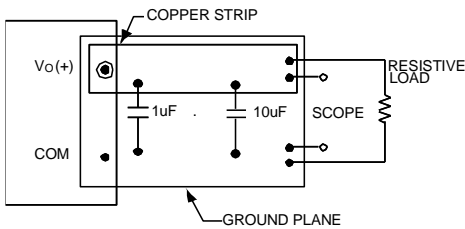

NOTE: All voltage measurements to be taken at the module terminals, as shown above. If sockets are used then Kelvin connections are required at the module terminals to avoid measurement errors due to socket contact resistance.

Figure 26. Output Ripple and Noise Test Setup.

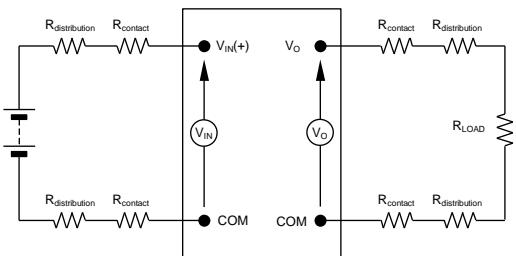

NOTE: All voltage measurements to be taken at the module terminals, as shown above. If sockets are used then Kelvin connections are required at the module terminals to avoid measurement errors due to socket contact resistance.

Figure 27. Output Voltage and Efficiency Test Setup.

$$\text{Efficiency } \eta = \frac{V_O \cdot I_O}{V_{IN} \cdot I_{IN}} \times 100 \%$$

Design Considerations

Input Filtering

The Austin MiniLynx™ SIP module should be connected to a low-impedance source. A highly inductive source can affect the stability of the module. An input capacitance must be placed directly adjacent to the input pin of the module, to minimize input ripple voltage and ensure module stability.

To minimize input voltage ripple, low-ESR polymer and ceramic capacitors are recommended at the input of the module. Figure 28 shows the input ripple voltage (mVp-p) for various outputs with 1x22µF (TDK: C3225X5R0J226V) ceramic capacitor at the input of the module. Figure 29 shows the input ripple with 1x47µF (TDK: C3225X5R0J476M) ceramic capacitor at full load.

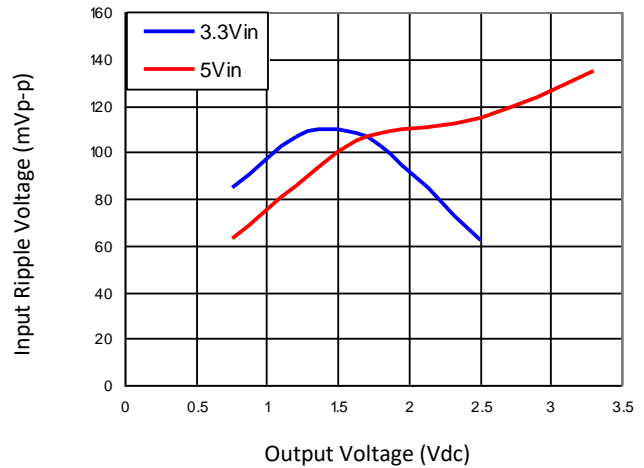

Figure 28. Input ripple voltage for various outputs with 1x22 µF ceramic capacitor at the input (full-load).

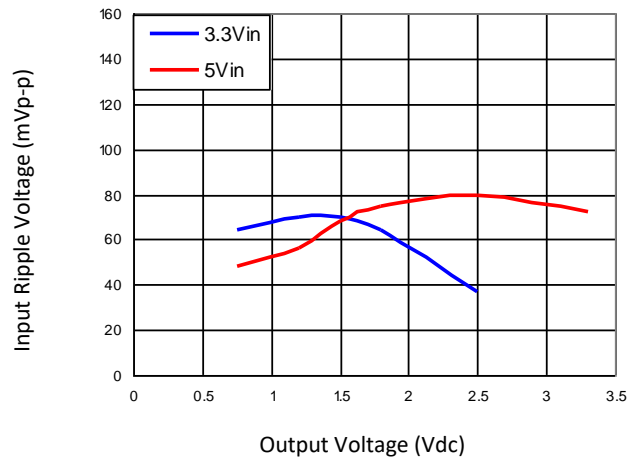

Figure 29. Input ripple voltage for various outputs with 1x47 µF ceramic capacitor at the input (full-load).

Austin MiniLynx™: SIP Non-Isolated DC-DC Power Modules

2.4Vdc – 5.5Vdc input; 0.75Vdc to 3.63Vdc output; 3A Output Current

Design Considerations (continued)

Output Filtering

The Austin MiniLynx™ SIP module is designed for low output ripple voltage and will meet the maximum output ripple specification with 1 μ F ceramic and 10 μ F tantalum capacitors at the output of the module. However, additional output filtering may be required by the system designer for a number of reasons.

First, there may be a need to further reduce the output ripple and noise of the module. Second, the dynamic response characteristics may need to be customized to a particular load step change.

To reduce the output ripple and improve the dynamic response to a step load change, additional capacitance at the output can be used. Low ESR polymer and ceramic capacitors are recommended to improve the dynamic response of the module. For stable operation of the module, limit the capacitance to less than the maximum output capacitance as specified in the electrical specification table.

Safety Considerations

For safety agency approval the power module must be installed in compliance with the spacing and separation requirements of the end-use safety agency standards, i.e., UL ANSI/UL62368-1 and CAN/CSA C22.2 No. 62368-1 Recognized, DIN VDE 0868-1/A11:2017 (EN62368-1:2014/A11:2017).

For the converter output to be considered meeting the Requirements of safety extra-low voltage (SELV) or ES1, the input must meet SELV/ES1 requirements. The power module has extra-low voltage (ELV) outputs when all inputs are ELV.

The input to these units is to be provided with a fast-acting fuse with a maximum rating of 6A in the positive input lead.

Austin MiniLynx™: SIP Non-Isolated DC-DC Power Modules

2.4Vdc – 5.5Vdc input; 0.75Vdc to 3.63Vdc output; 3A Output Current

Feature Description

Remote On/Off

The Austin MiniLynx™ SIP power modules feature an On/Off pin for remote On/Off operation. Two On/Off logic options are available in the Austin MiniLynx™ series modules. Positive Logic On/Off signal, device code suffix “4”, turns the module ON during a logic High on the On/Off pin and turns the module OFF during a logic Low. Negative logic On/Off signal, no device code suffix, turns the module OFF during logic High on the On/Off pin and turns the module ON during logic Low.

For positive logic modules, the circuit configuration for using the On/Off pin is shown in Figure 30. The On/Off pin is an open collector/drain logic input signal ($V_{ON/OFF}$) that is referenced to ground. During a logic-high (On/Off pin is pulled high internal to the module) when the transistor Q1 is in the Off state, the power module is ON. Maximum allowable leakage current of the transistor when $V_{on/off} = V_{IN,max}$ is $10\mu A$. Applying a logic-low when the transistor Q1 is turned-On, the power module is OFF. During this state $V_{On/Off}$ must be less than 0.3V. When not using positive logic On/off pin, leave the pin unconnected or tie to V_{IN} .

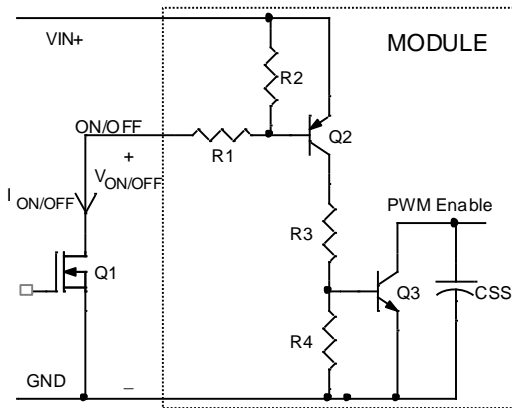

Figure 30. Circuit configuration for using positive logic On/OFF.

For negative logic On/Off devices, the circuit configuration is shown in Figure 31. The On/Off pin is pulled high with an external pull-up resistor (typical $R_{pull-up} = 5k, +/- 5\%$). When transistor Q1 is in the Off state, logic High is applied to the On/Off pin and the power module is Off. The minimum On/off voltage for logic High on the On/Off pin is 1.5Vdc. To turn the module ON, logic Low is applied to the On/Off pin by turning ON Q1. When not using the negative logic On/Off, leave the pin unconnected or tie to GND.

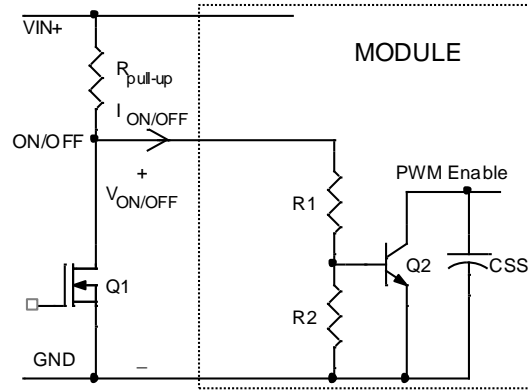

Figure 31. Circuit configuration for using negative logic On/OFF.

Overcurrent Protection

To provide protection in a fault (output overload) condition, the unit is equipped with internal current-limiting circuitry and can endure current limiting continuously. At the point of current-limit inception, the unit enters hiccup mode. The unit operates normally once the output current is brought back into its specified range. The typical average output current during hiccup is 3.5A.

Input Undervoltage Lockout

At input voltages below the input undervoltage lockout limit, module operation is disabled. The module will begin to operate at an input voltage above the undervoltage lockout turn-on threshold.

Overtemperature Protection

To provide over temperature protection in a fault condition, the unit relies upon the thermal protection feature of the controller IC. The unit will shutdown if the thermal reference point T_{ref} exceeds $140^{\circ}C$ (typical), but the thermal shutdown is not intended as a guarantee that the unit will survive temperatures beyond its rating. The module will automatically restart after it cools down.

Austin MiniLynx™: SIP Non-Isolated DC-DC Power Modules

2.4Vdc – 5.5Vdc input; 0.75Vdc to 3.63Vdc output; 3A Output Current

Feature Descriptions (continued)

Output Voltage Programming

The output voltage of the Austin MiniLynx™ SIP can be programmed to any voltage from 0.75 Vdc to 3.63 Vdc by connecting a single resistor (shown as R_{trim} in Figure 32) between the TRIM and GND pins of the module. Without an external resistor between TRIM pin and the ground, the output voltage of the module is 0.7525 Vdc. To calculate the value of the resistor R_{trim} for a particular output voltage V_o , use the following equation:

$$R_{trim} = \left[\frac{21070}{V_o - 0.7525} - 5110 \right] \Omega$$

For example, to program the output voltage of the Austin MiniLynx™ module to 1.8 Vdc, R_{trim} is calculated as follows:

$$R_{trim} = \left[\frac{21070}{1.8 - 0.7525} - 5110 \right]$$

$$R_{trim} = 15.004k\Omega$$

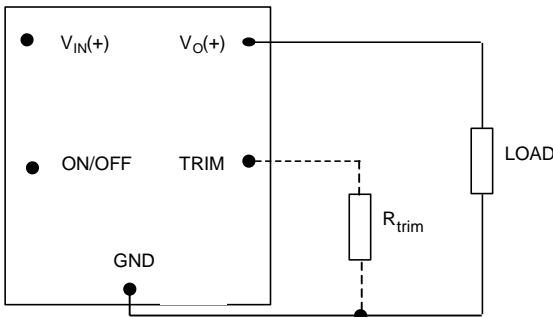

Figure 32. Circuit configuration to program output voltage using an external resistor.

Table 1 provides R_{trim} values required for some common output voltages.

Table 1

$V_{o, set}$ (V)	R_{trim} (KΩ)
0.7525	Open
1.2	41.973
1.5	23.077
1.8	15.004
2.5	6.947
3.3	3.160

By using a 1% tolerance trim resistor, set point tolerance of $\pm 2\%$ is achieved as specified in the electrical specification. The POL Programming Tool, available at www.gecriticalpower.com under the Design Tools section, helps determine the required external trim resistor needed for a specific output voltage.

Voltage Margining

Output voltage margining can be implemented in the Austin MiniLynx™ modules by connecting a resistor, $R_{margin-up}$, from the Trim pin to the ground pin for margining-up the output voltage and by connecting a resistor, $R_{margin-down}$, from the Trim pin to the Output pin for margining-down. Figure 33 shows the circuit configuration for output voltage margining. The POL Programming Tool, available at www.gecriticalpower.com under the Design Tools section, also calculates the values of $R_{margin-up}$ and $R_{margin-down}$ for a specific output voltage and % margin. Please consult your local GE technical representative for additional details.

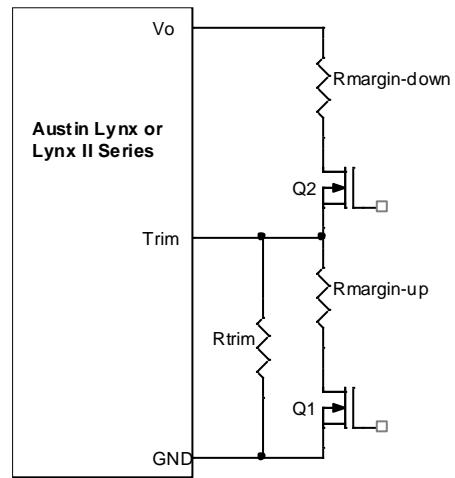

Figure 33. Circuit Configuration for margining Output voltage.

Austin MiniLynx™: SIP Non-Isolated DC-DC Power Modules

2.4Vdc – 5.5Vdc input; 0.75Vdc to 3.63Vdc output; 3A Output Current

Thermal Considerations

Power modules operate in a variety of thermal environments; however, sufficient cooling should always be provided to help ensure reliable operation.

Considerations include ambient temperature, airflow, module power dissipation, and the need for increased reliability. A reduction in the operating temperature of the module will result in an increase in reliability. The thermal data presented here is based on physical measurements taken in a wind tunnel. The test set-up is shown in Figure 35. Note that the airflow is parallel to the long axis of the module as shown in figure 34. The derating data applies to airflow in either direction of the module’s long axis.

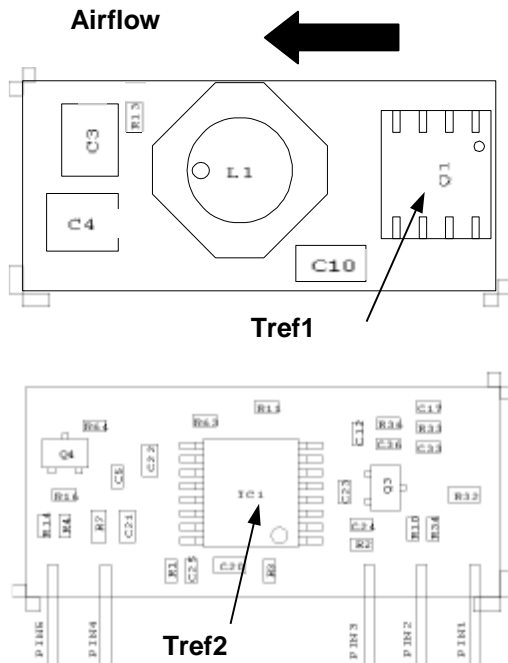

Figure 34. T_{ref} Temperature measurement location.

The thermal reference point, T_{ref} used in the specifications is shown in Figure 34. For reliable operation this temperature should not exceed 115°C.

The output power of the module should not exceed the rated power of the module (V_{o,set} x I_{o,max}).

Please refer to the Application Note “Thermal Characterization Process For Open-Frame Board-Mounted Power Modules” for a detailed discussion of thermal aspects including maximum device temperatures.

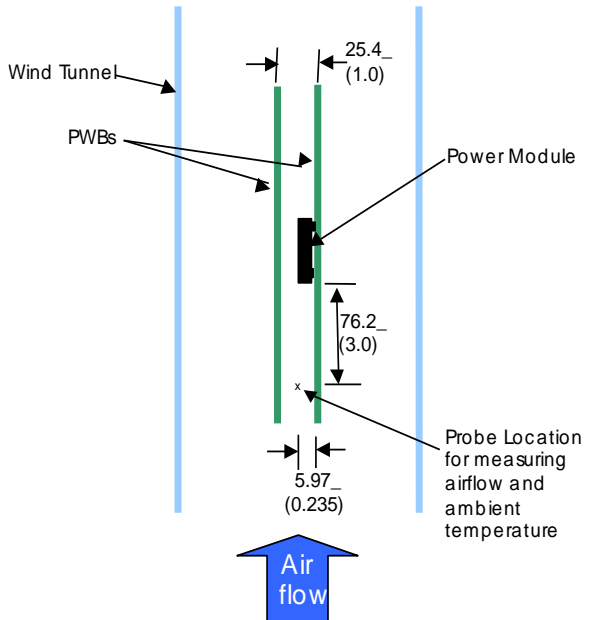

Figure 35. Thermal Test Set-up.

Austin MiniLynx™: SIP Non-Isolated DC-DC Power Modules

2.4Vdc – 5.5Vdc input; 0.75Vdc to 3.63Vdc output; 3A Output Current

Post solder Cleaning and Drying Considerations

Post solder cleaning is usually the final circuit-board assembly process prior to electrical board testing. The result of inadequate cleaning and drying can affect both the reliability of a power module and the testability of the finished circuit-board assembly. For guidance on appropriate soldering, cleaning and drying procedures, refer to *Board Mounted Power Modules: Soldering and Cleaning* Application Note.

Through-Hole Lead-Free Soldering Information

The RoHS-compliant through-hole products use the SAC (Sn/Ag/Cu) Pb-free solder and RoHS-compliant components. They are designed to be processed through single or dual wave soldering machines. The pins have an RoHS-compliant finish that is compatible with both Pb and Pb-free wave soldering processes. A maximum preheat rate of 3°C/s is suggested. The wave preheat process should be such that the temperature of the power module board is kept below 210°C. For Pb solder, the recommended pot temperature is 260°C, while the Pb-free solder pot is 270°C max. Not all RoHS-compliant through-hole products can be processed with paste-through-hole Pb or Pb-free reflow process. If additional information is needed, please consult with your GE technical representative for more details.

Austin MiniLynx™: SIP Non-Isolated DC-DC Power Modules

2.4Vdc – 5.5Vdc input; 0.75Vdc to 3.63Vdc output; 3A Output Current

Mechanical Outline

Dimensions are in millimeters and (inches).

Tolerances: x.x mm ± 0.5 mm (x.xx in. ± 0.02 in.) [unless otherwise indicated]

x.xx mm ± 0.25 mm (x.xxx in ± 0.010 in.)

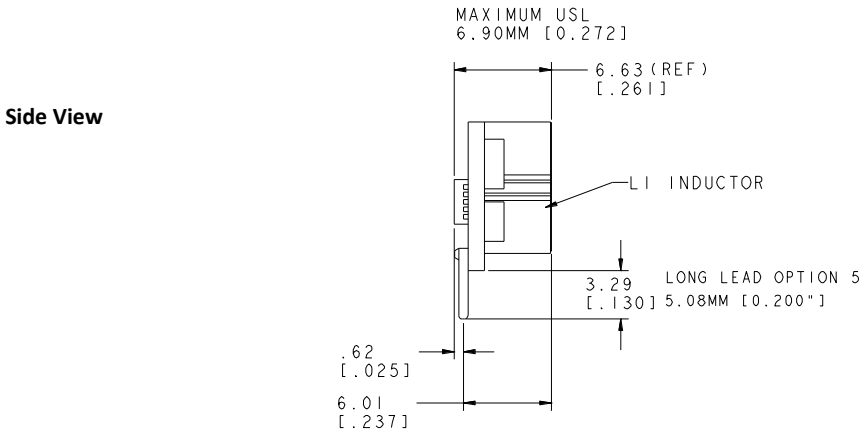
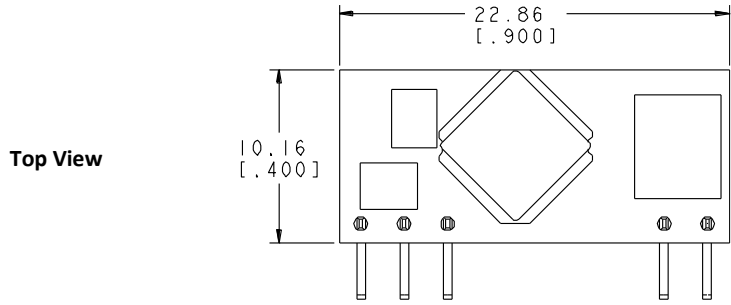

PIN	FUNCTION
1	Vo
2	Trim
3	GND
4	VIN
5	On/Off

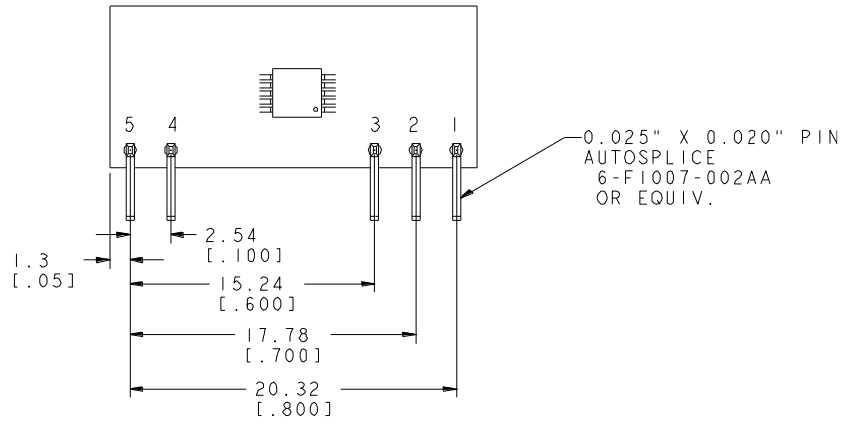

Austin MiniLynx™: SIP Non-Isolated DC-DC Power Modules

2.4Vdc – 5.5Vdc input; 0.75Vdc to 3.63Vdc output; 3A Output Current

Recommended Pad Layout

Dimensions are in millimeters and (inches).

Tolerances: x.x mm ± 0.5 mm (x.xx in. ± 0.02 in.) [unless otherwise indicated]

x.xx mm ± 0.25 mm (x.xxx in ± 0.010 in.)

PIN	FUNCTION
1	Vo
2	Trim
3	GND
4	VIN
5	On/Off

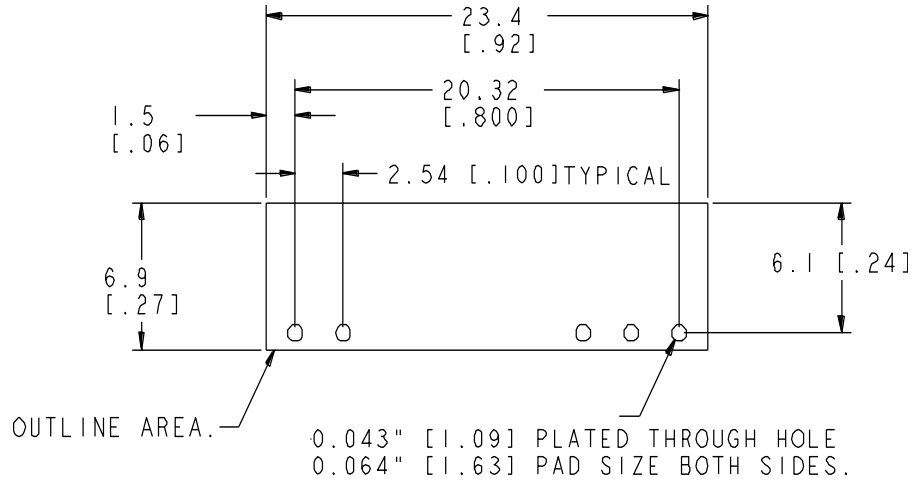

Component side view

12V Austin MiniLynx™: SIP Non-Isolated DC-DC Power Modules

8.3Vdc –14Vdc input; 0.75Vdc to 5.5Vdc output; 3A Output Current

Ordering Information

Please contact your GE Sales Representative for pricing, availability and optional features.

Table 3. Device Codes

Device Code	Input Voltage Range	Output Voltage	Output Current	Efficiency 3.3V@ 3A	On/Off Logic	Connector Type	Comcodes
AXH003A0X-Z	2.4 – 5.5Vdc	0.75 – 3.63Vdc	3 A	94.0 %	Negative	SIP	CC109104865
AXH003A0X4-Z	2.4 – 5.5Vdc	0.75 – 3.63Vdc	3 A	94.0 %	Positive	SIP	CC109104873

-Z refers to RoHS compliant Versions

Contact Us

For more information, call us at

USA/Canada:

+1 877 546 3243, or +1 972 244 9288

Asia-Pacific:

+86-21-53899666

Europe, Middle-East and Africa:

+49.89.878067-280

Go.ABB/Industrial



GE Critical Power reserves the right to make changes to the product(s) or information contained herein without notice, and no liability is assumed as a result of their use or application. No rights under any patent accompany the sale of any such product(s) or information.