

Features

- 4:1 wide input voltage range
- 1.6kVDC isolation
- UL certified
- Efficiency up to 88%
- Six-sided continuous shield
- Available as power module (RPM30-EW)

Regulated Converter



RP30-EW

30 Watt
2" x 1.6"
Single and Dual Output



Description

The RP30-EW series wide input range DC/DC converters are certified to UL 60950-1 and to cUL 60950-1. This makes them ideal for all telecom and industrial applications where approved safety standards are required. The industry standard 2" x 1.6" package meets military standards for thermal shock and vibration tolerance.

Selection Guide

Part Number	Input Voltage Range [VDC]	Output Voltage [VDC]	Output Current [mA]	Input ⁽¹⁾ Current [mA]	Efficiency ⁽¹⁾ typ. [%]	Max. Capacitive Load ⁽²⁾ [µF]
RP30-243.3SEW ^(3,4)	10-40	3.3	6000	948	87	19500
RP30-2405SEW ^(3,4)	10-40	5	6000	1437	87	10200
RP30-2412SEW ^(3,4)	10-40	12	2500	1437	87	3300
RP30-2415SEW ^(3,4)	10-40	15	2000	1420	88	1100
RP30-483.3SEW ^(3,4)	18-75	3.3	6000	474	87	19500
RP30-4805SEW ^(3,4)	18-75	5	6000	710	88	10200
RP30-4812SEW ^(3,4)	18-75	12	2500	718	87	3300
RP30-4815SEW ^(3,4)	18-75	15	2000	710	88	1100
RP30-2412DEW ^(3,4)	10-40	±12	±1250	1488	84	±1000
RP30-2415DEW ^(3,4)	10-40	±15	±1000	1471	85	±680
RP30-4812DEW ^(3,4)	18-75	±12	±1250	735	85	±1000
RP30-4815DEW ^(3,4)	18-75	±15	±1000	726	86	±680

Notes:

- Note1: Maximum values at nominal input voltage and full load
 Note2: Max. Cap load is tested at minimum input and constant resistive load

Model Numbering

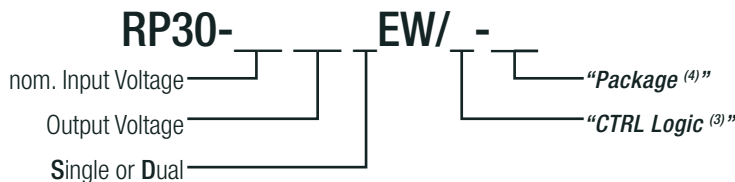

Notes:

- Note3: no suffix for CTRL function with Positive Logic (1=ON, 0=OFF)
 add suffix "N" for CTRL function with Negative Logic (0=ON, 1=OFF)
 Note4: add suffix "-HC" for premounted Heat-sink with clips

Ordering Examples

- RP30-2405SEW = 24V Input, 5V Output, Single, Positive Logic CTRL pin
 RP30-4812DEW/N-HC = 48V Input, ±12V Output, Dual, Negative Logic CTRL pin, Heat-sink premounted

Specifications (measured @ Ta= 25°C, nom. Vin, full load unless otherwise stated)

BASIC CHARACTERISTICS					
Parameter	Condition		Min.	Typ.	Max.
Input Filter ⁽⁶⁾					LC Type
Input Voltage Range	nom. Vin = 24VDC nom. Vin = 48VDC		10VDC 18VDC	24VDC 48VDC	40VDC 75VDC
Input Surge Voltage	100ms max.	nom. Vin = 24VDC nom. Vin = 48VDC			50VDC 100VDC
Under Voltage Lockout (UVLO)	nom. Vin = 24VDC	DC-DC ON DC-DC OFF		8VDC	10VDC
	nom. Vin = 48VDC	DC-DC ON DC-DC OFF		16VDC	18VDC
Output Voltage Trimming	refer to „ <i>OUTPUT VOLTAGE TRIMMING</i> “		-10%		+10%
Input Reflected Ripple Current ⁽⁶⁾				20mA _{p-p}	
Minimum Load ⁽⁷⁾	% of full load	Single	0%		
		Dual	10%		
Start-up Time	Power up ON/OFF CTRL			10ms 10ms	
	ON/OFF CTRL ⁽⁸⁾	Positive Logic	DC-DC ON DC-DC OFF	Open or 3.0VDC < V _{CTRL} < 12VDC Short or 0VDC < V _{CTRL} < 1.2VDC	
	Negative Logic	DC-DC ON DC-DC OFF	Short or 0VDC < V _{CTRL} < 1.2VDC Open or 3.0VDC < V _{CTRL} < 12VDC		
Input Current of CTRL pin	DC-DC ON		-0.5mA		+0.5mA
Standby Current	DC-DC OFF			3mA	
Internal Operating Frequency			270kHz	300kHz	330kHz
Ripple and Noise	measured at 20MHz BW with a 0.1µF/50V MLCC	Others		60mV _{p-p}	
		5V _{out} 12V _{out} , 15V _{out}		75mV _{p-p} 100mV _{p-p}	

Notes:

- Note5: An external filter capacitor is required for normal operation. The capacitor should be capable of handling 1A ripple current for 48V/24V models. RECOM suggest: Nippon chemi-con KY series, 220µF/100V, ESR 90mΩ
- Note6: Simulated source impedance of 12µH. 12µH inductor in series with +Vin.
- Note7: The dual output required a minimum 10% loading on the output to maintain specified regulation. Operation under no-load condition will not damage these devices, however they may not meet all listed specification
- Note8: The ON/OFF control function can be positive or negative logic. The pin voltage is referenced to -Vin pin

RP30-2405SE

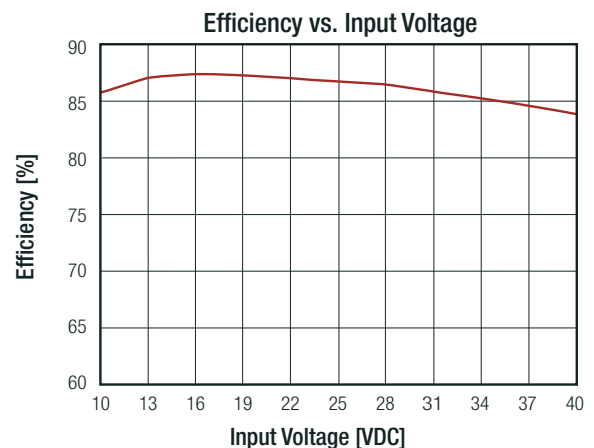
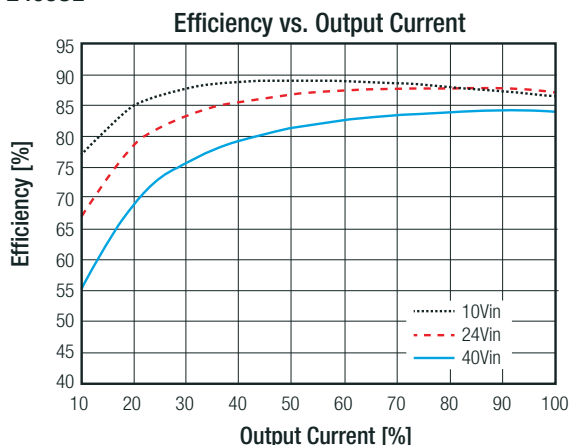

continued on next page

Specifications (measured @ Ta= 25°C, nom. Vin, full load unless otherwise stated)

RP30-4805SEW

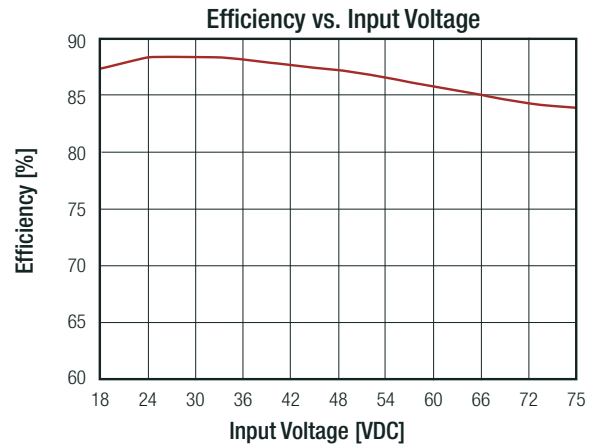
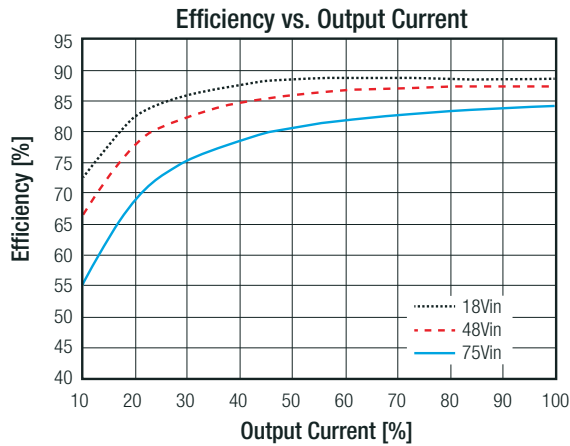

OUTPUT VOLTAGE TRIMMING

Output Voltage Trimming

Some single/dual output Powerline converters offer the feature of trimming the output voltage over a certain range around the nominal value by using external trim resistors. No general equation can be given for calculating the trim resistors, but the following trimtables give typical values for choosing these trimming resistors. If voltages between the given trim points are required, extrapolate between the two nearest given values to work out the resistor required or use a variable resistor to set the output voltage. Output can be externally trimmed by using the method shown below.

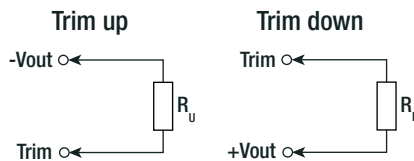

RP30-xx3.3SEW

Trim up	1	2	3	4	5	6	7	8	9	10	[%]
Vout =	3.333	3.366	3.399	3.432	3.465	3.498	3.531	3.564	3.597	3.63	[VDC]
R _u =	57.93	26.16	15.58	10.28	7.11	4.99	3.48	2.34	1.46	0.75	[kΩ]

Trim down	1	2	3	4	5	6	7	8	9	10	[%]
Vout =	3.267	3.234	3.201	3.168	3.135	3.102	3.069	3.036	3.003	2.97	[VDC]
R _b =	69.47	31.23	18.49	12.12	8.29	5.74	3.92	2.56	1.50	0.65	[kΩ]

RP30-xx05SEW

Trim up	1	2	3	4	5	6	7	8	9	10	[%]
Vout =	5.05	5.10	5.15	5.20	5.25	5.30	5.35	5.4	5.45	5.50	[VDC]
R _u =	36.57	16.58	9.92	6.58	4.59	3.25	2.30	1.59	1.03	0.59	[kΩ]

Trim down	1	2	3	4	5	6	7	8	9	10	[%]
Vout =	4.95	4.90	4.85	4.80	4.75	4.70	4.65	4.60	4.55	4.50	[VDC]
R _b =	45.53	20.61	12.31	8.15	5.66	4.00	2.81	1.92	1.23	0.68	[kΩ]

continued on next page

Specifications (measured @ Ta= 25°C, nom. Vin, full load unless otherwise stated)

RP30-xx12SEW											
Trim up	1	2	3	4	5	6	7	8	9	10	[%]
Vout =	12.12	12.24	12.36	12.48	12.60	12.72	12.84	12.96	13.08	13.20	[VDC]
R _u =	367.91	165.95	98.64	64.98	44.78	31.32	21.70	14.49	8.88	4.39	[kΩ]
Trim down	1	2	3	4	5	6	7	8	9	10	[%]
Vout =	11.88	11.76	11.64	11.52	11.40	11.28	11.16	11.04	10.92	10.8	[VDC]
R _b =	460.99	207.95	123.60	81.42	56.12	39.25	27.20	18.16	11.13	5.51	[kΩ]
RP30-xx15SEW											
Trim up	1	2	3	4	5	6	7	8	9	10	[%]
Vout =	15.15	15.3	15.45	15.60	15.75	15.90	16.05	16.20	16.35	16.50	[VDC]
R _u =	404.18	180.59	106.06	68.80	46.44	31.53	20.88	12.90	6.69	1.72	[kΩ]
Trim down	1	2	3	4	5	6	7	8	9	10	[%]
Vout =	14.85	14.70	14.55	14.40	14.25	14.10	13.95	13.80	13.65	13.50	[VDC]
R _b =	499.82	223.41	131.27	85.20	57.56	39.14	25.97	16.10	8.42	2.282	[kΩ]
RP30-xx12DEW											
Trim up	1	2	3	4	5	6	7	8	9	10	[%]
Vout =	24.24	24.48	24.72	24.96	25.20	25.44	25.68	25.92	26.16	26.40	[VDC]
R _u =	218.21	98.10	58.07	38.05	26.04	18.03	12.32	8.03	4.69	2.02	[kΩ]
Trim down	1	2	3	4	5	6	7	8	9	10	[%]
Vout =	23.76	23.52	23.28	23.04	22.80	22.56	22.32	22.08	21.84	21.6	[VDC]
R _b =	273.44	123.02	72.87	47.80	32.76	22.73	15.57	10.20	6.02	2.67	[kΩ]
RP30-xx15DEW											
Trim up	1	2	3	4	5	6	7	8	9	10	[%]
Vout =	30.30	30.60	30.90	31.20	31.50	31.80	32.10	32.40	32.70	33.00	[VDC]
R _u =	268.29	120.64	71.43	46.82	32.06	22.21	15.10	9.91	5.81	2.53	[kΩ]
Trim down	1	2	3	4	5	6	7	8	9	10	[%]
Vout =	29.70	29.40	29.10	28.80	28.50	28.20	27.90	27.60	27.30	27.00	[VDC]
R _b =	337.71	152.02	90.13	59.18	40.61	28.23	19.39	12.76	7.60	3.47	[kΩ]

REGULATIONS			
Parameter	Condition	Value	
Output Accuracy		±1.0%	
Line Regulation	low line to high line, full load	±0.5%	
Load Regulation ⁽⁷⁾	0% to 100% load	Single	±0.5%
		Dual	±1.0%
Cross Regulation	asymmetrical 25%<>100% load	±5.0%	
Transient Response Recovery Time	25% load step change	250µs typ.	

Specifications (measured @ Ta= 25°C, nom. Vin, full load unless otherwise stated)

PROTECTIONS			
Parameter	Condition		Value
Short Circuit Protection (SCP)			continuous, automatic recovery
Over Voltage Protection (OVP)	zener diode clamp	3.3Vout	3.9VDC
		5Vout	6.2VDC
		12Vout	15VDC
		15Vout	18VDC
Over Load Protection (OLP)	% of lout rated		150% typ.
Over Temperature Protection (OTP)			115°C typ.
Isolation Voltage ⁽⁹⁾	I/P to O/P		1.6kVDC/ 1 minute
	I/P to O/P to case		1.6kVDC/ 1 minute
Isolation Resistance	Viso= 500VDC		1GΩ min.
Isolation Capacitance			1000pF max.
Notes:			
Note9: For repeat Hi-Pot testing, reduce the time and/or the test voltage			
Note10: This power module is not internally fused. An input line fuse must always be used			

ENVIRONMENTAL			
Parameter	Condition		Value
Operating Temperature Range	without derating		-40°C to +70°C
	with derating		-40°C to +100°C
Maximum Case Temperature			+100°C
Temperature Coefficient			±0.02%/K max.
Thermal Impedance	@ natural convection	without heat-sink	10K/W
	0.1m/s	with heat-sink	8.24K/W
Operating Humidity	non-condensing		5% - 95% RH
Thermal Shock			according to MIL-STD-810F
Vibration			according to MIL-STD-810F
MTBF	MIL-HDBK-217F, G.B.		759.8 x 10 ³ hours
	Bellcore TR-NWT-000332 ⁽¹¹⁾		1315 x 10 ³ hours

Derating Graph ⁽¹²⁾

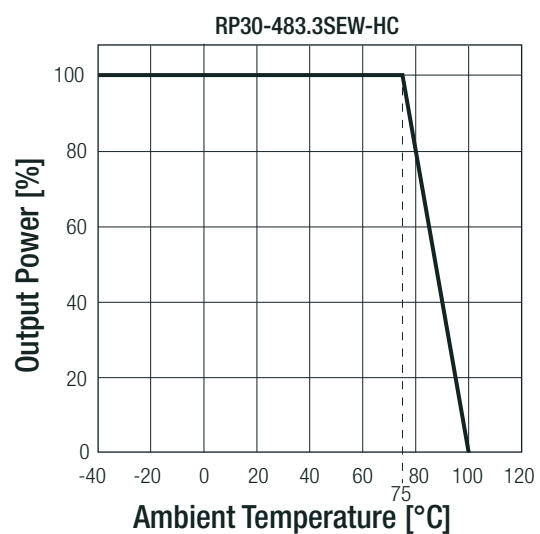
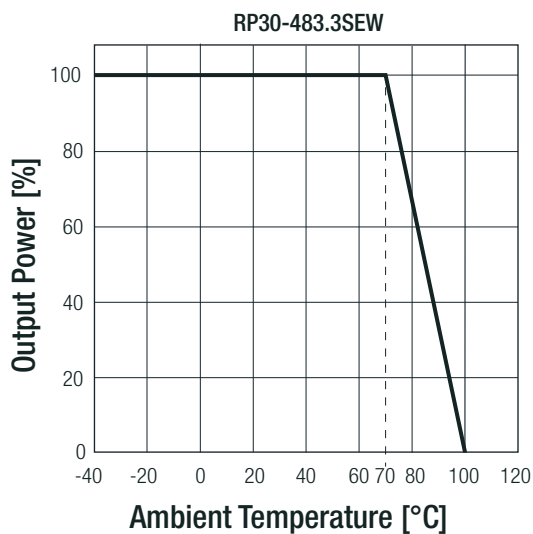

Notes:

Note11: BELLCORE TR-NWT-000332. Case I: 50% Stress, Temperature at 40°C (Ground fixed and controlled environment)

Note12: Derating graphs are valid only for the shown part numbers. If you need detailed derating-information about a part-number not shown here please contact RECOM Techsupport for detailed information

Specifications (measured @ Ta= 25°C, nom. Vin, full load unless otherwise stated)

SAFETY AND CERTIFICATIONS

Certificate Type (Safety)	Condition	Standard
Information Technology Equipment, General Requirements for Safety	E196683	UL60950-1, 2nd Edition 2011 CAN/CSA-C22.2 No. 60950-1, 2nd Edition 2011
EAC	RU-AT.49.09571	TP TC 004/2011
RoHS2		RoHS-2011/65/EU + AM-2015/863

EMC Compliance

Condition	Standard / Criterion
Electromagnetic compatibility of multimedia equipment - Emission requirements	EN55032, Class A and B
ESD Electrostatic discharge immunity test	EN61000-4-2, Criteria B
Radiated, radio-frequency, electromagnetic field immunity test	EN61000-4-3, Criteria A
Fast Transient and Burst Immunity ⁽¹³⁾	EN61000-4-4, Criteria A
Surge Immunity ⁽¹³⁾	EN61000-4-5, Criteria B
Immunity to conducted disturbances, induced by radio-frequency fields	EN61000-4-6, Criteria A
Power Magnetic Field Immunity	EN61000-4-8, Criteria A

Notes:

Note13: An external input filter capacitor is required if the module has to meet EN61000-4-4, EN61000-4-5. The filter capacitor Recom suggests: Nippon chemi-con KY series 220µF/100V

EMC Filtering Suggestions according to EN55032

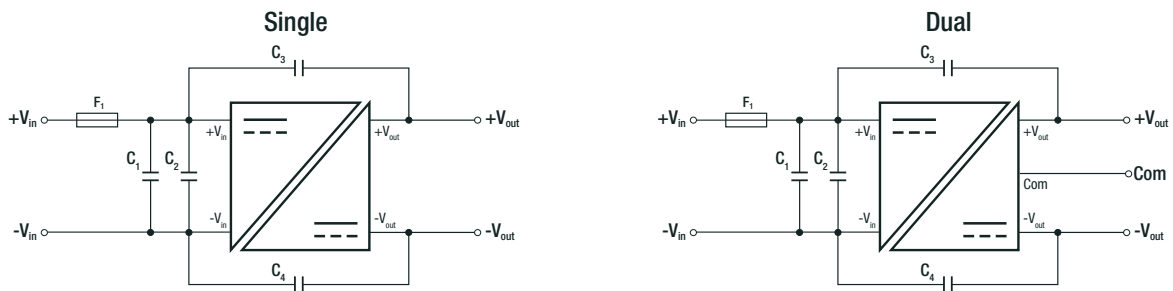

Component List Class A

MODEL	C1	C2	C3/C4
RP30-24xxSE RP30-24xxDE	6.8µF/50V, 1812 MLCC	N/A	1000pF/2kV, 1808 MLCC
RP30-48xxSE RP30-48xxDE	2.2µF/100V, 1812 MLCC	2.2µF/100V, 1812 MLCC	1000pF/2kV, 1808 MLCC

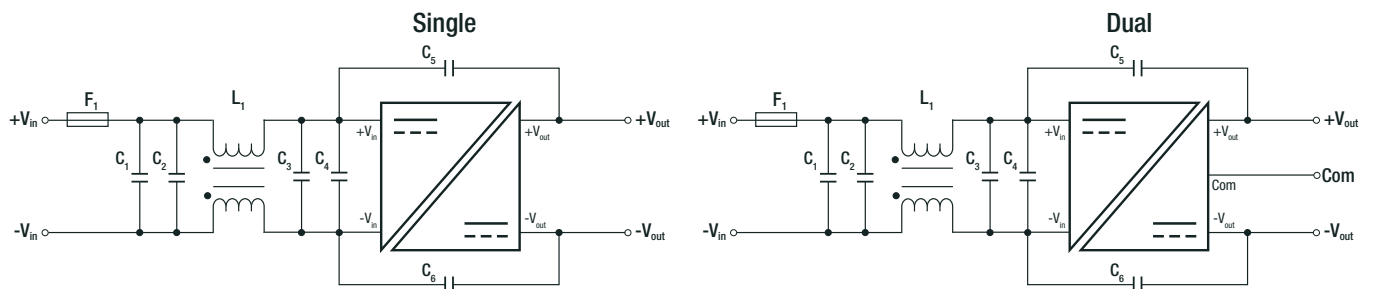

Component List Class B

MODEL	C1	C2	C3	C4	C5/C6	L1
RP30-24xxSE RP30-24xxDE	6.8µF/50V 1812 MLCC	N/A	6.8µF/50V 1812 MLCC	N/A	1000pF/2kV 1808 MLCC	CMC: 450µH ref.: WE 7448227005 or ref.: CMC-05
RP30-48xxSE RP30-48xxDE	2.2µF/100V 1812 MLCC	2.2µF/100V 1812 MLCC	2.2µF/100V 1812 MLCC	2.2µF/100V 1812 MLCC	1000pF/2kV 1808 MLCC	CMC: 450µH ref.: WE 7448227005 or ref.: CMC-05

Specifications (measured @ Ta= 25°C, nom. Vin, full load unless otherwise stated)

DIMENSIONS and PHYSICAL CHARACTERISTICS

Parameter	Type	Value
Material	case	nickel coated copper
	base	FR4 PCB
	potting	epoxy (UL94-V0)
Dimensions (LxWxH)	without Heat-sink	50.8 x 40.6 x 10.2mm
	with Heat-sink	56.8 x 40.6 x 17.0mm
Weight	without Heat-sink	48.0g
	with Heat-sink	69.06g

Dimension Drawing (mm)

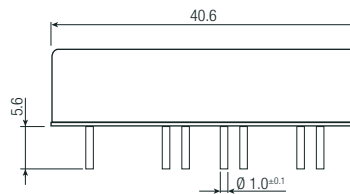
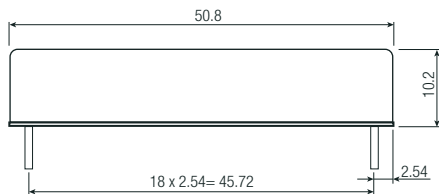
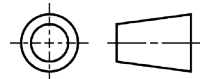

Pinning Information

Pin #	Single	Dual
1	+Vin	+Vin
2	-Vin	-Vin
4	CTRL ⁽³⁾	CTRL ⁽³⁾
5	no Pin	+Vout
6	+Vout	Com
7	-Vout	-Vout
8	Trim	Trim

Pin Pitch Tolerance ±0.25mm
 xx.x = ±0.5mm
 xx.xx = ±0.25mm

Recommended Footprint Details

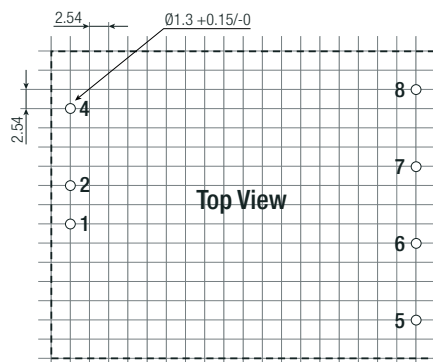
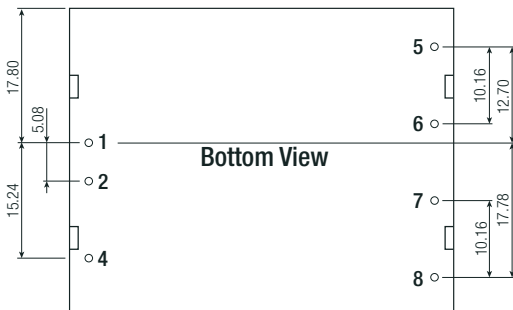

continued on next page

Specifications (measured @ Ta= 25°C, nom. Vin, full load unless otherwise stated)

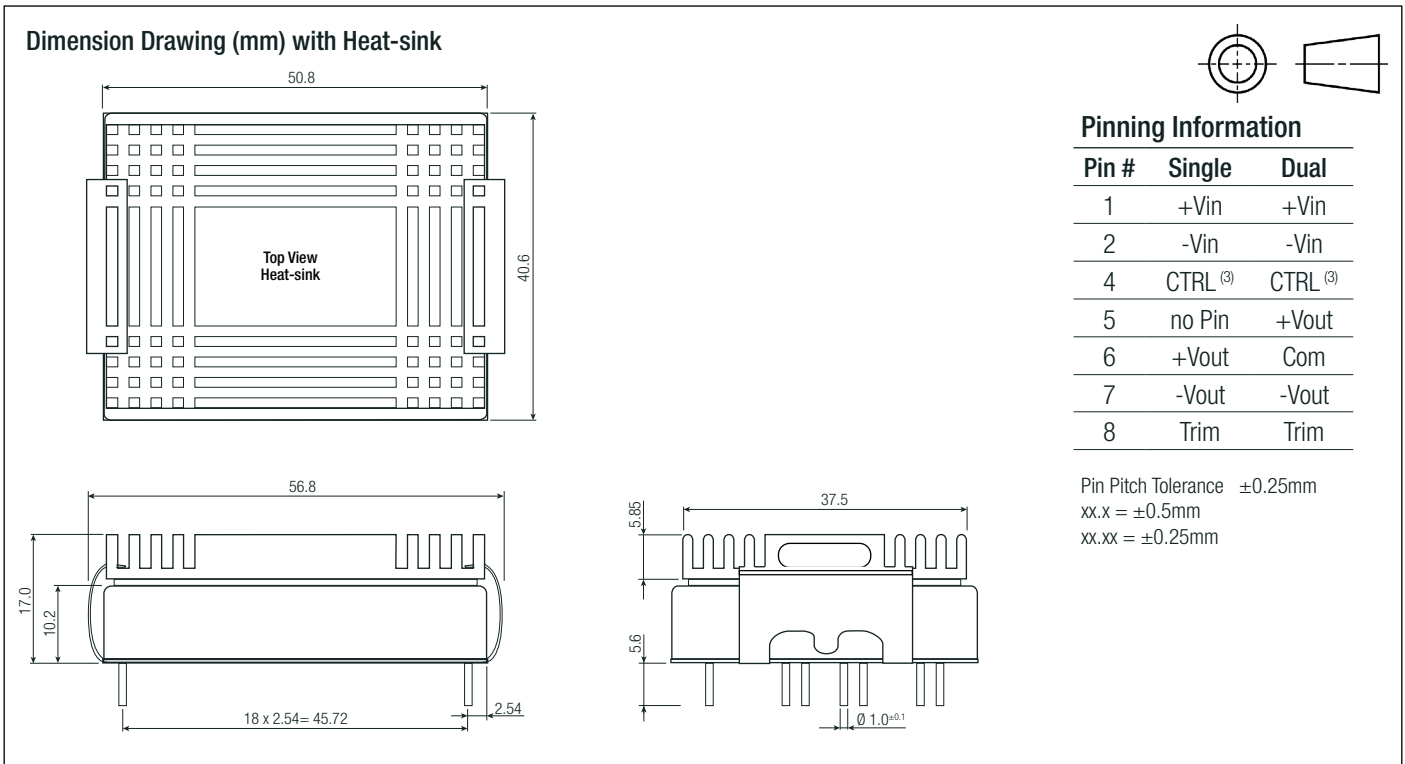

PACKAGING INFORMATION			
Parameter	Type		Value
Packaging Dimension (LxWxH)	tube	without heat-sink	255.0 x 54.0 x 22.0mm
	tray	with heat-sink	302.5 x 222.0 x 20.0mm
Packaging Quantity	tube	without heat-sink	5pcs
	tray	with heat-sink	15pcs
Storage Temperature Range			-55°C to +125°C
Storage Humidity	non-condensing		5% - 95% RH

The product information and specifications may be subject to changes even without prior written notice. The product has been designed for various applications; its suitability lies in the responsibility of each customer. The products are not authorized for use in safety-critical applications without RECOM's explicit written consent. A safety-critical application is an application where a failure may reasonably be expected to endanger or cause loss of life, inflict bodily harm or damage property. The applicant shall indemnify and hold harmless RECOM, its affiliated companies and its representatives against any damage claims in connection with the unauthorized use of RECOM products in such safety-critical applications.