

**RoHS compliant**

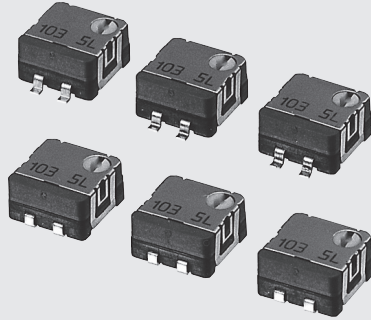

**FEATURES**

- RoHS compliant
- Fine adjustment is possible
- Automatic mounting is possible (Taping)
- Flow/reflow soldering is possible
- Sealed construction (Washable: Refer to page 698.)

**INTERNAL STRUCTURE**

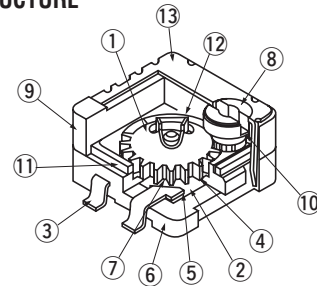

	Part name	Material	Flammability
①	Rotor gear	Polyphenylenesulphide	UL94V-0
②	Base element	Ceramic	—
③	Terminal pin	Copper alloy, Sn-Cu-plated	
④	Resistive element	RuO <sub>2</sub> cermet	
⑤	Electrode	Ag-Pd cermet	
⑥	Housing base	Polyphenylenesulphide	UL94V-0
⑦	Wiper	Multi metal alloy	—
⑧	Shaft	Polyphenylenesulphide	UL94V-0
⑨	Housing		
⑩	Shaft "O" ring	Silicone rubber	UL94HB
⑪	Base "O" ring		
⑫	Clutch spring	Stainless steel	—
⑬	Cover		

**PART NUMBER DESIGNATION**

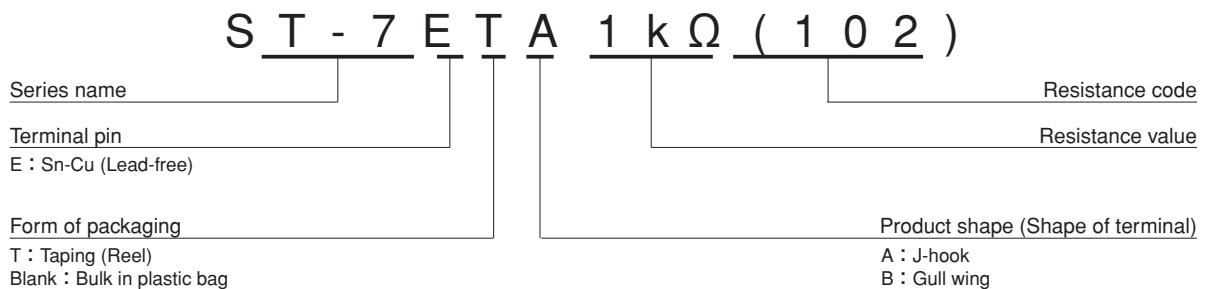

※ Please refer to the LIST OF PART NUMBERS when placing orders.

# ST-7

## SURFACE MOUNT TRIMMERS

### LIST OF PART NUMBERS

Adjustment position	Shape of terminal	Form of packaging	
		Taping (reel)	Plastic bag
Top adjustment	A ( J-hook )	ST-7ETA	ST-7EA
	B ( Gull wing )	ST-7ETB	ST-7EB
Pieces in package		500 pcs./reel	50 pcs./pack

### <Nominal resistance values>

50 Ω	100 Ω	200 Ω	500 Ω	1 k Ω	2 k Ω	5 k Ω
10 k Ω	20 k Ω	50 k Ω	100 k Ω	200 k Ω	500 k Ω	1 M Ω

Fig. 1

- ※ The above part numbers are all available with the respective combination of <Nominal resistance values> (Fig. 1).
- ※ Verify the above part numbers when placing orders.
- ※ Taping specification is not sold separately and must be purchased in reel units.

### ELECTRICAL CHARACTERISTICS

Nominal resistance range	50 Ω ~ 1 M Ω
Resistance tolerance	± 20 %
Power ratings	0.25 W (70 °C) 0 W (125 °C)
Resistance law	Linear law
Maximum input voltage	DC200 V or power rating, whichever is smaller
Maximum wiper current	100 mA or power rating, whichever is smaller
Effective electrical turn	2.5 turns
End resistance	1 % or 2 Ω , whichever is greater
C.R.V.	1 % or 3 Ω , whichever is greater
Operating temp. range	- 55 ~ 125 °C
Temp. coefficient	50 Ω : ± 250 10 <sup>-6</sup> /°C maximum 100 Ω ~ 1 M Ω : ± 100 10 <sup>-6</sup> /°C maximum
Insulation resistance	1000 M Ω minimum (DC500 V)
Dielectric strength	AC600 V, 60 s
Net weight	Approx. 0.25 g

### <Reflow profile for soldering heat evaluation>

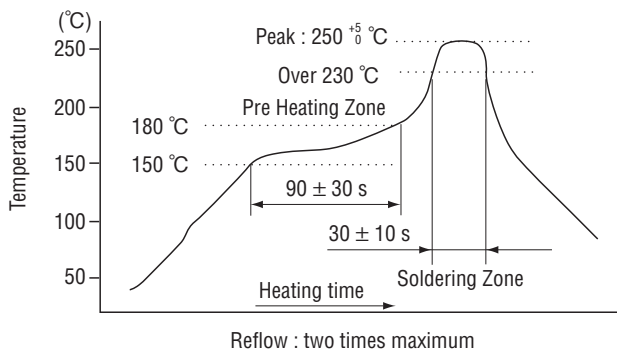

### MECHANICAL CHARACTERISTICS

Mechanical turn	3 turns
Operating torque	5 mN·m {51 gf·cm} maximum
Mechanical stop	Clutch action
Rotational life	100 cycles [ Δ R/R ≤ ± (2 Ω + 3 %)]
Thrust to shaft	5 N {0.51 kgf} minimum
Solderability	245 ± 3 °C, 2 ~ 3 s
Shear (Adhesion)	5 N {0.51 kgf} 10 s
Substrate bending	Width 90 mm, bend 3 mm, 5 s, 1 time
Pull-off strength	5 N {0.51 kgf} 10 s

{ } : Reference only

### ENVIRONMENTAL CHARACTERISTICS

Test item	Test conditions	Specifications
Thermal shock	- 65 ~ 125 °C (0.5 h), 5 cycles	[ Δ R/R ≤ 2 %] [S.S. ≤ 1 %]
Humidity	- 10 ~ 65 °C (80 ~ 98 %), 10 cycles, 240 h	[ Δ R/R ≤ 2 %]
Shock	981 m/s <sup>2</sup> , 6 ms 6 directions for 3 times each	[ Δ R/R ≤ 1 %] [S.S. ≤ 1 %]
Vibration	(Amplitude) 1.52 mm or (Acceleration) 196 m/s <sup>2</sup> , 10 ~ 2000 Hz, 3 directions, 12 times each	
Load life	70 °C, 0.25 W, 1000 h	[ Δ R/R ≤ 3 %] [S.S. ≤ 1 %]
Low temp. operation	- 55 °C, 2 h	[ Δ R/R ≤ 2 %] [S.S. ≤ 2 %]
High temp. exposure	125 °C, 250 h	[ Δ R/R ≤ 3 %] [S.S. ≤ 2 %]
Immersion seal	85 °C, 60 s	No leaks (No continuous bubbles)
Soldering heat	Flow : 260 ± 3 °C as the temperature in a pot of molten solder, immersion from head of terminal to backside of board, 5 ~ 6 s, two times maximum Reflow : Peak temperature 255 °C (Please refer to the profile below.) 手はんだ Manual soldering: 350 ± 10 °C, 3 ~ 4 s	[ Δ R/R ≤ 1 %]

Δ R/R : Change in total resistance  
S.S. : Setting stability



# ST-7

## SURFACE MOUNT TRIMMERS

### PACKAGING SPECIFICATIONS

#### <Taping packaging specifications>

- Taping version is packaged in 500 pcs. per reel.  
Orders will be accepted for units of 500 pcs., i.e., 500, 1000, 1500 pcs., etc.
- Taping version is boxed with one reel (500 pcs.).

Maximum number of consecutive missing pieces = 2  
Leader length and reel dimension are shown in the diagrams below.

### EMBOSED TAPE DIMENSIONS

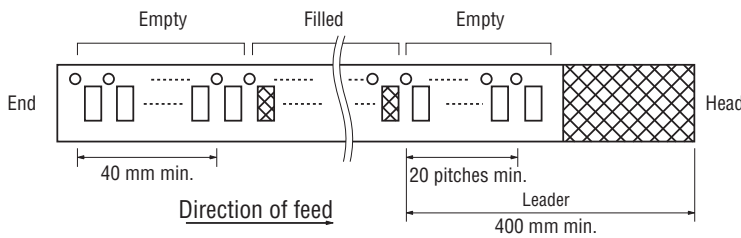

### REEL DIMENSIONS

(Conforms to JIS C 0806-3)  
(In accordance with EIAJ ET-7200A)

(Unit: mm)

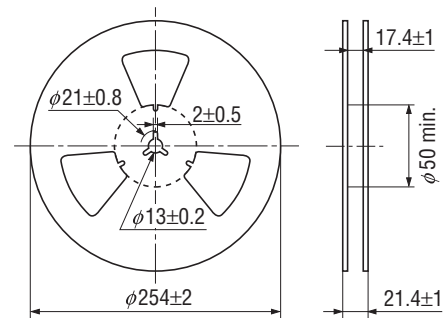

### ST-7ETA

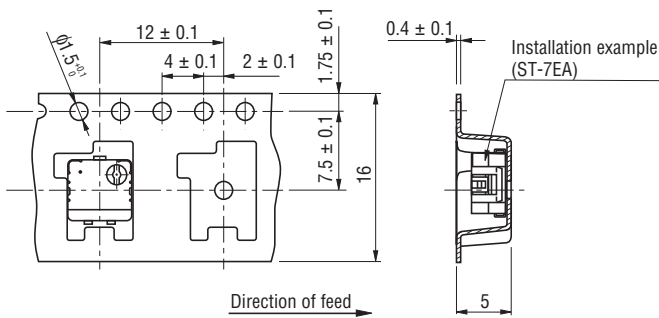

### ST-7ETB

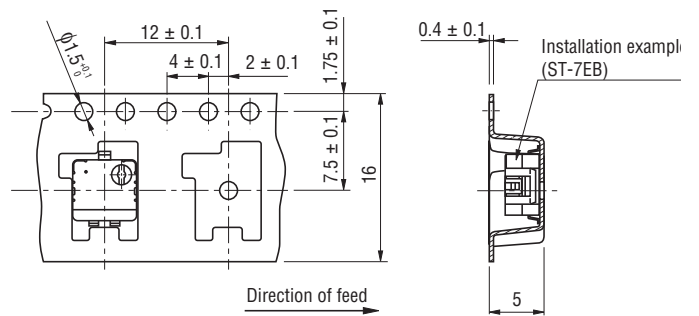

#### <Bulk pack packaging specifications>

- Unit of bulk in a plastic bag is 50 pcs. per pack.
- Boxing of bulk in a plastic bag is performed with 200 pcs. per box.