

# BMD-301

## Stand-alone Bluetooth low energy modules

### Data sheet



### Abstract

This technical data sheet describes the BMD-301 stand-alone Bluetooth® low energy module. The OEMs can embed their own application on top of the integrated Bluetooth low energy stack using Nordic Semiconductor SDK integrated development environment (IDE).

# Document information

<b>Title</b>	<b>BMD-301</b>	
<b>Subtitle</b>	Stand-alone Bluetooth low energy modules	
<b>Document type</b>	Data sheet	
<b>Document number</b>	UBX-19033351	
<b>Revision and date</b>	R26	22-Jun-2022
<b>Disclosure restriction</b>	C1-Public	

<b>Product status</b>	<b>Corresponding content status</b>	
<b>Functional sample</b>	Draft	For functional testing. Revised and supplementary data will be published later.
<b>In development / Prototype</b>	Objective specification	Target values. Revised and supplementary data will be published later.
<b>Engineering sample</b>	Advance information	Data based on early testing. Revised and supplementary data will be published later.
<b>Initial production</b>	Early production information	Data from product verification. Revised and supplementary data may be published later.
<b>Mass production / End of life</b>	Production information	Document contains the final product specification.

This document applies to the following products:

<b>Product name</b>	<b>Type number</b>	<b>Firmware version</b>	<b>IN/PCN reference</b>	<b>Product status</b>
BMD-301	BMD-301-A-R-00	All	N/A	Mass production
BMD-301	BMD-301-A-R-10	AE	UBX-20007336	Mass production

u-blox or third parties may hold intellectual property rights in the products, names, logos and designs included in this document. Copying, reproduction, modification or disclosure to third parties of this document or any part thereof is only permitted with the express written permission of u-blox.

The information contained herein is provided "as is" and u-blox assumes no liability for its use. No warranty, either express or implied, is given, including but not limited to, with respect to the accuracy, correctness, reliability and fitness for a particular purpose of the information. This document may be revised by u-blox at any time without notice. For the most recent documents, visit [www.u-blox.com](http://www.u-blox.com).

Copyright © u-blox AG.

# Contents

<b>Document information</b> .....	<b>2</b>
<b>Contents</b> .....	<b>3</b>
<b>1 Functional description</b> .....	<b>5</b>
1.1 Features .....	5
1.2 Applications .....	6
1.3 Block diagram .....	6
1.4 Product specifications .....	7
<b>2 Pin definition</b> .....	<b>9</b>
2.1 Pin assignment.....	9
<b>3 Electrical specifications</b> .....	<b>11</b>
3.1 Absolute maximum ratings .....	11
3.2 Operating conditions .....	11
3.3 General purpose I/O .....	11
3.4 Peripheral pin assignments .....	12
3.5 Module reset .....	12
3.6 Debug and programming.....	12
3.7 Clocks .....	12
3.7.1 32.768 kHz crystal (LFXO).....	13
3.7.2 32.768 kHz clock source comparison .....	13
<b>4 Firmware</b> .....	<b>14</b>
4.1 Factory image .....	14
4.1.1 Firmware version “AA” .....	14
4.1.2 Firmware version “AB” .....	14
4.1.3 Firmware version “AC” .....	14
4.1.4 Firmware version “AD” .....	15
4.1.5 Firmware version “AE” .....	15
4.2 Module programming and read-back protection .....	15
4.3 SoftDevices .....	15
4.3.1 S132 .....	16
4.3.2 S212 .....	16
4.3.3 S332 .....	16
4.4 Bluetooth device address .....	16
<b>5 Mechanical specifications</b> .....	<b>17</b>
5.1 Dimensions .....	17
5.2 Recommended PCB land pads .....	17
5.3 Module marking.....	18
5.3.1 Module marking for type number BMD-301-A-R-00.....	18
5.3.2 Module marking for type number BMD-301-A-R-10.....	19
<b>6 RF Design notes</b> .....	<b>20</b>
6.1 Recommended RF layout and ground plane.....	20

6.2	Mechanical enclosure .....	20
6.3	Approved external antennas .....	20
<b>7</b>	<b>BMD-301 evaluation development kit.....</b>	<b>21</b>
<b>8</b>	<b>Qualification and approvals.....</b>	<b>22</b>
8.1	United States (FCC): .....	22
8.1.1	Labeling and user information requirements .....	22
8.1.2	RF exposure .....	22
8.2	Canada (ISED).....	23
8.2.1	Labeling and user information requirements .....	23
8.2.2	RF exposure .....	23
8.3	European Union regulatory compliance .....	24
8.3.1	Radio Equipment Directive (RED) 2014/53/EU .....	24
8.3.2	Labeling and user information requirements .....	24
8.4	Japan (MIC) .....	24
8.5	Australia / New Zealand (RCM) .....	25
8.6	South Korea (KCC) .....	25
8.7	Bluetooth qualification.....	25
<b>9</b>	<b>Environmental.....</b>	<b>26</b>
9.1	RoHS .....	26
9.2	REACH .....	26
9.3	California proposition 65 (P65) .....	26
<b>10</b>	<b>Product handling.....</b>	<b>27</b>
10.1	Packaging .....	27
10.1.1	Reel packaging for type number BMD-301-A-R-00.....	27
10.1.2	Reel packaging for type number BMD-301-A-R-10.....	27
10.1.3	Carrier tape dimensions for type number BMD-301-A-R-00 .....	28
10.1.4	Carrier tape dimensions for type number BMD-301-A-R-10 .....	28
10.2	Carrier tape orientation .....	29
10.3	Moisture sensitivity level.....	29
10.4	Reflow soldering .....	29
10.5	ESD precautions.....	29
<b>11</b>	<b>Ordering information.....</b>	<b>30</b>
<b>12</b>	<b>Life support and other high-risk warnings.....</b>	<b>31</b>
	<b>Related documents .....</b>	<b>32</b>
	<b>Revision history .....</b>	<b>33</b>
	<b>Contact.....</b>	<b>33</b>

# 1 Functional description

The BMD-301 from u-blox is a powerful, highly flexible, ultra-low power Bluetooth Low Energy module based on the nRF52832 SoC from Nordic Semiconductor. With an ARM® Cortex™ M4F CPU, embedded 2.4GHz transceiver, and U.FL connector for an external antenna, the BMD-301 provides a complete RF solution with no additional RF design, allowing faster time to market. Providing full use of the nRF52832's capabilities and peripherals, the BMD-301 can power the most demanding applications, all while simplifying designs and reducing BOM costs. With an internal DC-DC converter and intelligent power control, the BMD-301 provides class-leading power efficiency, enabling ultra-low power sensitive applications. Regulatory pre-approvals reduce the burden to enter the market.

## 1.1 Features

- Based on the Nordic Semiconductor nRF52832 SoC
- Bluetooth 5 2M low energy, Advertising Extensions, CSA #2
- Bluetooth mesh
- Complete RF solution with an integrated DC-DC converter
- Nordic Semiconductor SoftDevice ready
- Over-the-Air (OTA) firmware updates
- No external components required
- ARM® Cortex™-M4F 32-bit processor
- 512 kB embedded flash memory
- 64 kB RAM
- -40 °C to +85 °C Temperature range
- 32 General Purpose I/O Pins
- 12-bit/200 KSPS ADC
- Serial Wire Debug (SWD)
- Three SPI Master/Slave (8 Mbps)
- Two 2-wire Master/Slave (I2C compatible)
- Footprint compatible with BMD-301, BMD-330, BMD-360, and BMD-340 (superset)
- UART (w/ CTS/RTS and DMA)
- I2S audio interface
- Low power comparator
- Temperature sensor
- Random number generator
- 20 channel CPU independent Programmable Peripheral Interconnect (PPI)
- Quadrature Demodulator (QDEC)
- 128-bit AES HW encryption
- 5 x 32 bit, 3 x 24 bit Real Timer Counters (RTC)
- NFC-A tag interface for OOB pairing
- Dimensions: 14 x 9.8 x 1.9 mm
- USA (FCC): 2AA9B04
- Canada (ISED): 12208A-04
- Japan (MIC): 210-107153

## 1.2 Applications

- Beacons – iBeacon™, Eddystone, AltBeacon, etc.
- Low power sensors
- Fitness devices
- Wearables
- Climate control
- Lighting
- Safety and security
- Home appliances
- Access control
- Internet of Things
- Home health care
- Advanced remote controls
- Smart energy management
- Low-power sensor networks
- Interactive entertainment
- Key fobs
- Environmental monitoring
- Hotel automation
- Office automation

## 1.3 Block diagram

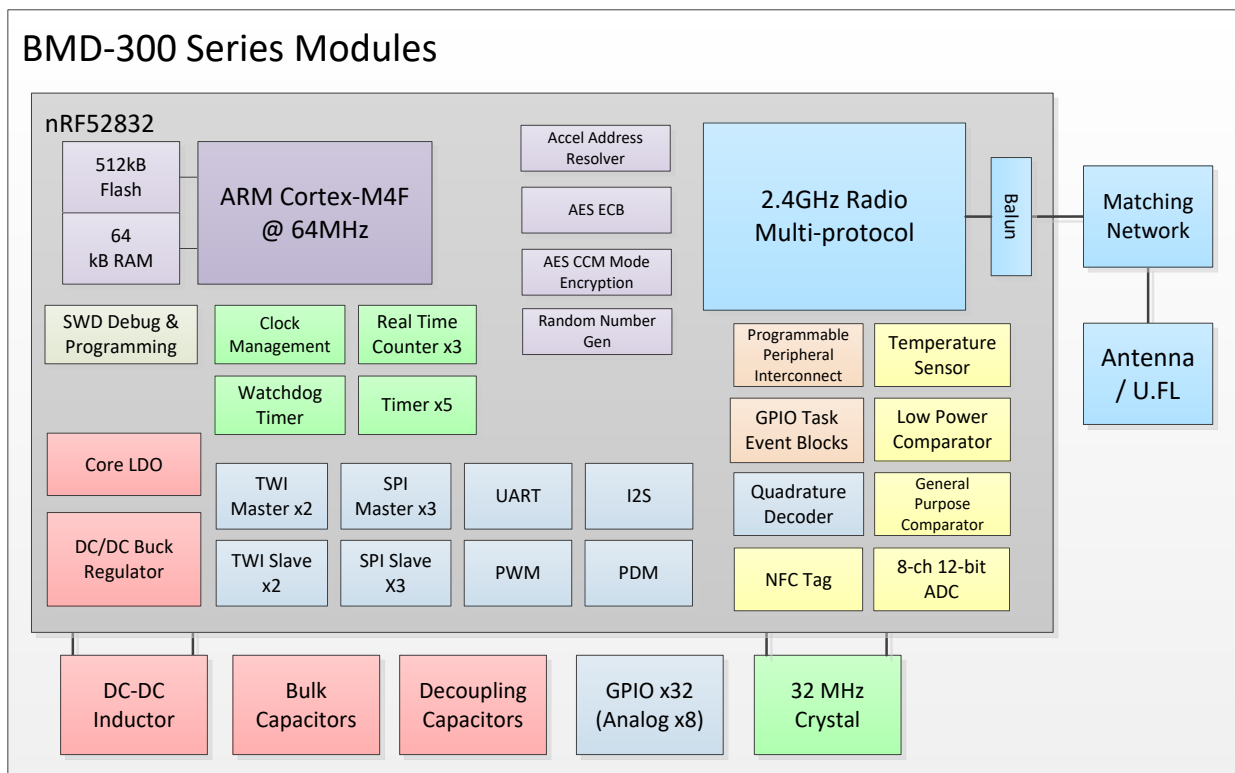

Figure 1: Block diagram of BMD-301

## 1.4 Product specifications

Detail	Description
<b>Bluetooth</b>	
Bluetooth version	Bluetooth 5 low energy, Concurrent Central & Peripheral (S132), 2M LE PHY, 1M LE PHY, Advertising Extensions, CSA #2 Bluetooth mesh
Security	AES-128
LE connections	Concurrent central, observer, peripheral, and broadcaster roles with up to twenty concurrent connections along with one Observer and one Broadcaster (S132)
<b>Radio</b>	
Frequency	2.360 GHz to 2.500 GHz
Modulations	GFSK at 1 Mbps, 2 Mbps data rates
Transmit power	+4 dBm maximum
Receiver sensitivity	-96 dBm (Bluetooth low energy mode)
Antenna	U.FL connector for external antenna
<b>Current consumption</b>	
TX only @ +4 dBm, 0 dBm @ 3V, DCDC enabled	7.5 mA, 5.3 mA
TX only @ +4 dBm, 0 dBm	16.6 mA, 11.6 mA
RX only @ 1 Mbps @ 3V, DCDC enabled	5.4 mA
RX only @ 1 Mbps	11.7 mA
CPU @ 64MHz from flash, from RAM	7.4 mA, 6.7 mA
CPU @ 64MHz from flash, from RAM @ 3V, DCDC	3.7 mA, 3.3 mA
System Off, On	0.3 $\mu$ A, 1.2 $\mu$ A
Additional current for RAM retention	30 nA / 4 KB block
<b>Dimensions</b>	
<b>BMD-301</b>	Length: 14.0 mm $\pm$ 0.3mm
	Width: 9.8 mm $\pm$ 0.3mm
	Height: 1.9 mm $\pm$ 0.1mm
<b>Hardware</b>	
Interfaces	SPI Master/Slave x 3 UART Two-Wire Master/Slave (I2C) x 2 GPIO x 32 I2S PWM PDM
Power supply	1.7 V to 3.6 V
Temperature range	-40 $^{\circ}$ C to +85 $^{\circ}$ C
<b>Certifications</b>	
USA (FCC)	FCC part 15 modular certification FCC ID: 2AA9B04
Canada (ISED)	Industry Canada RSS-210 modular certification ISED: 12208A-04
Europe (CE)	EN 60950-1: A2:2013 3.1 (a): Health and Safety of the User EN 301 489-1 V2.1.1 & 3.1 (b): Electromagnetic Compatibility EN 301 489-17 V3.1.1 EN 300 328 V2.1.1 3.2: Effective use of spectrum allocated
Japan (MIC)	Ministry of Internal Affairs and Communications (MIC) of Japan pursuant to the Radio Act of Japan: MIC: 210-107153

Detail	Description
Australia / New Zealand (RCM)	AS/NZS 4268:2017, Radio equipment and systems – Short range devices
South Korea (KCC)	Certified under Clause 2, Article 58-2 of the Radio Waves Act: R-CRM-Rgd-BMD-300
Bluetooth	BMD-300/301 BT5 RF-PHY Component (Tested) QDID: 101625
<b>Radio chip</b>	
Nordic Semiconductor nRF52832	Additional details: <a href="#">nRF52832 Product Specification</a> <a href="#">Software Development Kit</a>

**Table 1: Product specifications**



## 2 Pin definition

The BMD-300, BMD-301, and BMD-330 share an identical pinout. This pinout is also a subset of the BMD-340 footprint, allowing a single design to support any of these four modules.

### 2.1 Pin assignment

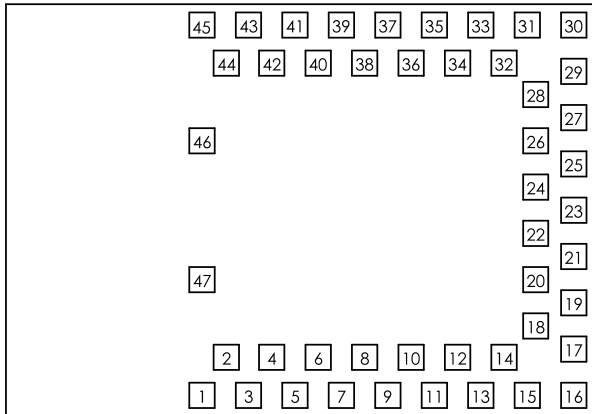

Figure 2: BMD-301 Pin assignment

No.	Name	I/O	Description	nRF52 pin	Remarks
1	GND	Power	Electrical Ground	GND	
2	GND	Power	Electrical Ground	GND	
3	GND	Power	Electrical Ground	GND	
4	GND	Power	Electrical Ground	GND	
5	GND	Power	Electrical Ground	GND	
6	P0.25	I/O	GPIO	P0.25	Use as low drive, low frequency GPIO only Add 12 pF capacitance to ground. See Nordic Semiconductor errata 138 [5]
7	P0.26	I/O	GPIO	P0.26	Use as low drive, low frequency GPIO only Add 12 pF capacitance to ground. See Nordic Semiconductor errata 138 [5]
8	P0.27	I/O	GPIO	P0.27	Use as low drive, low frequency GPIO only
9	P0.28	I/O	GPIO/AIN4	P0.28	Pin is analog capable, use as low drive, low frequency GPIO only
10	P0.29	I/O	GPIO/AIN5	P0.29	Pin is analog capable, use as low drive, low frequency GPIO only
11	P0.30	I/O	GPIO/AIN6	P0.30	Pin is analog capable, use as low drive, low frequency GPIO only
12	P0.31	I/O	GPIO/AIN7	P0.31	Pin is analog capable, use as low drive, low frequency GPIO only
13	P0.00	I/O	GPIO/XTAL1 (32.768 kHz)	P0.00	
14	P0.01	I/O	GPIO/XTAL2 (32.768 kHz)	P0.01	
15	P0.02	I/O	GPIO/AIN0	P0.02	Pin is analog capable
16	GND	Power	Electrical Ground	GND	
17	VCC	Power	+1.7 V to +3.6 V	VCC	An internal 4.7 $\mu$ F bulk capacitor is included on the module. However, it is good design practice to add additional bulk capacitance as required for your application, i.e., those with heavy GPIO usage and/or current draw.
18	GND	Power	Electrical Ground	GND	

No.	Name	I/O	Description	nRF52 pin	Remarks
19	P0.03	I/O	GPIO/AIN1	P0.03	Pin is analog capable
20	P0.04	I/O	GPIO/AIN2	P0.04	Pin is analog capable
21	P0.05	I/O	GPIO/AIN3	P0.05	Pin is analog capable
22	P0.06	I/O	GPIO	P0.06	
23	P0.07	I/O	GPIO	P0.07	
24	P0.08	I/O	GPIO	P0.08	
25	P0.09	I/O	GPIO/NFC1	P0.09	NFC pin 1 (default)
26	P0.10	I/O	GPIO/NFC2	P0.10	NFC pin 2 (default)
27	P0.11	I/O	GPIO	P0.11	
28	P0.12	I/O	GPIO	P0.12	
29	GND	Power	Electrical Ground	GND	
30	GND	Power	Electrical Ground	GND	
31	P0.13	I/O	GPIO	P0.13	
32	P0.14	I/O	GPIO/TRACEDATA[3]	P0.14	
33	P0.15	I/O	GPIO/TRACEDATA[2]	P0.15	
34	P0.16	I/O	GPIO/TRACEDATA[1]	P0.16	
35	P0.17	I/O	GPIO	P0.17	
36	P0.18	I/O	GPIO/TRACEDATA[0]/SWO	P0.18	
37	P0.19	I/O	GPIO	P0.19	
38	P0.20	I/O	GPIO/TRACECLK	P0.20	
39	P0.21	I/O	GPIO/RESET_N	P0.21	May be used as active low reset input
40	P0.22	I/O	GPIO	P0.22	Use as low drive, low frequency GPIO only
41	P0.23	I/O	GPIO	P0.23	Use as low drive, low frequency GPIO only
42	P0.24	I/O	GPIO	P0.24	Use as low drive, low frequency GPIO only
43	SWCLK	I	SWD Clock	SWCLK	
44	SWDIO	I/O	SWD IO	SWDIO	
45	GND	Power	Electrical Ground	GND	
46	GND	Power	Electrical Ground	GND	
47	GND	Power	Electrical Ground	GND	

**Table 2: BMD-301 pinout**

## 3 Electrical specifications

Stressing the device above one or more of the [Absolute maximum ratings](#) may cause permanent damage. These are stress ratings only. Operating the module at these or at any conditions other than those specified in the [Operating conditions](#) should be avoided. Exposure to absolute maximum rating conditions for extended periods may affect device reliability.

All given application information is only advisory and does not form part of the specification.

### 3.1 Absolute maximum ratings

Symbol	Description	Min	Max	Unit
$V_{CC\_MAX}$	Voltage on supply pin	-0.3	3.9	V
$V_{IO\_MAX}$	Voltage on GPIO pins ( $V_{CC} > 3.6$ V)	-0.3	3.9	V
$V_{IO\_MAX}$	Voltage on GPIO pins ( $V_{CC} \leq 3.6$ V)	-0.3	$V_{CC} + 0.3$ V	V
$T_S$	Storage Temperature Range	-40	125	°C

**Table 3: Absolute maximum ratings**

The product is not protected against overvoltage or reversed voltages. If necessary, voltage spikes exceeding the power supply voltage specification, given in table above, must be limited to values within the specified boundaries by using appropriate protection devices.

### 3.2 Operating conditions

Unless otherwise specified, all operating condition specifications are at an ambient temperature of 25 °C and a supply voltage of 3.0 V.

Operation beyond the specified operating conditions is not recommended and extended exposure beyond them may affect device reliability.

Symbol	Parameter	Min	Typ.	Max	Unit
$V_{CC}$	Operating supply voltage	1.7	3.0	3.6	V
$T_{R\_VCC}$	Supply rise time (0 V to 1.7 V)	-	-	60	ms
$T_A$	Operating ambient temperature range	-40	25	85	°C

**Table 4: Operating conditions**

### 3.3 General purpose I/O

The general purpose I/O is organized as one port enabling access and control of the 32 available GPIO pins via one port. Each GPIO can be accessed with the following user configurable features:

- Input/output direction
- Output drive strength
- Internal pull-up and pull-down resistors
- Wake-up from high- or low-level triggers on all pins
- Trigger interrupt on all pins
- All pins can be used by the PPI task/event system; the maximum number of pins that can be interfaced through the PPI at the same time is limited by the number of GPIOTE channels
- All pins can be individually configured to carry serial interface or quadrature demodulator signals

Symbol	Parameter	Min	Typ.	Max	Unit
V <sub>IH</sub>	Input high voltage	0.7 x VCC	-	VCC	V
V <sub>IL</sub>	Input low voltage	VSS	-	0.3 x VCC	V
V <sub>OH</sub>	Output high voltage	VCC - 0.4	-	VCC	V
V <sub>OL</sub>	Output low voltage	VSS	-	VSS + 0.4	V
R <sub>PU</sub>	Pull-up resistance	11	13	16	kΩ
R <sub>PD</sub>	Pull-down resistance	11	13	16	kΩ

**Table 5: GPIO**

### 3.4 Peripheral pin assignments

The various peripherals within the BMD-301 may be assigned to nearly any of the GPIO pins through the application. There are some restrictions called out by the nRF52832 product specification. See Note 2 in [Table 5](#). Also note that certain peripherals are assigned to particular pins, such as the analog inputs and NFC antenna.

### 3.5 Module reset

GPIO pin P0.21 may be used for a hardware reset. In order to utilize P0.21 as a hardware reset, the UICR registers PSELRESET[0] and PSELRESET[1] must be set alike, to the value of 0x7FFFFFFF15. When P0.21 is programmed as RESET, the internal pull-up is automatically enabled. Nordic Semiconductor example applications and development kits program P0.21 as RESET\_N.

### 3.6 Debug and programming

The BMD-301 supports the two pin Serial Wire Debug (SWD) interface and offers flexible and powerful mechanism for non-intrusive debugging of program code. Breakpoints, single stepping, and instruction trace capture of code execution flow are part of this support.

The BMD-301 also supports ETM and ITM trace. Trace data from the ETM and the ITM is sent to an external debugger via a 4-bit wide parallel trace port. In addition to parallel trace, the TPIU supports serial trace via the Serial Wire Output (SWO) trace protocol.

### 3.7 Clocks

The BMD-301 requires two clocks, a high frequency clock and a low frequency clock.

The high frequency clock is provided on-module by a high-accuracy 32 MHz crystal as required by the nRF52832 for radio operation.

The low frequency clock can be provided internally by an RC oscillator or synthesized from the fast clock, or externally by a 32.768 kHz crystal. An external crystal provides the lowest power consumption and greatest accuracy. Using the internal RC oscillator with calibration provides acceptable performance for Bluetooth low energy applications at a reduced cost and slight increase in power consumption.

 The ANT protocol requires the use of an external crystal.

### 3.7.1 32.768 kHz crystal (LFXO)

Symbol	Parameter	Typ.	Max.	Unit
$F_{NOM\_LFXO}$	Crystal frequency	32.768	-	kHz
$F_{TOL\_LFXO\_BLE}$	Frequency tolerance, Bluetooth low energy applications <sup>1</sup>	-	±250	ppm
$f_{TOL\_LFXO\_ANT}$	Frequency Tolerance, ANT applications <sup>1</sup>	-	±50	ppm
$C_{L\_LFXO}$	Load capacitance	-	12.5	pF
$C_{0\_LFXO}$	Shunt capacitance	-	2	pF
$R_{S\_LFXO}$	Equivalent series resistance	-	100	kΩ
$C_{pin}$	Input capacitance on XL1 and XL2 pads	4	-	pF

1:  $f_{TOL\_LFXO\_BLE}$  and  $f_{TOL\_LFXO\_ANT}$  are the maximum allowed for Bluetooth low energy and ANT applications. Actual tolerance depends on the crystal used.

**Table 6: 32.768 kHz crystal (LFXO)**

### 3.7.2 32.768 kHz clock source comparison

Symbol	Parameter	Min.	Typ.	Max.	Unit
$I_{LFXO}$	Current for 32.768 kHz Crystal oscillator	-	0.25	-	μA
$I_{LFRC}$	Current for 32.768 kHz RC oscillator	-	0.6	1	μA
$I_{LFSYNT}$	Current for 32.768 kHz Synthesized oscillator	-	100	-	μA
$f_{TOL\_LFXO\_BLE}$	Frequency Tolerance, 32.768 kHz Crystal oscillator (Bluetooth low energy Stack) <sup>1</sup>	-	-	±250	ppm
$f_{TOL\_LFXO\_ANT}$	Frequency Tolerance, 32.768 kHz Crystal oscillator (ANT Stack) <sup>1</sup>	-	-	±50	ppm
$f_{TOL\_LFRC}$	Frequency Tolerance, 32.768 kHz RC oscillator	-	-	±2	%
$f_{TOL\_CAL\_LFRC}$	Frequency tolerance, 32.768 kHz RC after calibration	-	-	±250	ppm
$f_{TOL\_LFSYNT}$	Frequency Tolerance, 32.768 kHz Synthesized oscillator	-	-	±48	ppm

$f_{TOL\_LFXO\_BLE}$  and  $f_{TOL\_LFXO\_ANT}$  are the maximum allowed for Bluetooth low energy and ANT applications. Actual tolerance depends on the crystal used.

**Table 7: 32.768 kHz clock source comparison**

<sup>1</sup>  $f_{TOL\_LFXO\_BLE}$  and  $f_{TOL\_LFXO\_ANT}$  are the maximum allowed for Bluetooth low energy and ANT applications. Actual tolerance depends on the crystal used

## 4 Firmware

u-blox recommends that projects for the BMD-301 utilize [Nordic Semiconductor's SDK, DFU, and examples](#) and the nRF52832 tools for any new development. This will allow access to the very latest Bluetooth support from Nordic Semiconductor and provide an ongoing path as new features are released.

 For legacy applications, source code is provided through our GitHub repositories for RigDFU, BMDware, Rigablue, developer tools, and mobile apps for customers to customize and extend on their own.

### 4.1 Factory image

The factory programmed firmware version is indicated on the label. Programming of the factory image is maintained solely for legacy applications. New development should use the latest [Nordic Semiconductor SDK and examples](#).

#### 4.1.1 Firmware version “AA”

- RigDFU v3.2.0 (42)
- Nordic Semiconductor S132 SoftDevice v2.0.0
- BMDware v3.1.0 (50)
- Read-back protection enabled.

Modules can be programmed with customer code after a full-chip erase via the SWD interface.

 A full-chip erase will clear the assigned Public MAC address from memory. With Firmware Version AA and AB, the MAC address must be manually recovered.

#### 4.1.2 Firmware version “AB”

- RigDFU v3.2.1 (43)
- Nordic Semiconductor S132 SoftDevice v2.0.0
- BMDware v3.1.1 (51)
- Read-back protection *enabled*.

Modules can be programmed with customer code after a full-chip erase via the SWD interface.

 A full-chip erase will clear the assigned Public MAC address from memory. With Firmware Version AA and AB, the MAC address must be manually recovered.

#### 4.1.3 Firmware version “AC”

- RigDFU v3.2.2 (44)
- Nordic Semiconductor S132 SoftDevice v2.0.0
- BMDware v3.1.1 (51)
- Read-back protection *disabled*.

Modules can be programmed with customer code after a full-chip erase via the SWD interface.

 A full chip erase will clear the assigned Public MAC address from memory; see also [Bluetooth device address](#) on how to retain it.

#### 4.1.4 Firmware version “AD”

- RigDFU v3.3.1 (46)
- Nordic Semiconductor S132 SoftDevice v3.1.0
- BMDware v3.2.1 (60)
- Read-back protection *disabled*.

Modules can be programmed with customer code after a full-chip erase via the SWD interface.

 A full chip erase will clear the assigned Public MAC address from memory; see also [Bluetooth device address](#), “MAC Address Information”, on how to retain it.

#### 4.1.5 Firmware version “AE”

- RigDFU v3.4.0 (47)
- Nordic Semiconductor S132 SoftDevice v3.1.0
- BMDware v3.2.1 (60)
- Read-back protection *disabled*.

Modules can be programmed with customer code after a full-chip erase via the SWD interface.

 A full chip erase will clear the assigned Public MAC address from memory; see also [Bluetooth device address](#), “MAC Address Information”, on how to retain it.

 “AE” marked modules *may not* be loaded with previous factory firmware versions due to Nordic Semiconductor nRF52832 Errata #108. “AA” through “AD” marked modules may be loaded with any Factory Firmware version, including “AE”.

 Type number BMD-301-A-R-10 is loaded with firmware version “AE” only.

## 4.2 Module programming and read-back protection

For legacy applications, RigDFU allows for UART and OTA updates to RigDFU, the SoftDevice and application firmware.

In order to utilize the SWD port on “AA” and “AB” marked modules, the nRF52832 must be erased and recovered. Without this step, the module will not be recognized by most programmers. This is accomplished through *nrfjprog*, which is provided with the Nordic Semiconductor command line utilities:

```
nrfjprog -f nrf52 --recover
```

 A full chip erase is performed, so all components will need to be re-loaded (bootloader, SoftDevice, application firmware, and if used the public Bluetooth device address).

The BMD-301 module may be restored to the factory firmware versions noted above with the utilities available at our GitHub repositories.

## 4.3 SoftDevices

Nordic Semiconductor protocol stacks are known as SoftDevices. SoftDevices are pre-compiled, pre-linked binary files. SoftDevices can be programmed in nRF52 series SoCs and are downloadable from the Nordic Semiconductor website. The BMD-301 with the nRF52832 SoC supports the S132 (Bluetooth low energy Central & Peripheral), S212 (ANT) and S312 (ANT and Bluetooth low energy) SoftDevices.

### 4.3.1 S132

The S132 SoftDevice is a Bluetooth® low energy Central and Peripheral protocol stack solution supporting up to twenty connections with an additional Observer and a Broadcaster role all running concurrently. The S132 SoftDevice integrates a Bluetooth low energy Controller and Host and provides a full and flexible API for building Bluetooth Smart nRF52 System on Chip (SoC) solutions.

### 4.3.2 S212

The S212 SoftDevice is an ANT™ protocol stack solution that provides a full and flexible Application Programming Interface (API) for building ANT System on Chip (SoC) solutions for the nRF52832 chip. The S212 SoftDevice simplifies combining the ANT protocol stack and an application on the same CPU. See the [ANT+ website](#) for membership in the ANT+ Alliance and S212 licensing.

### 4.3.3 S332

The S332 SoftDevice is a combined ANT and Bluetooth low energy protocol stack solution. It supports all four Bluetooth low energy roles (central, peripheral, observer, broadcaster) and ANT.

The S332 SoftDevice provides a full and flexible Application Programming Interface (API) for building concurrent ANT and Bluetooth low energy System on Chip (SoC) solutions. It simplifies combining an ANT and Bluetooth low energy protocol stack and an application on the same CPU, therefore eliminating the need for an added device to support concurrent multiprotocol. See the [ANT+ website](#) for membership in the ANT+ Alliance and S332 licensing.

## 4.4 Bluetooth device address

The BMD-350 module is preprogrammed from the factory with a unique public Bluetooth device (MAC) address stored in the CUSTOMER[0] and CUSTOMER[1] registers of the User Information Configuration Registers (UICR). The Bluetooth device address consists of the IEEE Organizationally Unique Identifier (OUI) combined with the six hexadecimal digits that are printed on a 2D barcode and in human-readable text on the module label, as described in [Module marking](#). The Bluetooth device address is stored in little endian format. The most significant bytes of the CUSTOMER[1] register are 0xFF to complete the 32-bit register.

UICR Register	Address	Description	Remarks
CUSTOMER[0]	0x10001080	Bluetooth_addr [0] (0xFF)	Example value. Actual value printed on label
CUSTOMER[0]	0x10001081	Bluetooth_addr [1] (0xEE)	Example value. Actual value printed on label
CUSTOMER[0]	0x10001082	Bluetooth_addr [2] (0xDD)	Example value. Actual value printed on label
CUSTOMER[0]	0x10001083	Bluetooth_addr [3] (0xCC)	IEEE OUI <sup>2,3</sup>
CUSTOMER[1]	0x10001084	Bluetooth_addr [4] (0xBB)	IEEE OUI <sup>1,2</sup>
CUSTOMER[1]	0x10001085	Bluetooth_addr [5] (0xAA)	IEEE OUI <sup>1,2</sup>
CUSTOMER[1]	0x10001086	0xFF	Unused
CUSTOMER[1]	0x10001087	0xFF	Unused

**Table 8: Bluetooth device address**

<sup>2</sup> The IEEE OUI for type number BMD-301-A-R-00 is: 94:54:93. The full Bluetooth device address is stored in the UICR.

<sup>3</sup> Type number BMD-301-A-R-10 encodes the full Bluetooth device address in the label data matrix and is stored in the UICR.



# 5 Mechanical specifications

## 5.1 Dimensions

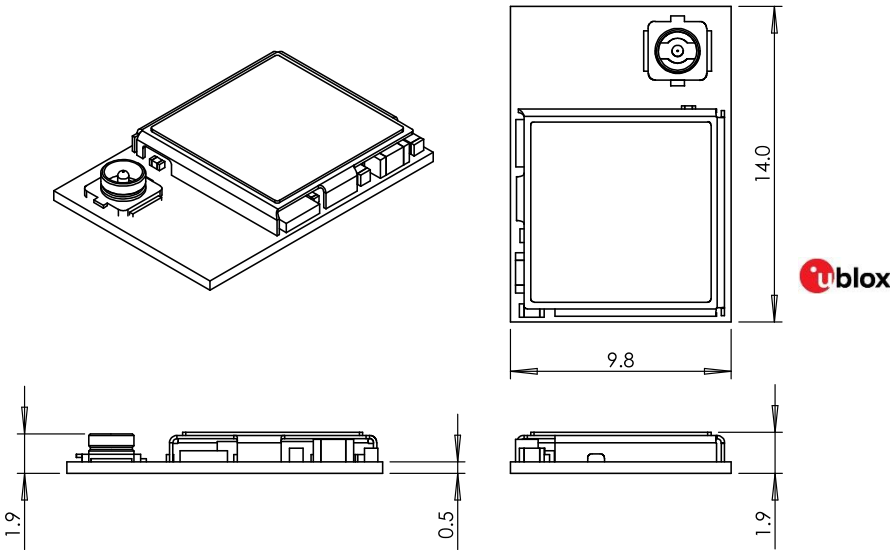

Length:  $\pm 0.3$  mm, Width:  $\pm 0.3$  mm, Height:  $\pm 0.1$  mm

Figure 3: BMD-301 mechanical drawing

## 5.2 Recommended PCB land pads

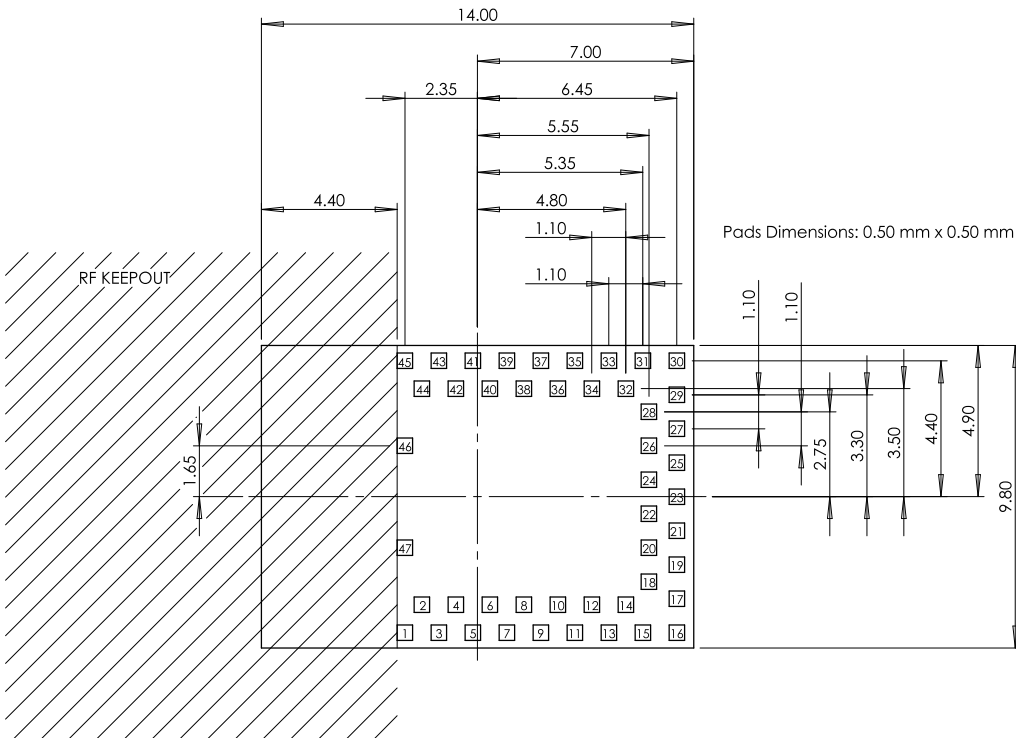

Figure 4: Recommended PCB Land Pads

There is no RF Keep-out area for BMD-301.

### 5.3 Module marking

#### 5.3.1 Module marking for type number BMD-301-A-R-00

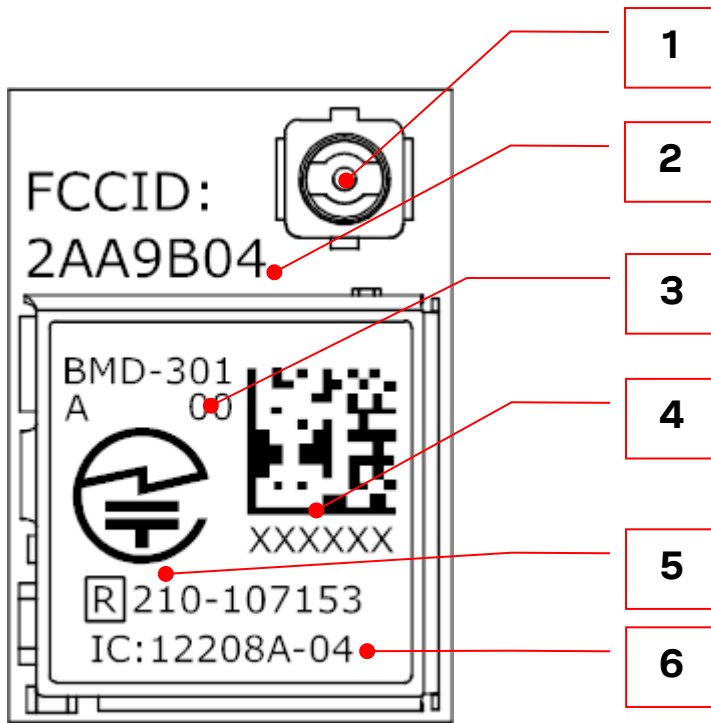

Figure 5: Module marking for type number BMD-301-A-R-00

Reference	Description
1	U.FL connector
2	FCC ID (USA)
3	Firmware version (AA, AB, AC, AD, or AE)
4	Data Matrix (QR code) with unique serial number of six alphanumeric symbols, also in human-readable form. The full Bluetooth address consists of the IEEE OUI (94:54:93) with the six symbols appended: Example value: 94:54:93:XX:YY:ZZ
5	MIC ID and Giteki mark (Japan)
6	ISED ID (Canada)

Table 9: Module marking for type number BMD-301-A-R-00

### 5.3.2 Module marking for type number BMD-301-A-R-10

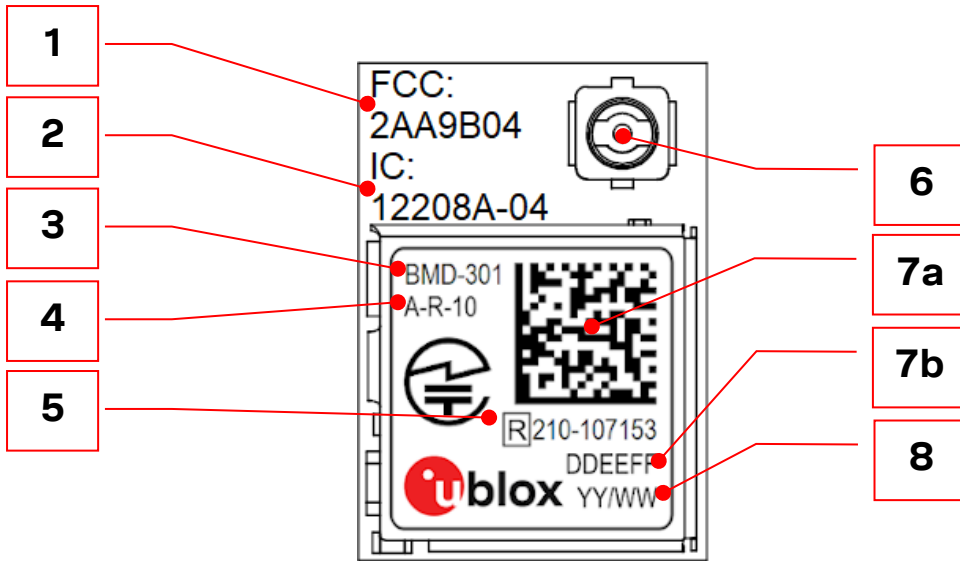

Figure 6: Module marking for type number BMD-301-A-R-10

Reference	Description
1	FCC ID (USA)
2	ISED ID (Canada)
3	Product name
4	Type number (last characters)
5	MIC (Japan) Giteki mark and Certification ID
6	U.FL connector
7a	Data Matrix with unique serial number of 19 alphanumeric symbols. The first 3 symbols represent module type number unique to each module variant, the next 12 symbols represent the unique hexadecimal Bluetooth device address of the module AABCCDDEEFF, and the last 4 symbols represent the hardware and firmware version encoded HFFF. Factory firmware version "AE" is encoded as "01" in the data matrix.
7b	Second half of Bluetooth device address in human-readable format (DDEEFF above)
8	Date of production encoded YY/WW (year / week)

Table 10: Module marking

## 6 RF Design notes

### 6.1 Recommended RF layout and ground plane

Since the BMD-301 relies on an external antenna, there are no ground plane requirements or keep-out area for the module itself. Refer to the external antenna datasheet for antenna placement and grounding recommendations. For a design that may be also populated with a BMD-3 module with an on-board antenna, follow the RF layout and ground plane recommendations for that module.

### 6.2 Mechanical enclosure

For the BMD-301, refer to the external antenna datasheet for placement in or on a mechanical enclosure.

### 6.3 Approved external antennas

The antennas listed below were tested for use with the BMD-301.

#	Mfg.	Part Number	Max. Gain	Type	Size	Approvals
1	Pulse	W1030	2 dBi	1/4 Wave Dipole – Whip	Length: 108.3mm	FCC, IC, MIC, CE, RCM
2	Taoglas	FXP73.07.0100A	2.5dBi	1/4 Wave Dipole – Flex	7mm x 47mm x 0.1mm	FCC, IC, MIC, CE, RCM
3	Pulse	W1027	3.2 dBi	1/4 Wave Dipole – Whip	Length: 136.8mm	FCC, IC, MIC, CE, RCM
4	Kinsun	6670113050-145	2.0 dBi	1/4 Wave Dipole – PCB	12mm x 65mm x 0.46mm	FCC, IC, MIC, CE, RCM
5	Kinsun	6610103081	5.0 dBi	1/2 Wave Dipole – Whip	Length: 196.6mm	FCC, IC, MIC, CE, RCM

**Table 11 – Approved external antennas**

## 7 BMD-301 evaluation development kit



The BMD-301-EVAL is a full featured evaluation board that provides a complete I/O pin out to headers, on-board programming and debugging, 32.768 kHz crystal, power and virtual COM port over USB, four user LEDs, and four user buttons. The kit also includes two external 2.4 GHz antennas. The evaluation boards also provide the option to be powered from a CR2032 coin cell battery and have current sense resistors and headers to allow for convenient current measurements. An Arduino Uno R3 style header is provided for easy prototyping of additional functions. The evaluation boards also support programming off-board BMD-3 series, ANNA-B1, and NINA-B1/B3 series modules.

## 8 Qualification and approvals

### 8.1 United States (FCC):

The BMD-301 has received Federal Communications Commission (FCC) CFR47 Telecommunications, Part 15 Subpart C “Intentional Radiators” modular approval in accordance with Part 15.247 Modular Transmitter approval. The modular approval allows the end user to integrate the module into a finished product without obtaining subsequent and separate FCC approvals for intentional radiation, provided no changes or modifications are made to the module circuitry. Changes or modifications could void the user’s authority to operate the equipment. The end user must comply with all of the instructions provided by the Grantee, which indicate installation and/or operating conditions necessary for compliance.

The finished product is required to comply with all applicable FCC equipment authorizations regulations, requirements and equipment functions not associated with the transmitter module portion. For example, compliance must be demonstrated to regulations for other transmitter components within the host product; to requirements for unintentional radiators (Part 15 Subpart B “Unintentional Radiators”), such as digital devices, computer peripherals, radio receivers, etc.; and to additional authorization requirements for the non-transmitter functions on the transmitter module (i.e., Verification, or Declaration of Conformity) (e.g., transmitter modules may also contain digital logic functions) as appropriate.

-  Modification to this product will void the users’ authority to operate this equipment.
-  The OEM is still responsible for verifying end product compliance with FCC Part 15, subpart B limits for unintentional radiators through an accredited test facility.

#### 8.1.1 Labeling and user information requirements

**The BMD-301 is assigned the FCC ID number: 2AA9B04**

If the FCC ID is not visible when the module is installed inside another device, then the outside of the finished product into which the module is installed must also display a label referring to the enclosed module. This exterior label can use the following or similar wording:

Contains FCC ID: 2AA9B04

In addition to marking the product with the appropriate FCC ID, the end product user manual may also require specific information based on the digital device classification. Refer to the [FCC Rules, Title 47, Subchapter A, Part 15, Subpart B, Chapter §15.105](#) for specific wording of the notices.

#### 8.1.2 RF exposure

All transmitters regulated by FCC must comply with RF exposure requirements. [KDB 447498 General RF Exposure Guidance](#) provides guidance in determining whether proposed or existing transmitting facilities, operations or devices comply with limits for human exposure to Radio Frequency (RF) fields adopted by the Federal Communications Commission (FCC).

This module is approved for installation into mobile and/or portable host platforms and must not be co-located or operating in conjunction with any other antenna or transmitter except in accordance with FCC multi-transmitter guidelines. End users must be provided with transmitter operating conditions for satisfying RF Exposure compliance.

## 8.2 Canada (ISED)

The BMD-301 module is certified for use in Canada under Innovation, Science and Economic Development Canada (ISED) Radio Standards Specification (RSS) RSS-247 and RSSGen.

### 8.2.1 Labeling and user information requirements

**The BMD-301 is assigned the IC ID number: 12208A-04**

Labeling Requirements for the Host Device (from Section 3.2.1, RSS-Gen, Issue 3, December 2010): The host device shall be properly labeled to identify the module within the host device. The Industry Canada certification label of a module shall be clearly visible at all times when installed in the host device, otherwise the host device must be labeled to display the Industry Canada certification number of the module, preceded by the words “Contains transmitter module”, or the word “Contains”, or similar wording expressing the same meaning, as follows:

Contains transmitter module IC: 12208A-04

User Manual Notice for License-Exempt Radio Apparatus (from Section 7.1.3 RSS-Gen, Issue 3, December 2010): User manuals for license-exempt radio apparatus shall contain the following or equivalent notice in a conspicuous location in the user manual or alternatively on the device or both:

This device complies with Industry Canada license exempt RSS standard(s). Operation is subject to the following two conditions: (1) this device may not cause interference, and (2) this device must accept any interference, including interference that may cause undesired operation of the device.

Le présent appareil est conforme aux CNR d'Industrie Canada applicables aux appareils radio exempts de licence. L'exploitation est autorisée aux deux conditions suivantes: (1) l'appareil ne doit pas produire de brouillage, et (2) l'utilisateur de l'appareil doit accepter tout brouillage radioélectrique subi, même si le brouillage est susceptible d'en compromettre le fonctionnement.

Transmitter Antenna (from Section 7.1.2 RSS-Gen, Issue 3, December 2010): User manuals for transmitters shall display the following notice in a conspicuous location:

Under Industry Canada regulations, this radio transmitter may only operate using an antenna of a type and maximum (or lesser) gain approved for the transmitter by Industry Canada. To reduce potential radio interference to other users, the antenna type and its gain should be so chosen that the equivalent isotropically radiated power (e.i.r.p.) is not more than that necessary for successful communication.

Conformément à la réglementation d'Industrie Canada, le présent émetteur radio peut fonctionner avec une antenne d'un type et d'un gain maximal (ou inférieur) approuvé pour l'émetteur par Industrie Canada. Dans le but de réduire les risques de brouillage radioélectrique à l'intention des autres utilisateurs, il faut choisir le type d'antenne et son gain de sorte que la puissance isotrope rayonnée équivalente (p.i.r.e.) ne dépasse pas l'intensité nécessaire à l'établissement d'une communication satisfaisante.

### 8.2.2 RF exposure

All transmitters regulated by IC must comply with RF exposure requirements listed in RSS-102 - Radio Frequency (RF) Exposure Compliance of Radiocommunication Apparatus (All Frequency Bands). This module is approved for installation into mobile and/or portable host platforms and must not be co-located or operating in conjunction with any other antenna or transmitter except in accordance with Industry Canada's multi-transmitter guidelines. End users must be provided with transmitter operating conditions for satisfying RF Exposure compliance.

## 8.3 European Union regulatory compliance

Information about regulatory compliance of the European Union for the BMD-301 module is available in the BMD-301 Declaration of Conformity.

### 8.3.1 Radio Equipment Directive (RED) 2014/53/EU

The BMD-301 module complies with the essential requirements and other relevant provisions of Radio Equipment Directive (RED) 2014/53/EU.

### 8.3.2 Labeling and user information requirements

The label on the final products which contain the BMD-301 module must follow CE marking requirements. The “R&TTE Compliance Association Technical Guidance Note 01” provides guidance on final product CE marking.

## 8.4 Japan (MIC)

The BMD-301 module has received type certification and is labeled with its own technical conformity mark and certification number as required to conform to the technical standards regulated by the Ministry of Internal Affairs and Communications (MIC) of Japan pursuant to the Radio Act of Japan. Integration of this module into a final end product does not require additional radio certification provided installation instructions are followed and no modifications of the module are allowed. Additional testing may be required:

- If the host product is subject to electrical appliance safety (for example, powered from an AC mains), the host product may require Product Safety Electrical Appliance and Material (PSE) testing. The integrator should contact their conformance laboratory to determine if this testing is required.
- There is a voluntary Electromagnetic Compatibility (EMC) test for the host product administered by VCCI: [http://www.vcci.jp/vcci\\_e/index.html](http://www.vcci.jp/vcci_e/index.html)

The label on the end product which contains a BMD-301 module must follow the MIC marking requirements. Labeling requirements for Japan available at the Ministry of Internal Affairs and Communications (MIC) website: <http://www.tele.soumu.go.jp/e/index.htm>.

The BMD-301 module is labeled with its assigned technical conformity mark and certification number. The end product in which this module is being used must have an external label referring to the type certified module inside:

Contains transmitter module with certificate number:

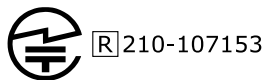



## 8.5 Australia / New Zealand (RCM)

The BMD-301 has been tested to comply with the AS/NZS 4268:2017, Radio equipment and systems – Short range devices – Limits and methods of measurement. The report may be obtained from your local FAE and may be used as evidence in obtaining permission to use the Regulatory Compliance Mark (RCM).

Information on registration as a Responsible Party, license and labeling requirements may be found at the following websites:

Australia: <http://www.acma.gov.au/theACMA/radiocommunications-short-range-devices-standard-2004>

New Zealand: <http://www.rsm.govt.nz/compliance>

Only Australian-based and New Zealand-based companies who are registered may be granted permission to use the RCM. An Australian-based or New Zealand-based agent or importer may also register as a Responsible Party to use the RCM on behalf of a company not in Australia or New Zealand.

## 8.6 South Korea (KCC)

The BMD-301 shares the same certification as BMD-300, and is certified under Clause 2, Article 58-2 of the Radio Waves Act.

When a product containing the BMD-300 is placed on the South Korean market, the product must be affixed with a label or marking containing the KCC logo and certification number as shown in the following figure. This information must also be included in the product user manuals.

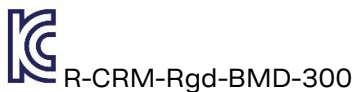

The height of the KCC logo must be at least 5 mm.

## 8.7 Bluetooth qualification

The Bluetooth SIG maintains the Bluetooth Specification and ensures that products are properly tested and comply with the Bluetooth license agreements. Companies that list products with the Bluetooth SIG are required to be members of the SIG and submit the listed fees. Refer to this link for details: <https://www.bluetooth.com/develop-with-bluetooth/qualification-listing>

The BMD-301 Bluetooth Low Energy module based on the Nordic Semiconductor nRF52832 is listed as a “Tested Component”, with Qualified Design ID 101625. This allows an end-product based on a BMD-301 module to inherit the component listings without the need to run through all of the tests again. The end-product will often inherit several QDIDs, and are identified on a “Declaration of Compliance”.

The BMD-301 primarily utilizes the 132 SoftDevice.

## 9 Environmental

### 9.1 RoHS

The BMD-301 is in compliance with Directive 2011/65/EU, 2015/863/EU of the European Parliament and the Council on the restriction of the use of certain hazardous substances in electrical and electronic equipment. The RoHS declaration is available in the BMD-301 EU Declaration of Conformity [2].

### 9.2 REACH

The BMD-301 does not contain the [SVHC \(Substance of Very High Concern\)](#), as defined by Directive EC/1907/2006 Article according to REACH Annex XVII.

### 9.3 California proposition 65 (P65)

This product can expose you to Nickel (metallic), which is known to the State of California to cause cancer. For more information go to [www.P65Warnings.ca.gov](http://www.P65Warnings.ca.gov). Warnings are not required where the listed chemical is inaccessible to the average user of the end product.

## 10 Product handling

### 10.1 Packaging

#### 10.1.1 Reel packaging for type number BMD-301-A-R-00

Modules are packaged on 330 mm reels loaded with 1000 modules. Each reel is placed in an antistatic bag with a desiccant pack and humidity card and placed in a 340x350x65 mm box. An antistatic warning and reel label are adhered to the outside of the bag.

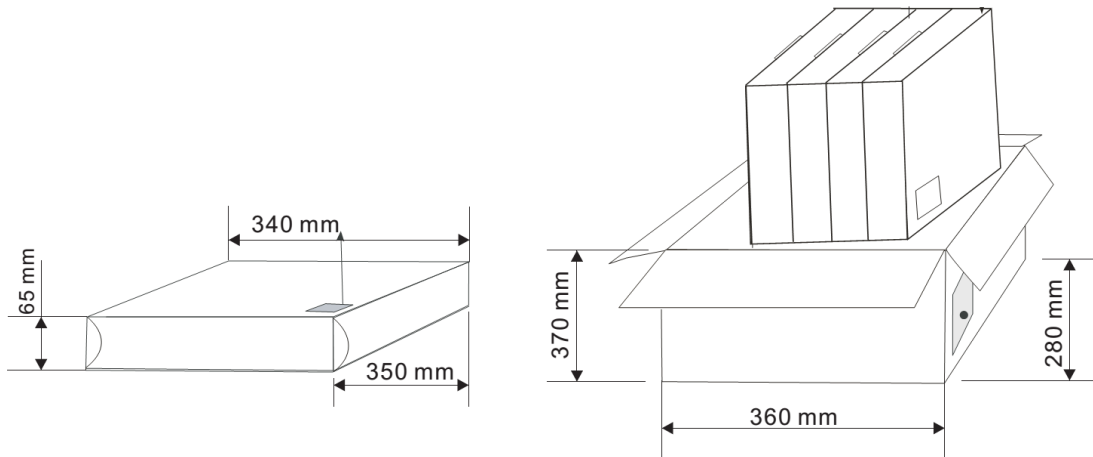

Figure 7: Reel cartons used for type number BMD-301-A-R-10

#### 10.1.2 Reel packaging for type number BMD-301-A-R-10

Modules are packaged on 330 mm reels loaded with 1000 modules. Each reel is placed in an antistatic bag with a desiccant pack and humidity card and placed in a 370x355x56 mm box. See the u-blox Package Information Guide [\[1\]](#) for full specifications on reel dimensions, box sizes and shipping label content. BMD-301-A-R-10 modules use u-blox reel type A3.

### 10.1.3 Carrier tape dimensions for type number BMD-301-A-R-00

The BMD-301-A-R-00 modules are placed in the carrier tape specified in Figure 8. The module antenna connector is facing the tape sprocket holes.

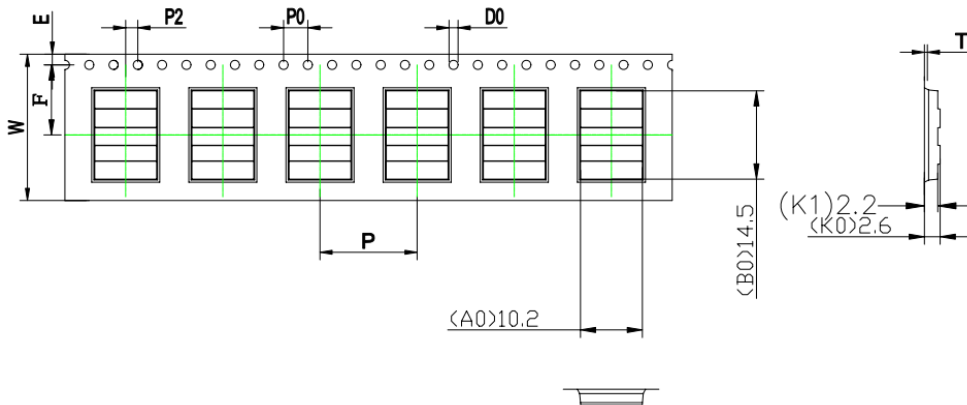

ITEM	W	A <sub>0</sub>	B <sub>0</sub>	K <sub>0</sub>	K <sub>1</sub>	P	F	E	D <sub>0</sub>	D <sub>1</sub>	P <sub>0</sub>	P <sub>2</sub>	T
DIM	24.0 <sup>+0.30</sup> <sub>-0.30</sub>	10.2 <sup>+0.10</sup> <sub>-0.10</sub>	14.5 <sup>+0.10</sup> <sub>-0.10</sub>	2.6 <sup>+0.10</sup> <sub>-0.10</sub>	2.2 <sup>+0.00</sup> <sub>-0.00</sub>	16.0 <sup>+0.10</sup> <sub>-0.10</sub>	11.5 <sup>+0.10</sup> <sub>-0.10</sub>	1.75 <sup>+0.10</sup> <sub>-0.10</sub>	1.50 <sup>+0.10</sup> <sub>-0.00</sub>	0.00 <sup>+0.10</sup> <sub>-0.00</sub>	4.00 <sup>+0.10</sup> <sub>-0.10</sub>	2.00 <sup>+0.10</sup> <sub>-0.10</sub>	0.30 <sup>+0.05</sup> <sub>-0.05</sub>
ALTERNATE													

Figure 8: BMD-301-A-R-00 carrier tape dimensions

### 10.1.4 Carrier tape dimensions for type number BMD-301-A-R-10

The BMD-301-A-R-10 modules are placed in the carrier tape specified in Figure 9. The module antenna connector is facing the tape sprocket holes.

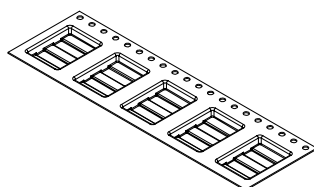
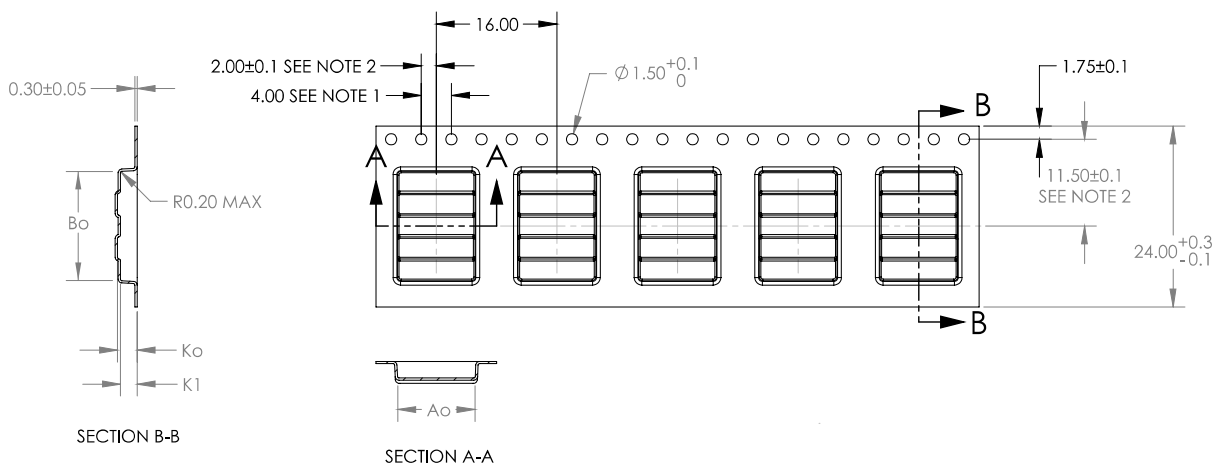

	DIM	±
A <sub>0</sub>	10.30	0.1
B <sub>0</sub>	14.50	0.1
K <sub>0</sub>	2.60	0.1
K <sub>1</sub>	2.20	0.1

NOTES:

1. 10 SPROCKET HOLE PITCH CUMULATIVE TOLERANCE  $\pm 0.2$
2. POCKET POSITION RELATIVE TO SPROCKET HOLE MEASURED AS TRUE POSITION OF POCKET, NOT POCKET HOLE.
3. A<sub>0</sub> AND B<sub>0</sub> ARE MEASURED ON A PLANE AT A DISTANCE "R" ABOVE THE BOTTOM OF THE POCKET.

Figure 9: BMD-301-A-R-10 carrier tape dimensions

## 10.2 Carrier tape orientation

BMD-301 modules are positioned in the carrier tape with the red u-blox logo dot on the label in quadrant 3. See [Figure 10](#).

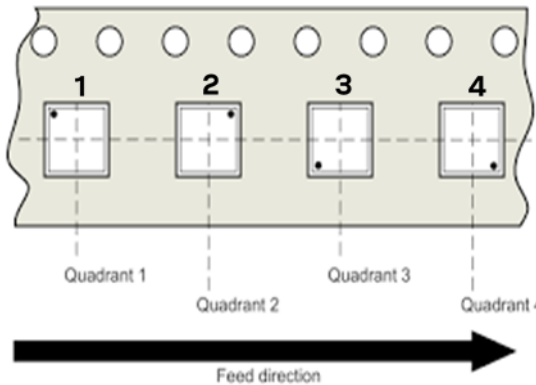

Figure 10: Carrier tape quadrants

“Feed direction” is defined in such a way that at the customer’s assembly line a module is first picked at position “4” and then picked at positions “3”, “2” and “1”.

## 10.3 Moisture sensitivity level

The BMD-301 series is rated for MSL 3, 168-hour floor life after opening.

## 10.4 Reflow soldering

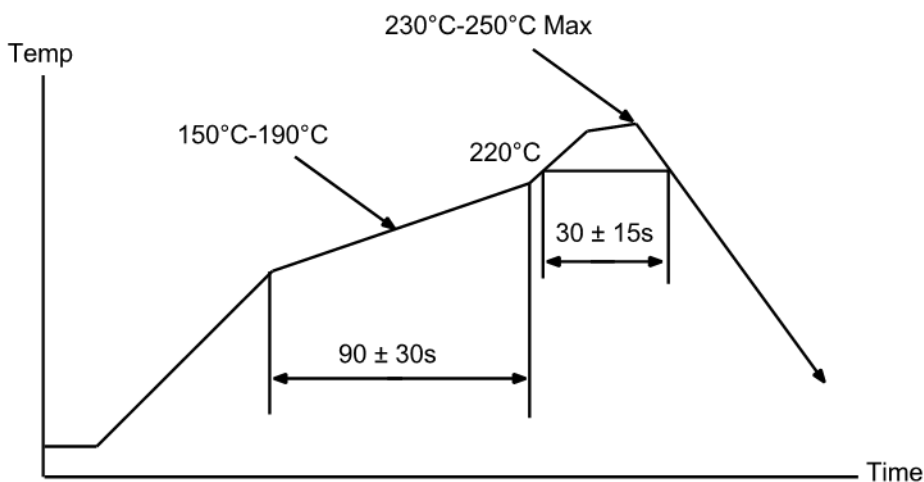

Figure 11: Reflow profile for lead free solder

## 10.5 ESD precautions

⚠ The BMD-301 module contains highly sensitive electronic circuitry and is an Electrostatic Sensitive Device (ESD). Handling the BMD-301 module without proper ESD protection may destroy or damage them permanently.

Proper ESD handling and packaging procedures must be applied throughout the processing, handling and operation of any application that incorporates the BMD-301 module. Failure to observe these recommendations can result in severe damage to the device.

# 11 Ordering information

Ordering Code	Product
BMD-301-A-R	BMD-301 module, Rev A, Tape & Reel, 1000-piece multiples
BMD-301-Eval	BMD-301 Evaluation Kit w/ SEGGER J-Link-OB debug probe and external antennas

**Table 12: Product ordering codes**

## 12 Life support and other high-risk warnings

This product is not designed nor intended for use in a life support device or system, nor for use in other fault-intolerant, hazardous or other environments requiring fail-safe performance, such as any application in which the failure or malfunction of the product could lead directly or indirectly to death, bodily injury, or physical or property damage (collectively, “High-Risk Environments”).

 u-blox expressly disclaims any express or implied warranty of fitness for use in high-risk environments.

The customer using this product in a High-Risk Environment agrees to indemnify and defend u-blox from and against any claims and damages arising out of such use.

## Related documents

- [1] u-blox Package Information Guide, [UBX-14001652](#)
- [2] u-blox BMD-301 EU Declaration of Conformity, [UBX-20002664](#)
- [3] Nordic Semiconductor, [nRF52832 Product Specification](#)
- [4] Nordic Semiconductor, [nRF5 Software Development Kit](#)
- [5] Nordic Semiconductor, [nRF52832 errata 138](#)

 For product change notifications and regular updates of u-blox documentation, register on our website, [www.u-blox.com](http://www.u-blox.com).



# Revision history

Revision	Date	Name	Comments
0.8	06-Nov-2015		Initial preliminary release.
0.8.1	10-Nov-2015		Updated Table 5, Figure 5, Section 7.5. Corrected antenna references.
0.8.2	11-Nov-2015		Updated Figure 1.
0.8.3	20-Nov-2015		Updated current ratings from nRF52832 OPC v0.6.3. Corrected Table 3.
0.9	17-Mar-2016		Added BMD-301, GPIO notes, MSL, updated certifications, updated electrical specifications
0.9.4	23-Mar-2016		Added BMD-301 antennas
1.0	04-May-2016		Production Release; removed pending for FCC, Japan (MIC), & Bluetooth
1.1	20-May-2016		Removed pending for IC, MIC (BMD-301)
1.2	03-Jun-2016		Added Factory Firmware Version AB information
1.3	06-Jun-2016		Updated Module Programming and Read-Back Protection section
1.4	07-Jul-2016		Added preliminary information for the BMD-350
1.5	28-Jul-2016		Added RigDFU and BMDware pin numbers, corrected nRF52832 PS link
1.6	10-Aug-2016		Corrected RESET pin number on BMD-350
1.7	10-Nov-2016		Updated layout drawings, added more BMD-350 data + certs
1.8	02-Dec-2016		Added BMD-350 Japan certificate number
1.9	10-Aug-2017		Added RED for BMD-300, BMD-301, BMD-350; BT DID for BMD-350, Factory Firmware AD
1.10	29-Sep-2017		Added Bluetooth 5 QDIDs, Factory Firmware AE
1.11	17-Apr-2018		Added antenna gain in section 5
1.2	08-Oct-2018		Added BMDware, RigDFU, Rigablue notice in Section 8. Removed BMDware and RigDFU pin-out sections 6.3 and 6.4. Called out BMD-300/301/350 in title rather than "Series"
2.0	01-Feb-2019		Updated to new format BMD-300, BMD-301, and BMD-350 are now in separate datasheets Updated Life Support and other High-Risk Use Warning
2.1	28-Feb-2019		Added Bluetooth mesh to Features and Quick Specifications. Updated links to Nordic Semiconductor web information
R22	10-Jan-2020	brec	Document converted from Rigado BMD-301 data sheet to u-blox BMD-301 data sheet.
R23	13-Feb-2020	brec	Added type number BMD-301-A-R-10; Added u-blox logo to Figure 3 to show orientation of label; Added label information for new type number in section 5.3; Added ESD precautions in section 10.5; Changed images to be u-blox branded; Added packaging specification for type number BMD-301-A-R-10 in section 10.1.
R24	31-Mar-2020	brec	Updated product photo
R25	08-Oct-2021	brec	Added reference to Nordic Semiconductor errata 138 for nRF52832, added South Korea (KCC) certification
R26	22-Jun-2022	brec	Added <a href="#">Carrier tape orientation</a> . Removed ambiguous description of operating condition ranges in <a href="#">Electrical specifications</a> . Revised contact information. Added previously missing footnote in <a href="#">32.768 kHz clock source comparison</a> .

## Contact

For further support and contact information, visit us at [www.u-blox.com/support](http://www.u-blox.com/support).