

Qxx40xx Series

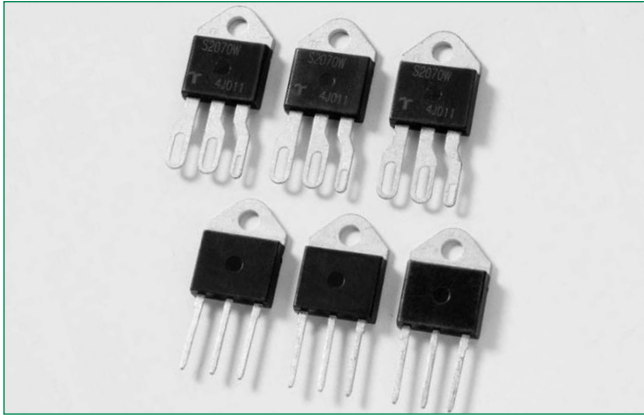

Description

The 40 Amp bi-directional solid state switch series is designed for AC switching and phase control applications such as motor speed, temperature modulation controls, lighting controls, and static switching relays.

Alternistor type components only operate in quadrants I, II, & III and are used in circuits requiring high dv/dt capability.

Standard type devices operate in quadrants I,II,III & IV.

Agency Approval

Agency	Agency File Number
	E71639*

* - K and J Packages

Features & Benefits

- RoHS Compliant
- Glass – passivated junctions
- Voltage capability up to 1000V
- Surge capability up to 400A
- Electrically isolated K & J -Packages are UL Recognized for 2500Vrms

Main Features

Symbol	Value	Unit
$I_{T(RMS)}$	40	A
V_{DRM}/V_{RRM}	400 to 1000	V
$I_{GT(Q1)}$	35 to 100	mA

Applications

Excellent for AC switching and phase control applications such as heating, lighting, and motor speed controls.

Typical applications are AC solid-state switches, industrial power tools, exercise equipment, white goods and commercial appliances.

Alternistor Triacs (no snubber required) are used in applications with extremely inductive loads requiring highest commutation performance.

Internally constructed isolated packages are offered for ease of heat sinking with highest isolation voltage.

Schematic Symbol

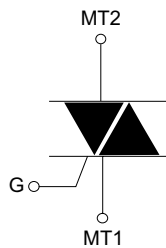

Absolute Maximum Ratings – Alternistor Triac (3 Quadrants)

Symbol	Parameter	Value	Unit
$I_{T(RMS)}$	RMS on-state current (full sine wave)	Qxx40x7 Qxx40xH6 $T_C = 75^\circ\text{C}$	40 A
I_{TSM}	Non repetitive surge peak on-state current (full cycle, T_J initial = 25°C)	$f = 50\text{ Hz}$ $t = 20\text{ ms}$	335 A
		$f = 60\text{ Hz}$ $t = 16.7\text{ ms}$	400 A
I^2t	I^2t Value for fusing	$t_p = 8.3\text{ ms}$	664 A^2s
di/dt	Critical rate of rise of on-state current ($I_G = 2 \times I_{GT}$, $t_r \leq 100\text{ ns}$)	$f = 120\text{ Hz}$ $T_J = 125^\circ\text{C}$	150 $\text{A}/\mu\text{s}$
I_{GTM}	Peak gate trigger current	$t_p = 20\mu\text{s}$ $T_J = 125^\circ\text{C}$	4 A
$P_{G(AV)}$	Average gate power dissipation	$T_J = 125^\circ\text{C}$	0.5 W
T_{stg}	Storage temperature range		-40 to 150 $^\circ\text{C}$
T_J	Operating junction temperature range		-40 to 125 $^\circ\text{C}$

Absolute Maximum Ratings – Standard Triac (4 Quadrants)

Symbol	Parameter	Test Conditions	Value	Unit
$I_{T(RMS)}$	RMS on-state current	Qxx40x3/Qxx40x4 $T_C = 75^\circ\text{C}$	40	A
I_{TSM}	Peak non-repetitive surge current	$f = 50\text{ Hz}$ $t = 20\text{ ms}$	335	A
		$f = 60\text{ Hz}$ $t = 16\text{ ms}$	400	A
I^2t	I^2t Value for fusing	$t_p = 8.3\text{ ms}$	664	A^2s
di/dt	Critical rate-of-rise of on-state current	$f = 120\text{ Hz}; T_J = 125^\circ\text{C}$	150	$\text{A}/\mu\text{s}$
I_{GTM}	Peak gate current	$t_p = 20\mu\text{s}$ $T_J = 125^\circ\text{C}$	4	A
$P_{G(AV)}$	Average gate power dissipation	$T_J = 125^\circ\text{C}$	0.5	W
T_{stg}	Storage temperature range		-40 to 150	$^\circ\text{C}$
T_J	Operating junction temperature range		-40 to 125	$^\circ\text{C}$

Electrical Characteristics ($T_J = 25^\circ\text{C}$, unless otherwise specified) – Alternistor Triac (3 Quadrants)

Symbol	Test Conditions	Quadrant	Value			Unit	
			Qxx40xH6	Qxx40K5	Qxx40x7		
I_{GT}	$V_D = 12\text{ V}$ $R_L = 60\ \Omega$	I – II – III	MAX.	80	50	100	mA
V_{GT}	$V_D = 12\text{ V}$ $R_L = 60\ \Omega$	I – II – III	MAX.	1.3	1.3	2.0	V
V_{GD}	$V_D = V_{DRM}$ $R_L = 3.3\text{ k}\Omega$ $T_J = 125^\circ\text{C}$	I – II – III	MIN.	0.2			V
I_H	$I_T = 400\text{ mA}$		MAX.	80	75	100	mA
dv/dt	$V_D = V_{DRM}$ Gate Open $T_J = 125^\circ\text{C}$	400V	MIN.	600	500	700	$\text{V}/\mu\text{s}$
		600V		500	475	625	
		800V		475	400	575	
	1000V	--		--	500		
$(dv/dt)c$	$(di/dt)c = 21.6\text{ A/ms}$ $T_J = 125^\circ\text{C}$		MIN.	30	20	50	$\text{V}/\mu\text{s}$
t_{gt}	$I_G = 2 \times I_{GT}$ $PW = 15\mu\text{s}$ $I_T = 56.6\text{ A(pk)}$		TYP.	5			μs

Electrical Characteristics ($T_J = 25^\circ\text{C}$, unless otherwise specified) — Standard Triac (4 Quadrants)

Symbol	Test Conditions	Quadrant		Qxx40x3	Value		Unit
					Qxx40x4		
I_{GT}	$V_D = 12\text{ V}; R_L = 60\ \Omega$	I – II – III	MAX.	35	50	mA	
		IV	MAX.	70	100		
V_{GT}	$V_D = 12\text{ V}; R_L = 60\ \Omega$	ALL	MAX.	1.3	1.3	V	
V_{GD}	$V_D = V_{DRM}; R_L = 3.3\text{ k}\Omega; T_J = 125^\circ\text{C}$	ALL	MIN.	0.2	0.2	V	
I_H	$I_T = 400\text{mA (initial)}$		MAX.	80	80	mA	
dv/dt	$V_D = V_{DRM}; \text{Gate Open}; T_J = 125^\circ\text{C}$	400V	MIN.	400	400	V/ μs	
		600V		400	400		
		800V		400	400		
(dv/dt)c	(di/dt)c = 4.3 A/ms; $T_J = 125^\circ\text{C}$		MIN.	10	10	V/ μs	
t_{gt}	$I_G = 2 \times I_{GT}; \text{PW} = 15\ \mu\text{s}; I_T = 35.4\text{ A}$		TYP.	5	5	μs	
dv/dt	$V_D = V_{DRM}, \text{Gate Open}, T_J = 100^\circ\text{C}$		-	-	300	V/ μs	

Static Characteristics

Symbol	Test Conditions			Value	Unit	
V_{TM}	$I_{TM} = 56.6\text{ A}; t_p = 380\ \mu\text{s}$	$T_J = 25^\circ\text{C}$	MAX.	1.8	V	
I_{DRM} I_{RRM}	$V_D = V_{DRM} / V_{RRM}$	$T_J = 25^\circ\text{C}$	400 – 1000V	MAX.	20	μA
		$T_J = 125^\circ\text{C}$	400 – 800V	MAX.	5	mA
		$T_J = 100^\circ\text{C}$	1000V	MAX.	5	mA

Thermal Resistances

Symbol	Parameter		Value	Unit
$R_{\theta(J-C)}$	Junction to case (AC)	Qxx40KH6 Qxx40K5/7 Qxx40K4/J4 Qxx40K3	0.97	$^\circ\text{C/W}$
		Qxx40JH6 Qxx40J7	0.95	

Note: xx = voltage

Figure 1: Definition of Quadrants

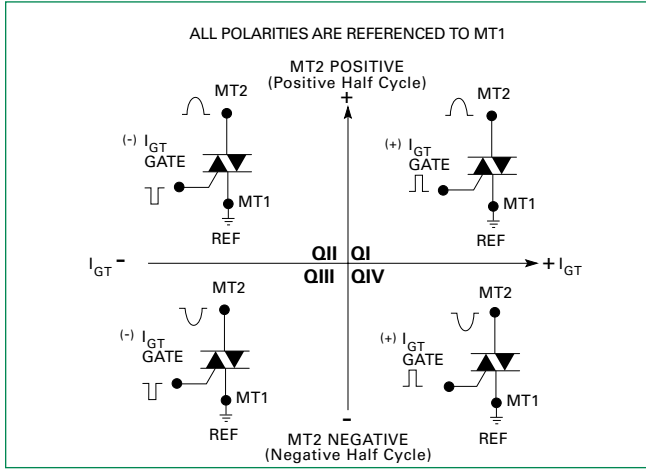

Figure 2: Normalized DC Gate Trigger Current for All Quadrants vs. Junction Temperature

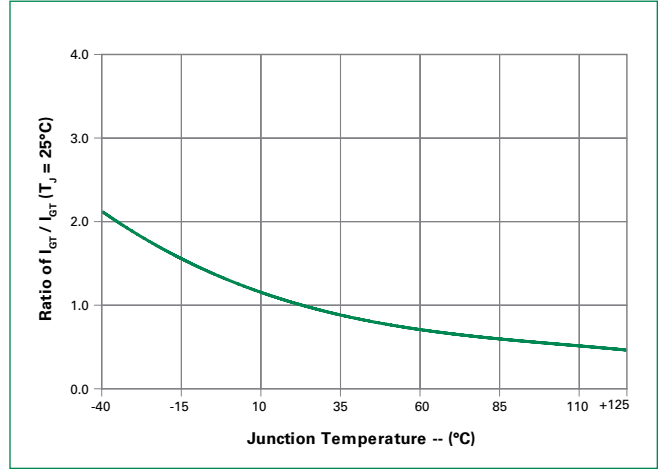

Figure 3: Normalized DC Holding Current vs. Junction Temperature

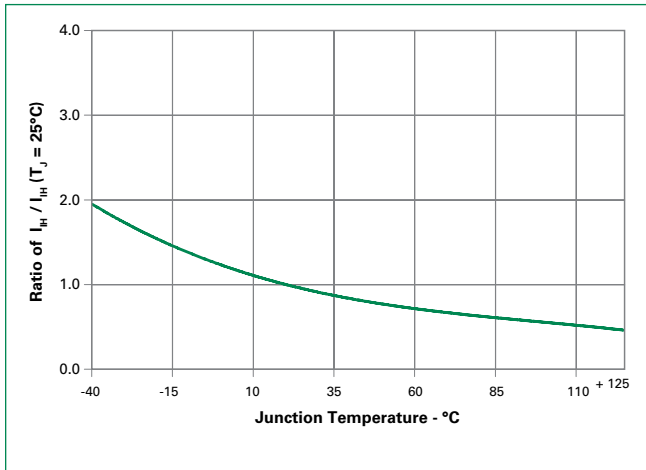

Figure 4: Normalized DC Gate Trigger Voltage for All Quadrants vs. Junction Temperature

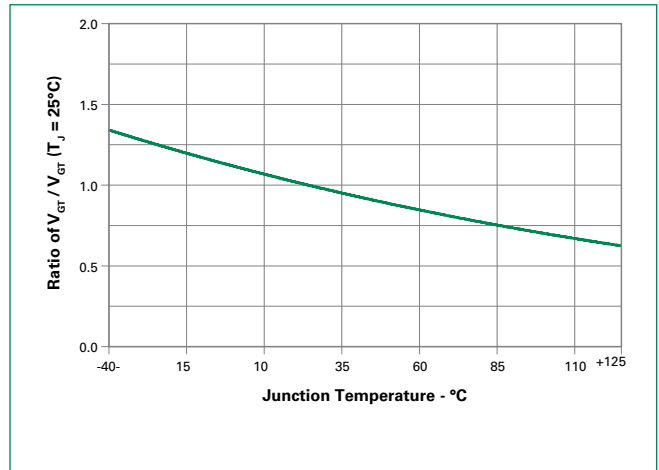

Figure 5: Power Dissipation (Typical) vs. RMS On-State Current

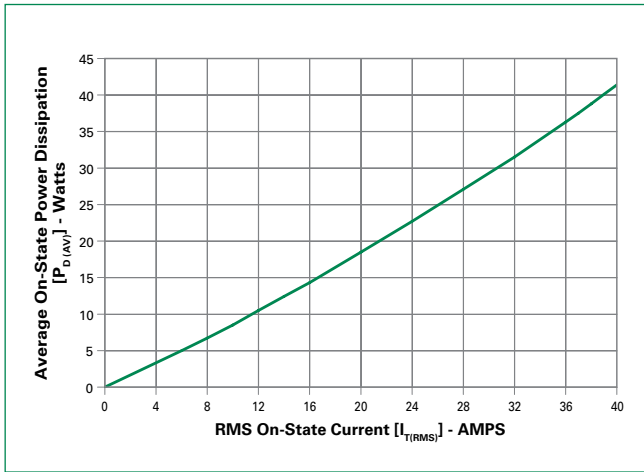

Figure 6: Maximum Allowable Case Temperature vs. On-State Current

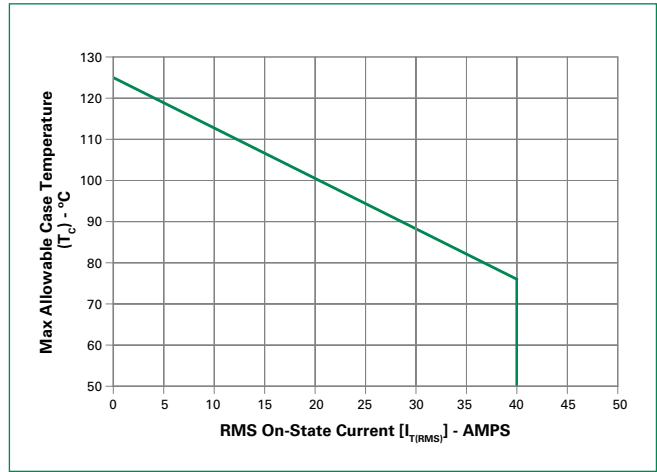

Figure 7: On-State Current vs. On-State Voltage (Typical)

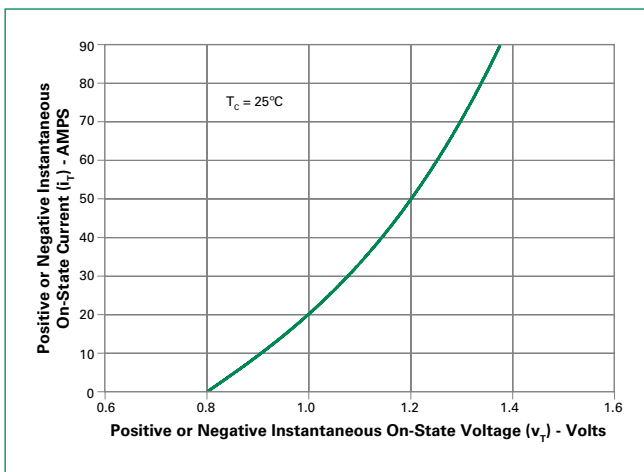
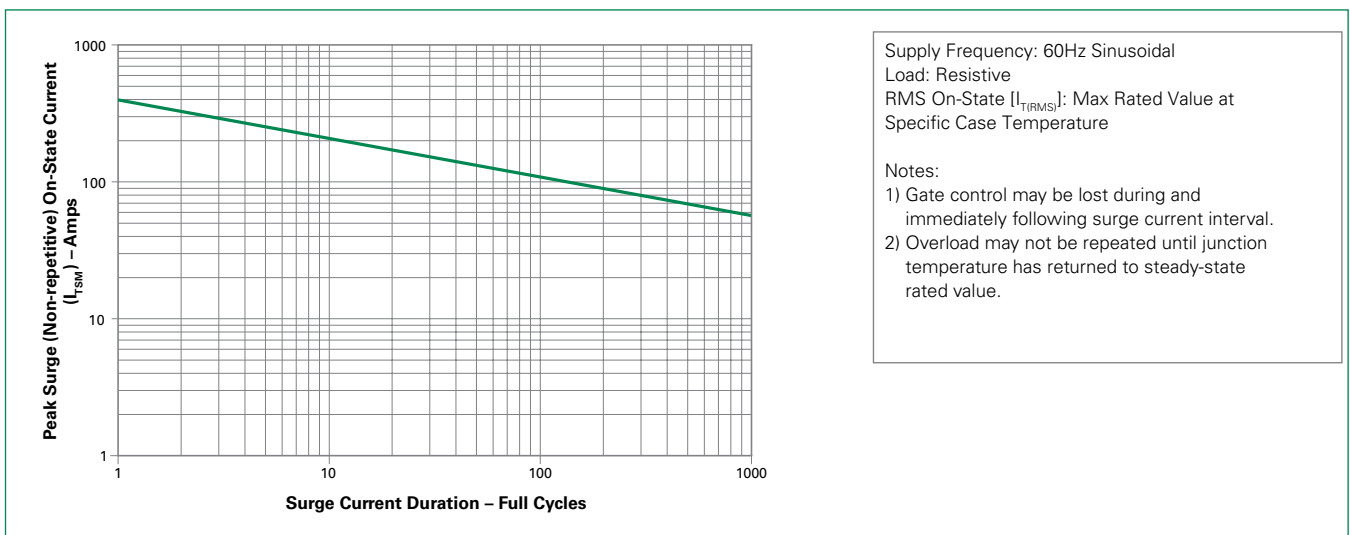
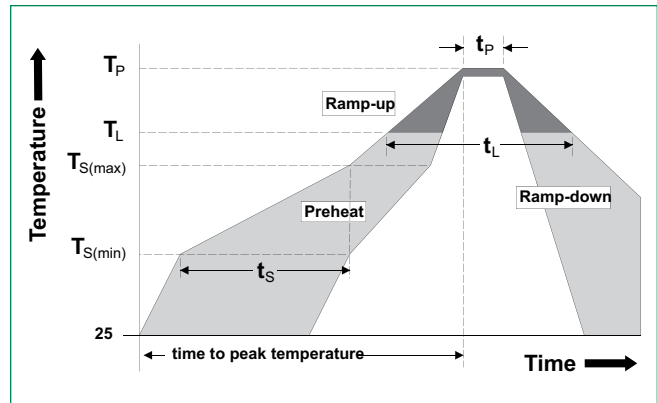

Figure 8: Surge Peak On-State Current vs. Number of Cycles



Soldering Parameters

Reflow Condition		Pb – Free assembly
Pre Heat	- Temperature Min ($T_{s(min)}$)	150°C
	- Temperature Max ($T_{s(max)}$)	200°C
	- Time (min to max) (t_s)	60 – 180 secs
Average ramp up rate (Liquidus Temp) (T_L) to peak		5°C/second max
$T_{s(max)}$ to T_L - Ramp-up Rate		5°C/second max
Reflow	- Temperature (T_L) (Liquidus)	217°C
	- Time (min to max) (t_s)	60 – 150 seconds
Peak Temperature (T_p)		260 ^{+0/-5} °C
Time within 5°C of actual peak Temperature (t_p)		20 – 40 seconds
Ramp-down Rate		5°C/second max
Time 25°C to peak Temperature (T_p)		8 minutes Max.
Do not exceed		280°C



Physical Specifications

Terminal Finish	100% Matte Tin-plated.
Body Material	UL Recognized compound meeting flammability rating V-0
Lead Material	Copper Alloy

Design Considerations

Careful selection of the correct component for the application's operating parameters and environment will go a long way toward extending the operating life of the Thyristor. Good design practice should limit the maximum continuous current through the main terminals to 75% of the component rating. Other ways to ensure long life for a power discrete semiconductor are proper heat sinking and selection of voltage ratings for worst case conditions. Overheating, overvoltage (including dv/dt), and surge currents are the main killers of semiconductors. Correct mounting, soldering, and forming of the leads also help protect against component damage.

Environmental Specifications

AC Blocking	MIL-STD-750, M-1040, Cond A Applied Peak AC voltage @ 125°C for 1008 hours
Temperature Cycling	MIL-STD-750, M-1051, 100 cycles; -40°C to +150°C; 15-min dwell-time
Temperature/Humidity	EIA / JEDEC, JESD22-A101 1008 hours; 320V - DC: 85°C; 85% rel humidity
High Temp Storage	MIL-STD-750, M-1031, 1008 hours; 150°C
Low-Temp Storage	1008 hours; -40°C
Resistance to Solder Heat	MIL-STD-750 Method 2031
Solderability	ANSI/J-STD-002, category 3, Test A
Lead Bend	MIL-STD-750, M-2036 Cond E

Dimensions – TO-218X (J Package) – Isolated Mounting Tab

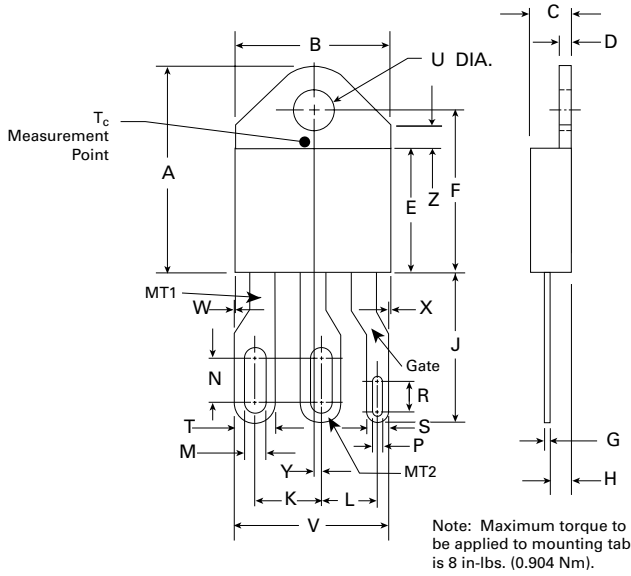

Dimension	Inches		Millimeters	
	Min	Max	Min	Max
A	0.810	0.835	20.57	21.21
B	0.610	0.630	15.49	16.00
C	0.178	0.188	4.52	4.78
D	0.055	0.070	1.40	1.78
E	0.487	0.497	12.37	12.62
F	0.635	0.655	16.13	16.64
G	0.022	0.029	0.56	0.74
H	0.075	0.095	1.91	2.41
J	0.575	0.625	14.61	15.88
K	0.256	0.264	6.50	6.71
L	0.220	0.228	5.58	5.79
M	0.080	0.088	2.03	2.24
N	0.169	0.177	4.29	4.49
P	0.034	0.042	0.86	1.07
R	0.113	0.121	2.87	3.07
S	0.086	0.096	2.18	2.44
T	0.156	0.166	3.96	4.22
U	0.161	0.165	4.10	4.20
V	0.603	0.618	15.31	15.70
W	0.000	0.005	0.00	0.13
X	0.003	0.012	0.07	0.30
Y	0.028	0.032	0.71	0.81
Z	0.085	0.095	2.17	2.42

Dimensions – TO-218AC (K Package) – Isolated Mounting Tab

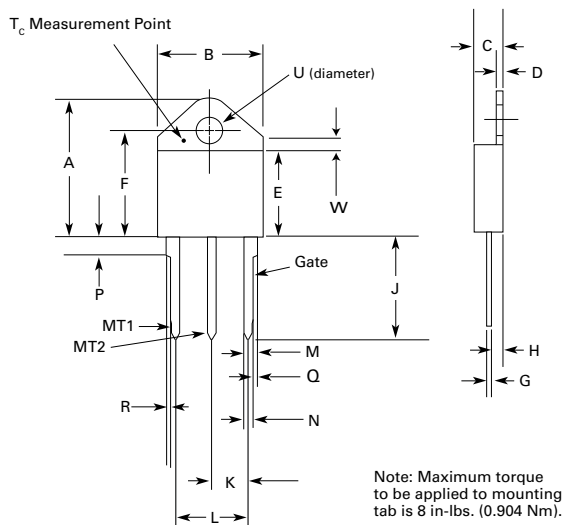

Dimension	Inches		Millimeters	
	Min	Max	Min	Max
A	0.810	0.835	20.57	21.21
B	0.610	0.630	15.49	16.00
C	0.178	0.188	4.52	4.78
D	0.055	0.070	1.40	1.78
E	0.487	0.497	12.37	12.62
F	0.635	0.655	16.13	16.64
G	0.022	0.029	0.56	0.74
H	0.075	0.095	1.91	2.41
J	0.575	0.625	14.61	15.88
K	0.211	0.219	5.36	5.56
L	0.422	0.437	10.72	11.10
M	0.058	0.068	1.47	1.73
N	0.045	0.055	1.14	1.40
P	0.095	0.115	2.41	2.92
Q	0.008	0.016	0.20	0.41
R	0.008	0.016	0.20	0.41
U	0.161	0.165	4.10	4.20
W	0.085	0.095	2.17	2.42

Product Selector

Part Number	Voltage				Gate Sensitivity Quadrants		I _{T(RMS)}	Type	Package
	400V	600V	800V	1000V	I – II – III	IV			
Qxx40KH6	X	X	X	X	80 mA	-	40 A	Alternistor Triac	TO-218AC
Qxx40JH6	X	X	X	-	80 mA	-	40 A	Alternistor Triac	TO-218X
Qxx40K5	X	X	X	-	50 mA	-	40 A	Alternistor Triac	TO-218AC
Qxx40K7	X	X	X	X	100 mA	-	40 A	Alternistor Triac	TO-218AC
Qxx40J7	X	X	X	-	100 mA	-	40 A	Alternistor Triac	TO-218X
Qxx40K4	X	X	X	X	50 mA	100 mA	40 A	Standard Triac	TO-218AC
Qxx40K3	-	-	X	-	35 mA	70 mA	40 A	Standard Triac	TO-218AC
Qxx40J4	-	-	-	X	50mA	100mA	40 A	Standard Triac	TO-218X

Note: xx = Voltage

Packing Options

Part Number	Marking	Weight	Packing Mode	Base Quantity
Qxx40KH6TP	Qxx40KH6	4.40 g	Tube Pack	250 (25 per tube)
Qxx40JH6TP	Qxx40JH6	5.23 g	Tube Pack	250 (25 per tube)
Qxx40K5TP	Qxx40K5	4.40 g	Tube Pack	250 (25 per tube)
Qxx40K7TP	Qxx40K7	4.40 g	Tube Pack	250 (25 per tube)
Qxx40J7TP	Qxx40J7	5.23 g	Tube Pack	250 (25 per tube)
Qxx40K4TP	Qxx40K4	4.40 g	Tube Pack	250 (25 per tube)
Qxx40K3TP	Qxx40K3	4.40g	Tube Pack	250(25 per tube)
Qxx40J4TP	Qxx40J4	5.23g	Tube Pack	250(25 per tube)

Note: xx = Voltage

Part Numbering System

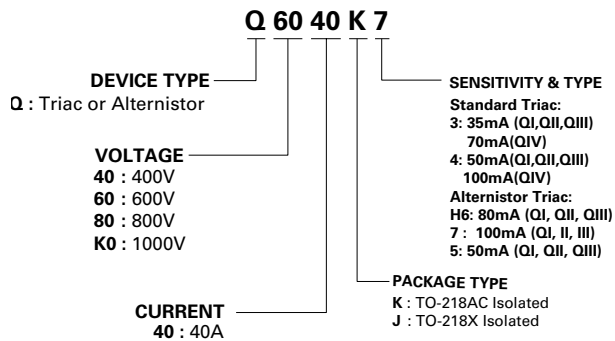

Part Marking System

TO-218 AC - (K Package)
TO-218 X - (J Package)

