

UFS Series N-Channel IGBT with Anti-Parallel Hyperfast Diode

40 A, 600 V

HGTG20N60B3D

The HGTG20N60B3D is a MOS gated high voltage switching device combining the best features of MOSFETs and bipolar transistors. The device has the high input impedance of a MOSFET and the low on-state conduction loss of a bipolar transistor. The much lower on-state voltage drop varies only moderately between 25°C and 150°C. The diode used in anti-parallel with the IGBT is the RHRP3060.

The IGBT is ideal for many high voltage switching applications operating at moderate frequencies where low conduction losses are essential.

Formerly developmental type TA49016.

Features

- 40 A, 600 V at $T_C = 25^\circ\text{C}$
- Typical Fall Time 140 ns at 150°C
- Short Circuit Rated
- Low Conduction Loss
- Hyperfast Anti-Parallel Diode
- This is a Pb-Free Device



ON Semiconductor®

www.onsemi.com

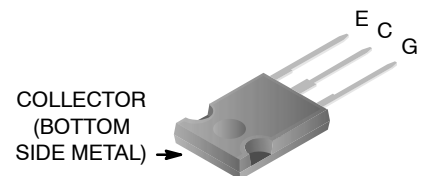
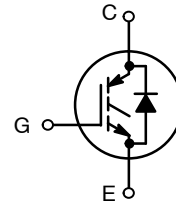

TO-247-3LD SHORT LEAD
CASE 340CK
JEDEC STYLE

MARKING DIAGRAM

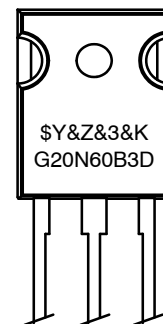

\$Y = ON Semiconductor Logo
&Z = Assembly Plant Code
&3 = Numeric Date Code
&K = Lot Code
G20N60B3D = Specific Device Code

ORDERING INFORMATION

See detailed ordering and shipping information on page 7 of this data sheet.

HGTG20N60B3D

ABSOLUTE MAXIMUM RATINGS (T_C = 25°C unless otherwise specified)

Parameter	Symbol	HGTG20N60B3D	Unit
Collector to Emitter Voltage	BV _{CES}	600	V
Collector to Gate Voltage, R _{GE} = 1 MΩ	BV _{CGR}	600	V
Collector Current Continuous At T _C = 25°C At T _C = 110°C	I _{C25} I _{C110}	40 20	A A
Average Diode Forward Current at 110°C	I _(AVG)	20	A
Collector Current Pulsed (Note 1)	I _{CM}	160	A
Gate to Emitter Voltage Continuous	V _{GES}	±20	V
Gate to Emitter Voltage Pulsed	V _{GEM}	±30	V
Switching Safe Operating Area at T _C = 150°C	SSOA	30 A at 600 V	
Power Dissipation Total at T _C = 25°C	P _D	165	W
Power Dissipation Derating T _C > 25°C		1.32	W/°C
Operating and Storage Junction Temperature Range	T _J , T _{STG}	-40 to 150	°C
Maximum Lead Temperature for Soldering	T _L	260	°C
Short Circuit Withstand Time (Note 2) at V _{GE} = 15 V	t _{SC}	4	μs
Short Circuit Withstand Time (Note 2) at V _{GE} = 10 V	t _{SC}	10	μs

Stresses exceeding those listed in the Maximum Ratings table may damage the device. If any of these limits are exceeded, device functionality should not be assumed, damage may occur and reliability may be affected.

1. Repetitive Rating: Pulse width limited by maximum junction temperature.
2. V_{CE} = 360 V, T_C = 125°C, R_G = 25 Ω

ELECTRICAL CHARACTERISTICS (T_C = 25°C unless otherwise specified)

Parameter	Symbol	Test Condition	Min	Typ	Max	Unit	
Collector to Emitter Breakdown Voltage	BV _{CES}	I _C = 250 μA, V _{GE} = 0 V	600	-	-	V	
Collector to Emitter Leakage Current	I _{CES}	V _{CE} = BV _{CES}	T _C = 25°C	-	-	250	μA
			T _C = 150°C	-	-	2.0	mA
Collector to Emitter Saturation Voltage	V _{CE(SAT)}	I _C = I _{C110} , V _{GE} = 15 V	T _C = 25°C	-	1.8	2.0	V
			T _C = 150°C	-	2.1	2.5	V
Gate to Emitter Threshold Voltage	V _{GE(TH)}	I _C = 250 μA, V _{CE} = V _{GE}	3.0	5.0	6.0	V	
Gate to Emitter Leakage Current	I _{GES}	V _{GE} = ±20 V	-	-	±100	nA	
Switching SOA	SSOA	T _C = 150°C, V _{GE} = 15 V, R _G = 10 Ω, L = 45 μH	V _{CE} = 480 V	100	-	-	A
			V _{CE} = 600 V	30	-	-	A
Gate to Emitter Plateau Voltage	V _{GEP}	I _C = I _{C110} , V _{CE} = 0.5 BV _{CES}	-	8.0	-	V	
On-State Gate Charge	Q _{G(ON)}	I _C = I _{C110} , V _{CE} = 0.5 BV _{CES}	V _{GE} = 15 V	-	80	105	nC
			V _{GE} = 20 V	-	105	135	nC
Current Turn-On Delay Time	t _{d(ON)I}	T _C = 150°C, I _{CE} = I _{C110} , V _{CE} = 0.8 BV _{CES} , V _{GE} = 15 V, R _G = 10 Ω, L = 100 μH	-	25	-	ns	
Current Rise Time	t _{rl}		-	20	-	ns	
Current Turn-Off Delay Time	t _{d(OFF)I}		-	220	275	ns	
Current Fall Time	t _{fl}		-	140	175	ns	
Turn-On Energy	E _{ON}		-	475	-	μJ	
Turn-Off Energy (Note 3)	E _{OFF}		-	1050	-	μJ	
Diode Forward Voltage	V _{EC}		I _{EC} = 20 A	-	1.5	1.9	V
Diode Reverse Recovery Time	t _{rr}	I _{EC} = 20 A, dI _{EC} /dt = 100 A/μs	-	-	55	ns	
		I _{EC} = 1 A, dI _{EC} /dt = 100 A/μs	-	-	45	ns	

HGTG20N60B3D

ELECTRICAL CHARACTERISTICS ($T_C = 25^\circ\text{C}$ unless otherwise specified) (continued)

Parameter	Symbol	Test Condition	Min	Typ	Max	Unit
Thermal Resistance	$R_{\theta JC}$	IGBT	-	-	0.76	$^\circ\text{C/W}$
		Diode	-	-	1.2	$^\circ\text{C/W}$

Product parametric performance is indicated in the Electrical Characteristics for the listed test conditions, unless otherwise noted. Product performance may not be indicated by the Electrical Characteristics if operated under different conditions.

3. Turn-Off Energy Loss (E_{OFF}) is defined as the integral of the instantaneous power loss starting at the trailing edge of the input pulse and ending at the point where the collector current equals zero ($I_{CE} = 0\text{ A}$). The HGTG20N60B3D was tested per JEDEC standard No. 24-1 Method for Measurement of Power Device Turn-Off Switching Loss. This test method produces the true total Turn-Off Energy Loss. Turn-On losses include diode losses.

TYPICAL PERFORMANCE CURVES

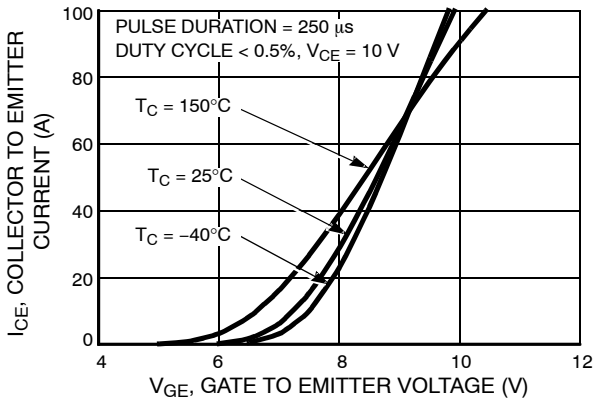

Figure 1. TRANSFER CHARACTERISTICS

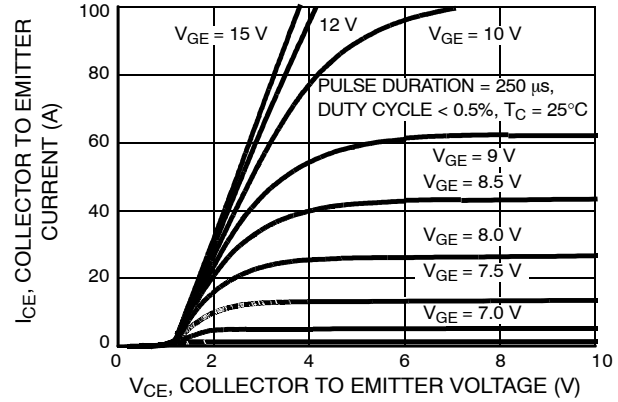

Figure 2. SATURATION CHARACTERISTICS

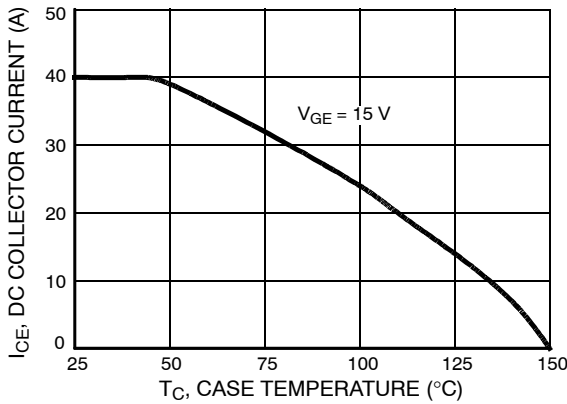

Figure 3. DC COLLECTOR CURRENT vs. CASE TEMPERATURE

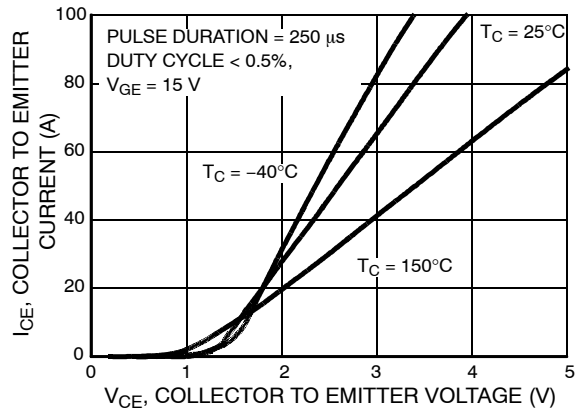

Figure 4. COLLECTOR TO EMITTER ON-STATE VOLTAGE

HGTG20N60B3D

TYPICAL PERFORMANCE CURVES (continued)

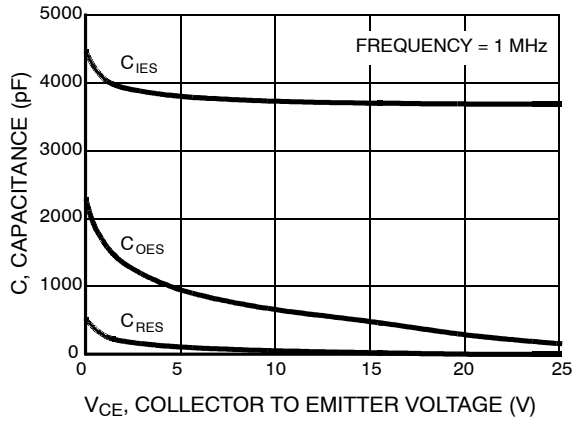

Figure 5. CAPACITANCE vs. COLLECTOR TO EMITTER VOLTAGE

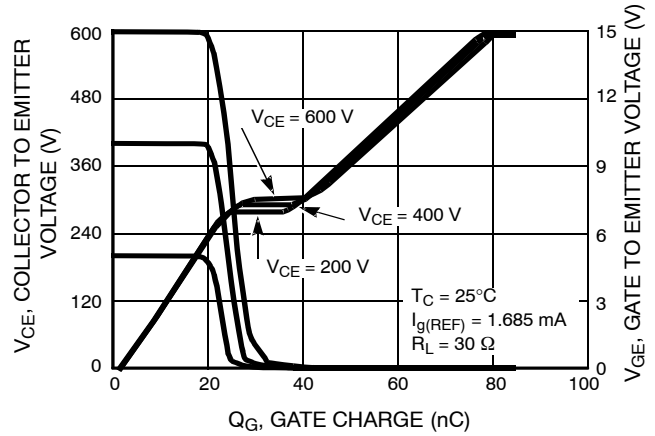

Figure 6. GATE CHARGE WAVEFORMS

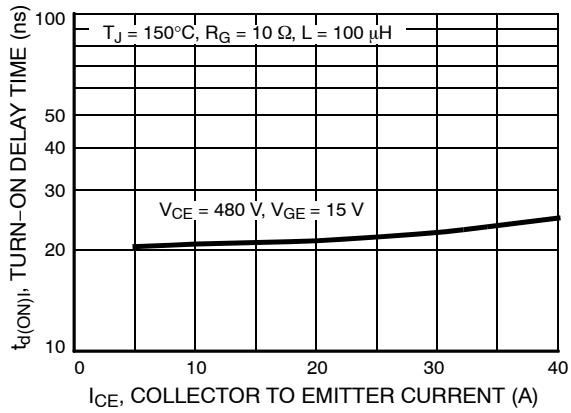

Figure 7. TURN-ON DELAY TIME vs. COLLECTOR TO EMITTER CURRENT

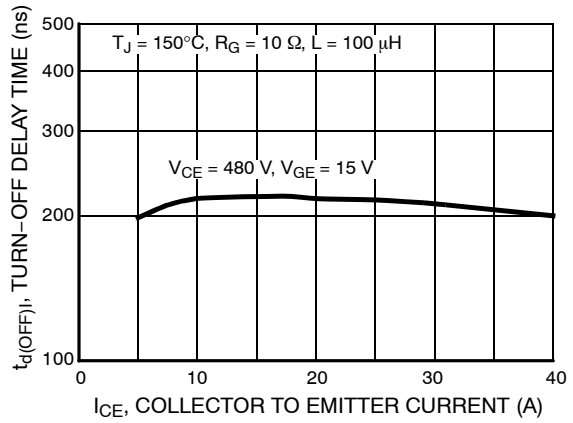

Figure 8. TURN-OFF DELAY TIME vs. COLLECTOR TO EMITTER CURRENT

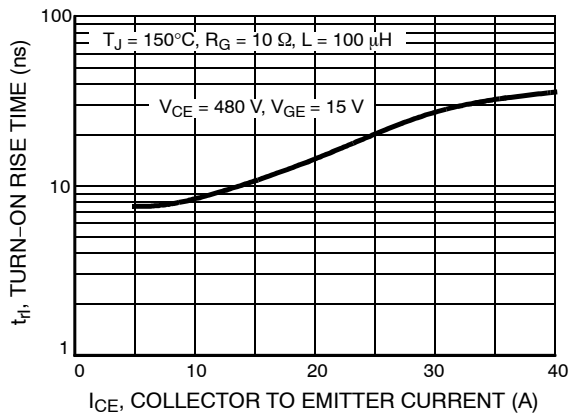

Figure 9. TURN-ON RISE TIME vs. COLLECTOR TO EMITTER CURRENT

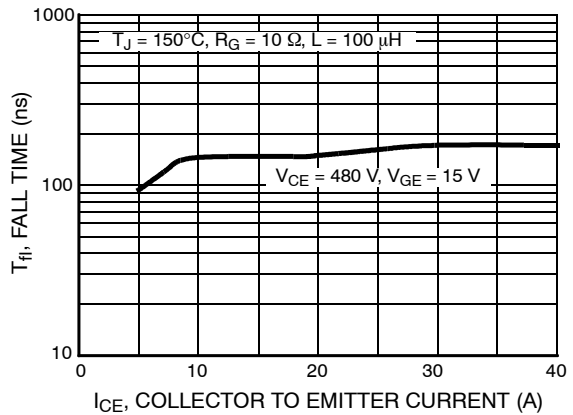

Figure 10. TURN-OFF FALL TIME vs. COLLECTOR TO EMITTER CURRENT

HGTG20N60B3D

TYPICAL PERFORMANCE CURVES (continued)

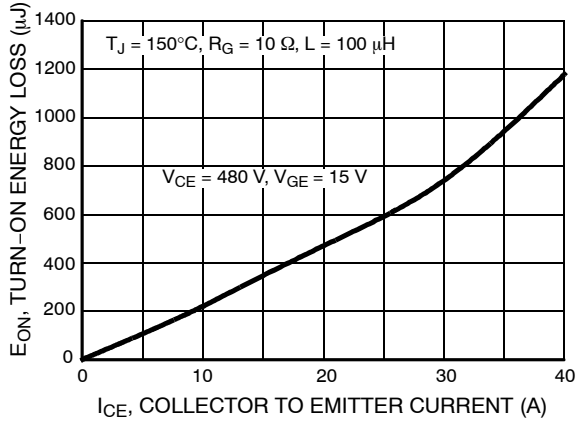

Figure 11. TURN-ON ENERGY LOSS vs. COLLECTOR TO EMITTER CURRENT

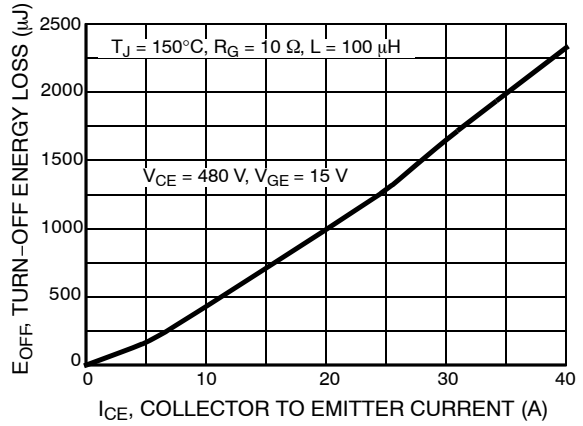

Figure 12. TURN-OFF ENERGY LOSS vs. COLLECTOR TO EMITTER CURRENT

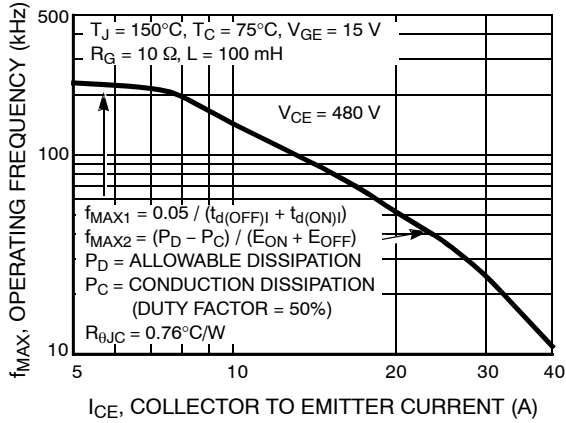

Figure 13. OPERATING FREQUENCY vs. COLLECTOR TO EMITTER CURRENT

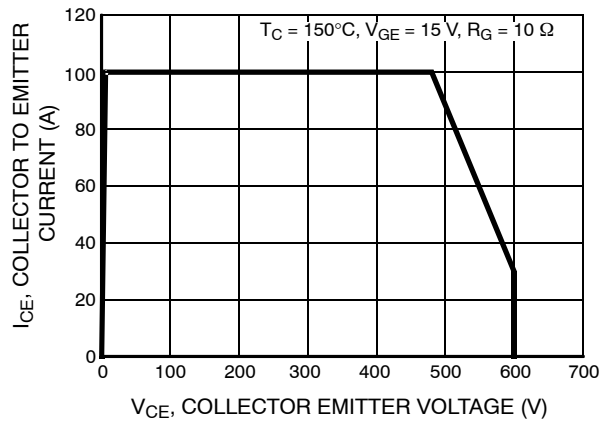

Figure 14. SWITCHING SAFE OPERATING AREA

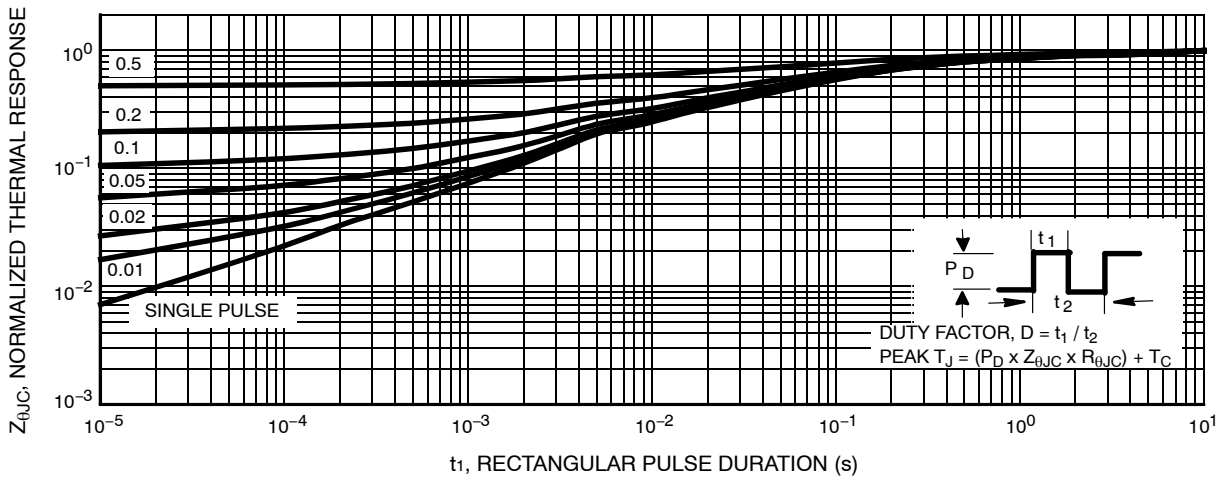

Figure 15. IGBT NORMALIZED TRANSIENT THERMAL RESPONSE, JUNCTION TO CASE

HGTG20N60B3D

TYPICAL PERFORMANCE CURVES (continued)

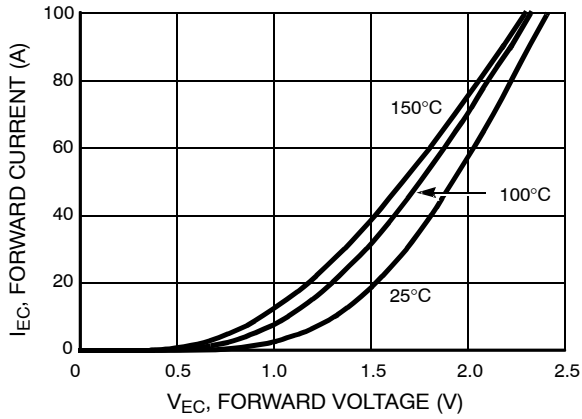

Figure 16. DIODE FORWARD CURRENT vs. FORWARD VOLTAGE DROP

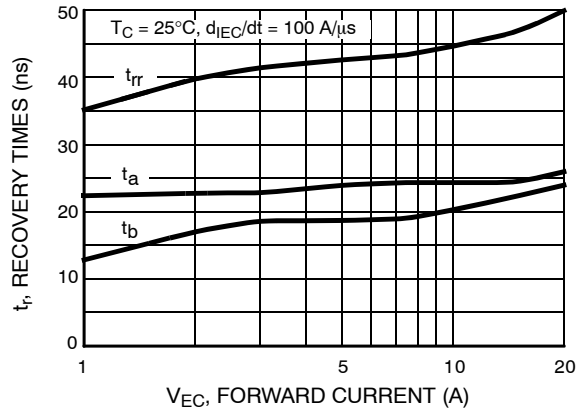

Figure 17. RECOVERY TIMES vs. FORWARD CURRENT

TEST CIRCUIT AND WAVEFORMS

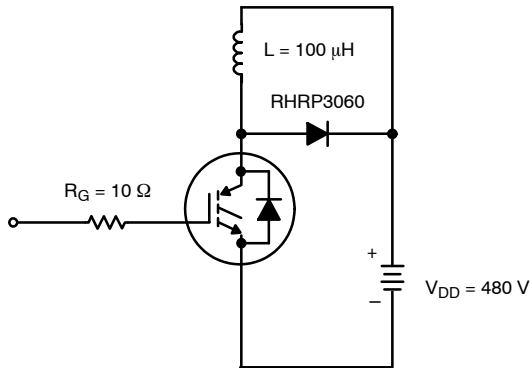

Figure 18. INDUCTIVE SWITCHING TEST CIRCUIT

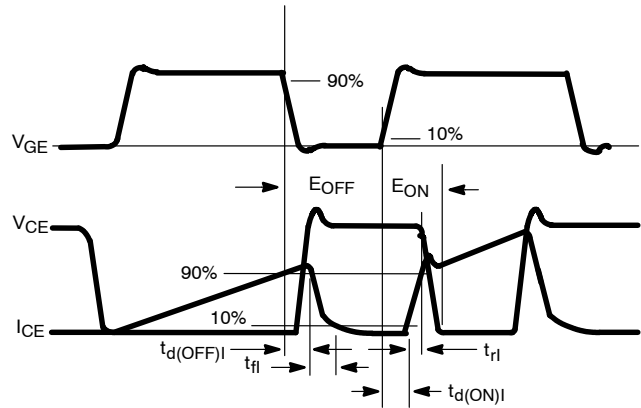

Figure 19. SWITCHING TEST WAVEFORMS

HGTG20N60B3D

HANDLING PRECAUTIONS FOR IGBTs

Insulated Gate Bipolar Transistors are susceptible to gate-insulation damage by the electrostatic discharge of energy through the devices. When handling these devices, care should be exercised to assure that the static charge built in the handler's body capacitance is not discharged through the device. With proper handling and discharge procedures, however, IGBTs are currently being extensively used in production by numerous equipment manufacturers in military, industrial and consumer applications, with virtually no damage problems due to electrostatic discharge. IGBTs can be handled safely if the following basic precautions are taken:

1. Prior to assembly into a circuit, all leads should be kept shorted together either by the use of metal shorting springs or by the insertion into conductive material such as "ECCOSORB™ LD26" or equivalent.
2. When devices are removed by hand from their carriers, the hand being used should be grounded by any suitable means – for example, with a metallic wristband.
3. Tips of soldering irons should be grounded.
4. 1. Devices should never be inserted into or removed from circuits with power on.
5. *Gate Voltage Rating* – Never exceed the gate-voltage rating of V_{GEM} . Exceeding the rated V_{GE} can result in permanent damage to the oxide layer in the gate region.
6. *Gate Termination* – The gates of these devices are essentially capacitors. Circuits that leave the gate open-circuited or floating should be avoided. These conditions can result in turn-on of the device due to voltage buildup on the input capacitor due to leakage currents or pickup.
7. *Gate Protection* - These devices do not have an internal monolithic zener diode from gate to emitter. If gate protection is required an external zener is recommended.

OPERATING FREQUENCY INFORMATION

Operating frequency information for a typical device (Figure 13) is presented as a guide for estimating device performance for a specific application. Other typical frequency vs collector current (I_{CE}) plots are possible using the information shown for a typical unit in Figures 4, 7, 8, 11 and 12. The operating frequency plot (Figure 13) of a typical device shows f_{MAX1} or f_{MAX2} whichever is smaller at each point. The information is based on measurements of a typical device and is bounded by the maximum rated junction temperature.

f_{MAX1} is defined by $f_{MAX1} = 0.05 / (t_{d(OFF)I} t_{d(ON)I})$. Deadtime (the denominator) has been arbitrarily held to 10% of the on-state time for a 50% duty factor. Other definitions are possible. $t_{d(OFF)I}$ and $t_{d(ON)I}$ are defined in Figure 19.

Device turn-off delay can establish an additional frequency limiting condition for an application other than T_{JM} . $t_{d(OFF)I}$ is important when controlling output ripple under a lightly loaded condition.

f_{MAX2} is defined by $f_{MAX2} = (P_D - P_C) / (E_{OFF} + E_{ON})$. The allowable dissipation (P_D) is defined by $P_D = (T_{JM} - T_C) / R_{\theta JC}$. The sum of device switching and conduction losses must not exceed P_D . A 50% duty factor was used (Figure 13) and the conduction losses (P_C) are approximated by $P_C = (V_{CE} \times I_{CE}) / 2$.

E_{ON} and E_{OFF} are defined in the switching waveforms shown in Figure 19. E_{ON} is the integral of the instantaneous power loss ($I_{CE} \times V_{CE}$) during turn-on and E_{OFF} is the integral of the instantaneous power loss during turn-off. All tail losses are included in the calculation for E_{OFF} ; i.e. the collector current equals zero ($I_{CE} = 0$).

ORDERING INFORMATION

Part Number	Package	Brand	Shipping
HGTG20N60B3D	TO-247	G20N60B3D	450 Units / Tube

NOTE: When ordering, use the entire part number.



TO-247-3LD SHORT LEAD
CASE 340CK
ISSUE A

DATE 31 JAN 2019

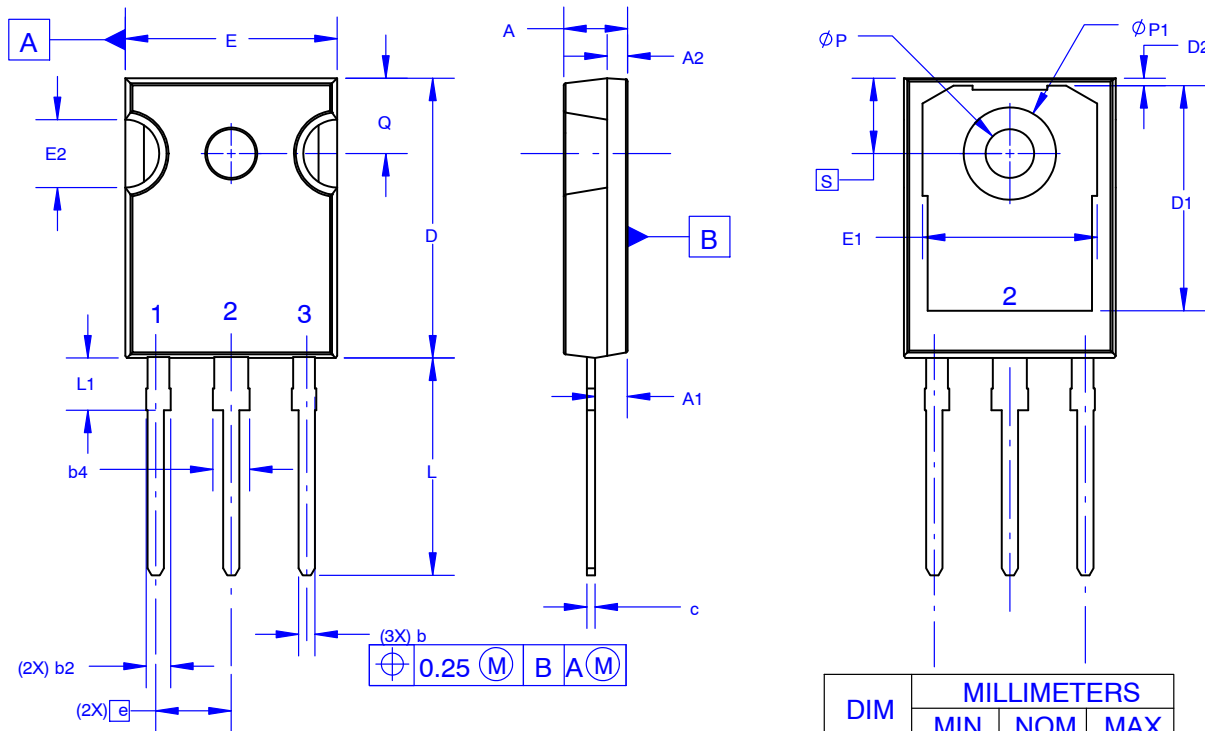

NOTES: UNLESS OTHERWISE SPECIFIED.

- A. DIMENSIONS ARE EXCLUSIVE OF BURRS, MOLD FLASH, AND TIE BAR EXTRUSIONS.
- B. ALL DIMENSIONS ARE IN MILLIMETERS.
- C. DRAWING CONFORMS TO ASME Y14.5 - 2009.
- D. DIMENSION A1 TO BE MEASURED IN THE REGION DEFINED BY L1.
- E. LEAD FINISH IS UNCONTROLLED IN THE REGION DEFINED BY L1.

GENERIC MARKING DIAGRAM*

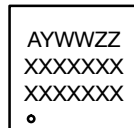

XXXX = Specific Device Code
 A = Assembly Location
 Y = Year
 WW = Work Week
 ZZ = Assembly Lot Code

*This information is generic. Please refer to device data sheet for actual part marking. Pb-Free indicator, "G" or microdot "•", may or may not be present. Some products may not follow the Generic Marking.

DIM	MILLIMETERS		
	MIN	NOM	MAX
A	4.58	4.70	4.82
A1	2.20	2.40	2.60
A2	1.40	1.50	1.60
b	1.17	1.26	1.35
b2	1.53	1.65	1.77
b4	2.42	2.54	2.66
c	0.51	0.61	0.71
D	20.32	20.57	20.82
D1	13.08	~	~
D2	0.51	0.93	1.35
E	15.37	15.62	15.87
E1	12.81	~	~
E2	4.96	5.08	5.20
e	~	5.56	~
L	15.75	16.00	16.25
L1	3.69	3.81	3.93
ØP	3.51	3.58	3.65
ØP1	6.60	6.80	7.00
Q	5.34	5.46	5.58
S	5.34	5.46	5.58

DOCUMENT NUMBER:	98AON13851G	Electronic versions are uncontrolled except when accessed directly from the Document Repository. Printed versions are uncontrolled except when stamped "CONTROLLED COPY" in red.
DESCRIPTION:	TO-247-3LD SHORT LEAD	PAGE 1 OF 1

ON Semiconductor and are trademarks of Semiconductor Components Industries, LLC dba ON Semiconductor or its subsidiaries in the United States and/or other countries. ON Semiconductor reserves the right to make changes without further notice to any products herein. ON Semiconductor makes no warranty, representation or guarantee regarding the suitability of its products for any particular purpose, nor does ON Semiconductor assume any liability arising out of the application or use of any product or circuit, and specifically disclaims any and all liability, including without limitation special, consequential or incidental damages. ON Semiconductor does not convey any license under its patent rights nor the rights of others.

onsemi, **Onsemi**, and other names, marks, and brands are registered and/or common law trademarks of Semiconductor Components Industries, LLC dba "**onsemi**" or its affiliates and/or subsidiaries in the United States and/or other countries. **onsemi** owns the rights to a number of patents, trademarks, copyrights, trade secrets, and other intellectual property. A listing of **onsemi**'s product/patent coverage may be accessed at www.onsemi.com/site/pdf/Patent-Marking.pdf. **onsemi** reserves the right to make changes at any time to any products or information herein, without notice. The information herein is provided "as-is" and **onsemi** makes no warranty, representation or guarantee regarding the accuracy of the information, product features, availability, functionality, or suitability of its products for any particular purpose, nor does **onsemi** assume any liability arising out of the application or use of any product or circuit, and specifically disclaims any and all liability, including without limitation special, consequential or incidental damages. Buyer is responsible for its products and applications using **onsemi** products, including compliance with all laws, regulations and safety requirements or standards, regardless of any support or applications information provided by **onsemi**. "Typical" parameters which may be provided in **onsemi** data sheets and/or specifications can and do vary in different applications and actual performance may vary over time. All operating parameters, including "Typicals" must be validated for each customer application by customer's technical experts. **onsemi** does not convey any license under any of its intellectual property rights nor the rights of others. **onsemi** products are not designed, intended, or authorized for use as a critical component in life support systems or any FDA Class 3 medical devices or medical devices with a same or similar classification in a foreign jurisdiction or any devices intended for implantation in the human body. Should Buyer purchase or use **onsemi** products for any such unintended or unauthorized application, Buyer shall indemnify and hold **onsemi** and its officers, employees, subsidiaries, affiliates, and distributors harmless against all claims, costs, damages, and expenses, and reasonable attorney fees arising out of, directly or indirectly, any claim of personal injury or death associated with such unintended or unauthorized use, even if such claim alleges that **onsemi** was negligent regarding the design or manufacture of the part. **onsemi** is an Equal Opportunity/Affirmative Action Employer. This literature is subject to all applicable copyright laws and is not for resale in any manner.

ADDITIONAL INFORMATION

TECHNICAL PUBLICATIONS:

Technical Library: www.onsemi.com/design/resources/technical-documentation
onsemi Website: www.onsemi.com

ONLINE SUPPORT: www.onsemi.com/support

For additional information, please contact your local Sales Representative at www.onsemi.com/support/sales