

# SINGLE SUPPLY DUAL COMPARATOR

## ■ GENERAL DESCRIPTION

The NJM12903 is a single-supply dual voltage comparator, which can operate from 2V supply. The features are low input offset voltage, low input bias current and low current consumption.

The NJM12903 compare the input signal to 0V (ground) due to the Darlington PNP input stage. In addition, small packages TVSP, VSP and SSOP are available. The NJM12903 is suitable for any kind of signal comparator.

## ■ FEATURES

- Operating Voltage                    +2V~+14V
- Open Collector Output
- Bipolar Technology
- Package Outline                    DIP8, SIP8, DMP8, SSOP8  
SOP8 JEDEC 150mil  
MSOP8 (VSP8) MEET JEDEC MO-187-DA  
MSOP8 (TVSP8) MEET JEDEC MO-187-DA / THIN TYPE

## ■ PACKAGE OUTLINE

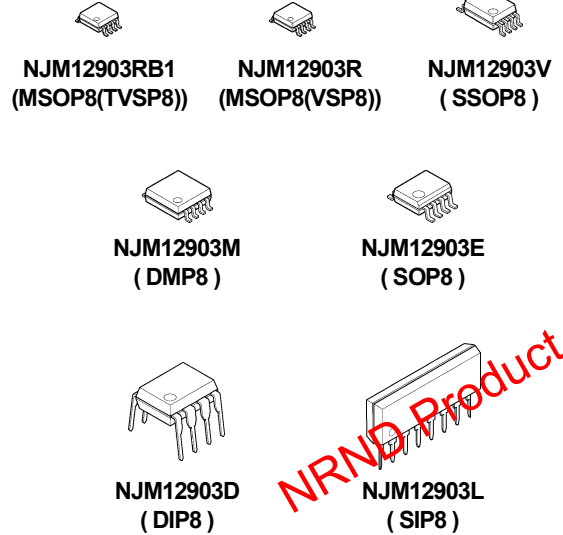

NRND Product

## ■ PIN CONFIGURATION

( Top View )

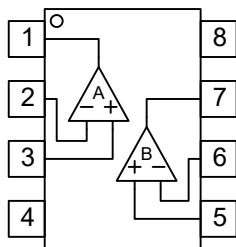

NJM12903D/NJM12903M  
NJM12903E/NJM12903V  
NJM12903R/NJM12903RB1

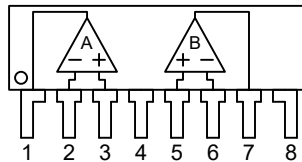

NJM12903L

### PIN FUNCTION

1. A OUTPUT
2. A -INPUT
3. A +INPUT
4. GND
5. B +INPUT
6. B -INPUT
7. B OUTPUT
8. V<sup>+</sup>

## ■ EQUIVALENT CIRCUIT ( 1/2 Shown )

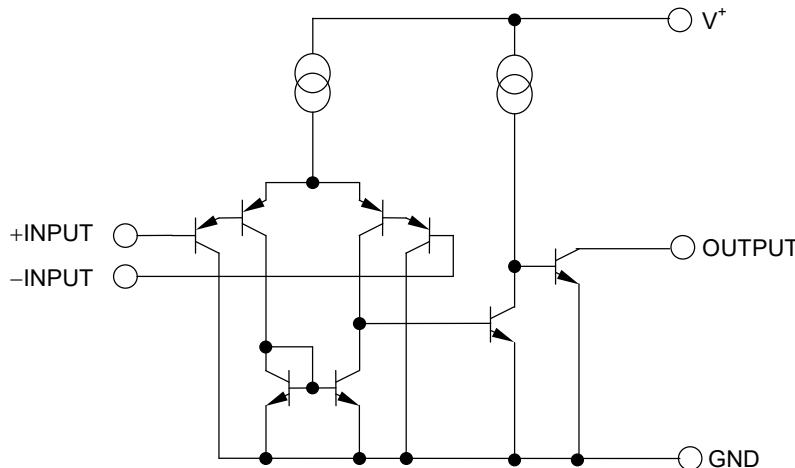

### ■ ABSOLUTE MAXIMUM RATINGS( Ta=25°C )

PARAMETER	SYMBOL	RATING	UNIT
Supply Voltage	V <sup>+</sup>	15	V
Differential Input Voltage	V <sub>ID</sub>	14 (note1)	V
Common Mode Input Voltage	V <sub>IC</sub>	-0.3~+14 (note1)	V
Power Dissipation	P <sub>D</sub>	DIP8 500	mW
		DMP8 300	
		EMP8 300	
		SSOP8 250	
		MSOP8(VSP8/TVSP8) 320	
		SIP8 800	
Operating Temperature Range	Topr	-40~+85	°C
Storage Temperature Range	Tstg	-50~+125	°C

(Note1) For supply voltage less than 14V, the maximum input voltage is equal to the supply voltage.

### ■ ELECTRICAL CHARACTERISTICS( V<sup>+</sup>=5V, Ta=25°C unless otherwise specified )

PARAMETER	SYMBOL	TEST CONDITION	MIN.	TYP.	MAX.	UNIT
Operating Voltage	V <sub>OPR</sub>		2	-	14	V
Input Offset Voltage	V <sub>IO</sub>	Rs=0Ω, Vo≈1.4V	-	1	4	mV
Input Offset Current	I <sub>IO</sub>		-	5	50	nA
Input Bias Current	I <sub>B</sub>		-	30	200	nA
Large Signal Voltage Gain	A <sub>V</sub>	R <sub>L</sub> =15kΩ	-	106	-	dB
Common Mode Input Voltage Range	V <sub>ICM</sub>		0~3.5	-	-	V
Response Time	t <sub>R</sub>	R <sub>L</sub> =5.1kΩ	-	0.5	-	μs
Output Sink Current	I <sub>SINK</sub>	V <sub>IN+</sub> =0V, V <sub>IN-</sub> =1V, Vo=1.5V	6	10	-	mA
Output Saturation Voltage	V <sub>SAT</sub>	V <sub>IN+</sub> =0V, V <sub>IN-</sub> =1V, I <sub>SINK</sub> =3mA	-	80	300	mV
Output Leakage Current	I <sub>LEAK</sub>	V <sub>IN+</sub> =1V, V <sub>IN-</sub> =0V, Vo=5V	-	0.1	1	μA
Supply Current	I <sub>CC</sub>		-	0.4	1	mA

■ TYPICAL CHARACTERISTICS

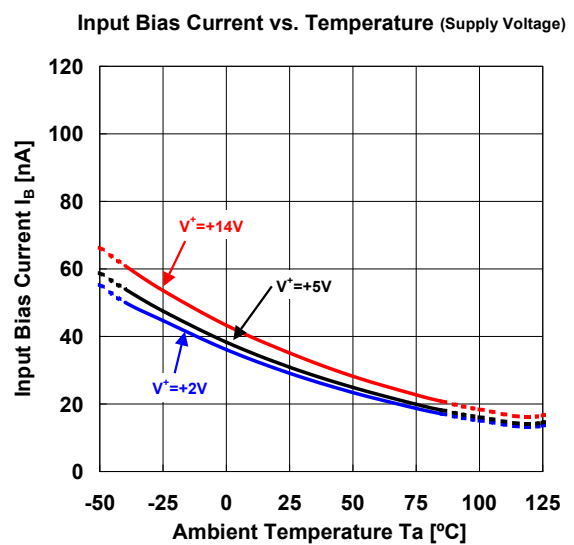
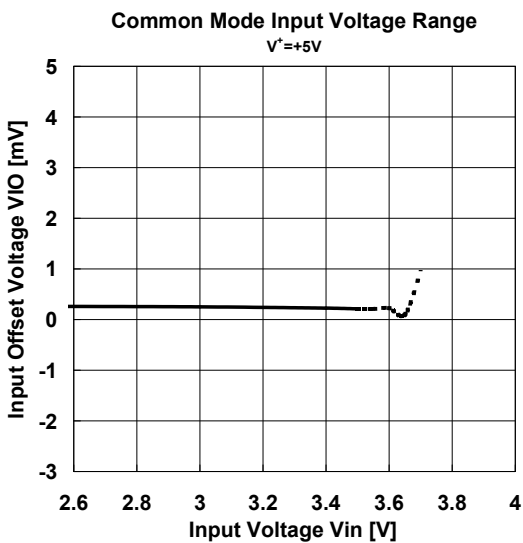
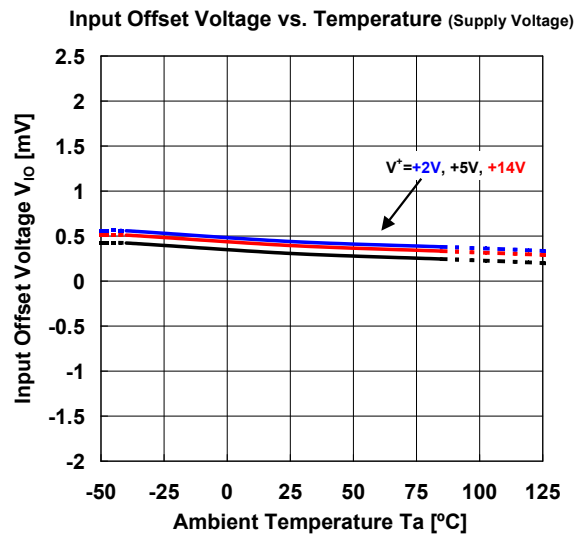
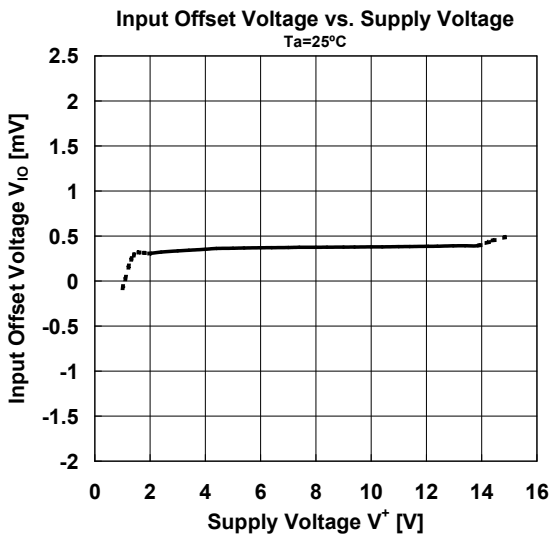
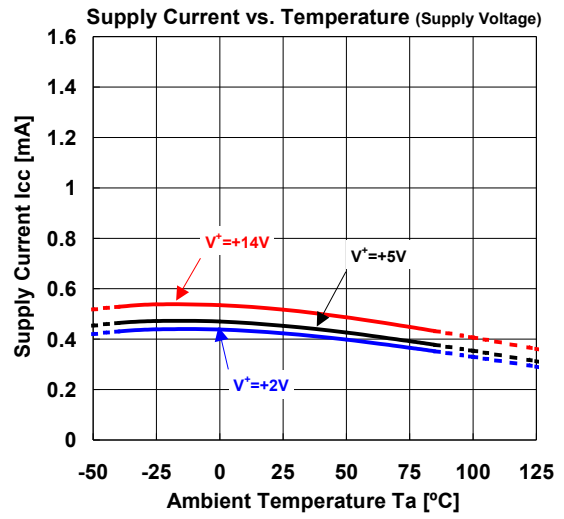
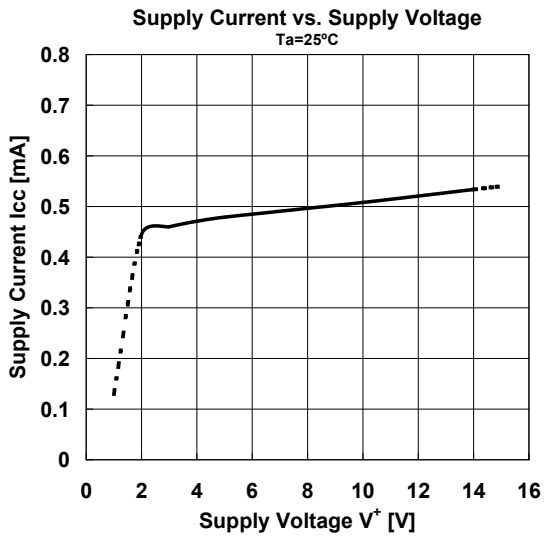

■ TYPICAL CHARACTERISTICS

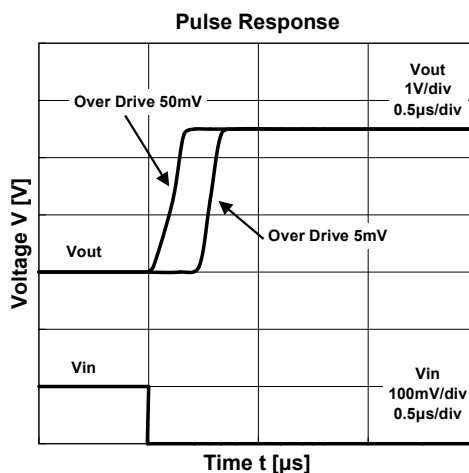
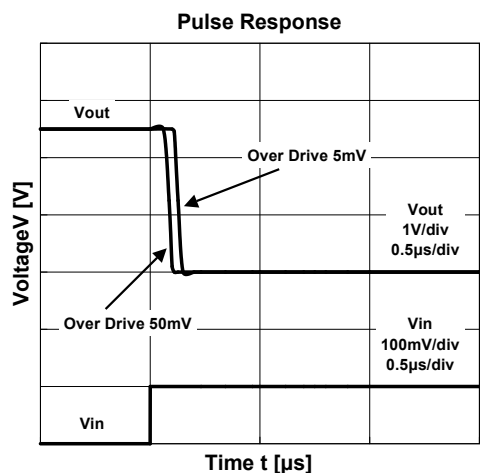
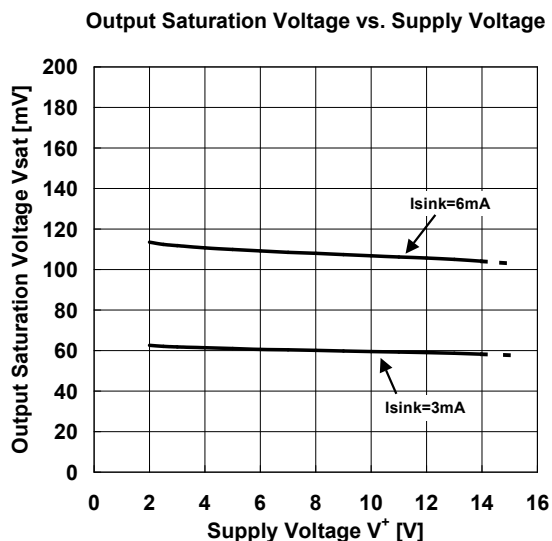
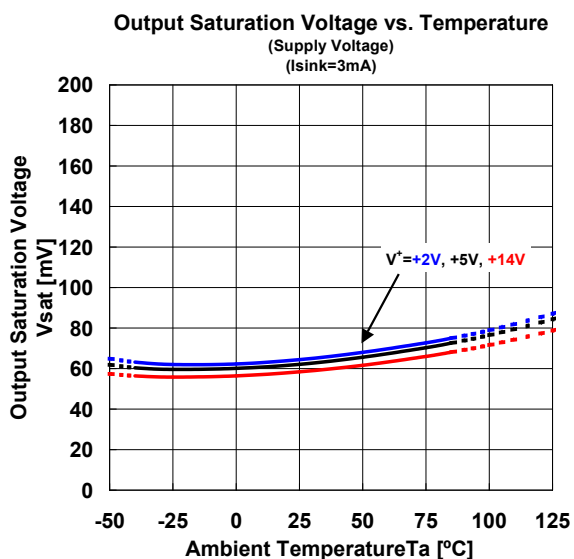
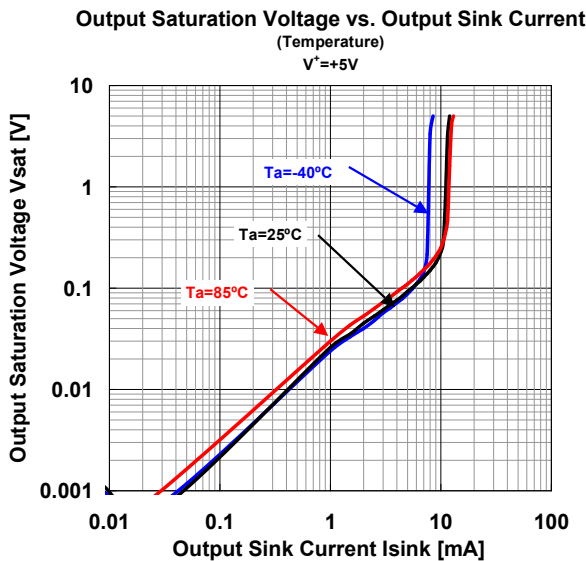
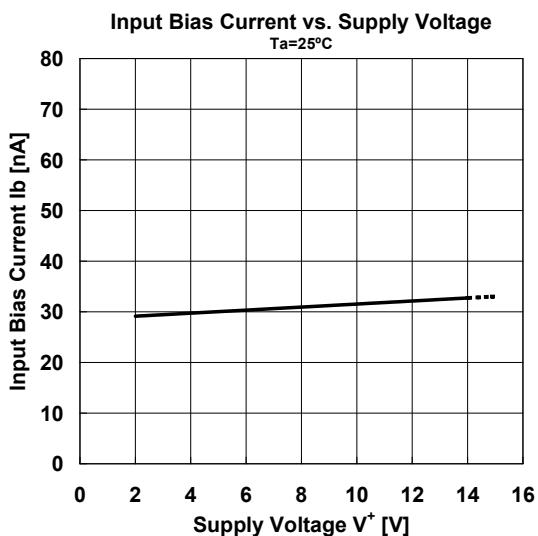

[CAUTION]  
 The specifications on this data book are only given for information, without any guarantee as regards either mistakes or omissions. The application circuits in this data book are described only to show representative usages of the product and not intended for the guarantee or permission of any right including the industrial rights.