

# TPS56339 4.5-V to 24-V Input, 3-A Output Synchronous Buck Converter

## 1 Features

- Input voltage range: 4.5 V to 24 V
- Output voltage range: 0.8 V to 16 V
- 3-A maximum continuous output current
- Fixed 500-kHz switching frequency
- Support up to 97% duty cycle
- Integrated 70-m $\Omega$  and 35-m $\Omega$  MOSFETs
- Typical 3- $\mu$ A shutdown current
- Typical 98- $\mu$ A quiescent current
- Internal 5-ms soft-start
- Internal loop compensation for ease use
- Cycle-by-cycle current limit for both high-side and low-side MOSFETs
- Non-latched UVP, UVLO and TSD protections
- SOT-23 (6) package
- Create a custom design using TPS56339 with the [WEBENCH® Power Designer](#)

## 2 Applications

- 12-V, 19-V distributed power-bus supply
- Industrial applications
  - Video surveillance and security systems
  - Appliance
- Consumer application
  - Digital TV and LCD monitors
  - Wireless and intelligent speakers

### Simplified Schematic

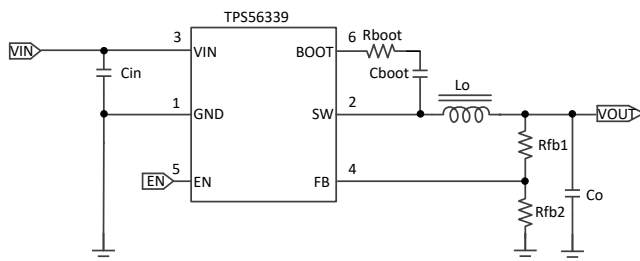

## 3 Description

The TPS56339 is a 4.5-V to 24-V input voltage range, 3-A synchronous buck converter. The device includes two integrated switching MOSFETs, internal loop compensation and 5-ms internal soft-start to reduce component count. By employing the SOT-23 (6) package, the device achieves the high power density and offers small footprint on PCB.

The TPS56339 employs Advanced Emulated Current Mode (AECM) control that can get fast transient response with fixed frequency. The internal adaptive loop adjustment eliminates the need for external compensation over a wide voltage output range.

Cycle-by-cycle current limit on the high-side protects the device in current overload conditions and is enhanced by a low-side sourcing current limit which prevents current runaway. Hiccup protection will be triggered under undervoltage and thermal shutdown protections.

### Device Information<sup>(1)</sup>

PART NUMBER	PACKAGE	BODY SIZE (NOM)
TPS56339	SOT-23 (6)	1.60 mm x 2.90 mm

(1) For all available packages, see the orderable addendum at the end of the data sheet.

### TPS56339 Efficiency

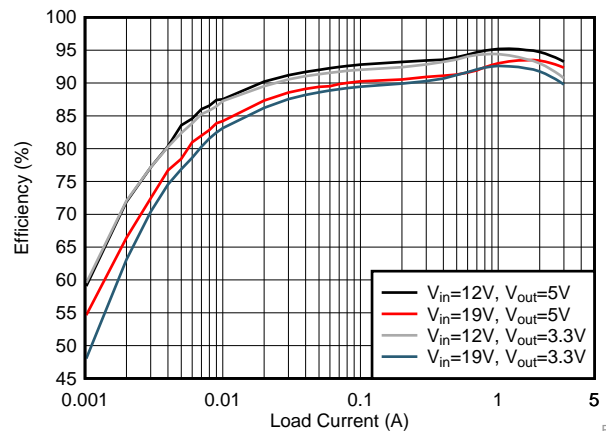

Eff-



## Table of Contents

<b>1 Features</b> .....	1	7.4 Device Functional Modes .....	14
<b>2 Applications</b> .....	1	7.5 Light-Load Operation .....	14
<b>3 Description</b> .....	1	<b>8 Application and Implementation</b> .....	15
<b>4 Revision History</b> .....	2	8.1 Application Information .....	15
<b>5 Pin Configuration and Functions</b> .....	3	8.2 Typical Application .....	15
<b>6 Specifications</b> .....	4	<b>9 Power Supply Recommendations</b> .....	21
6.1 Absolute Maximum Ratings .....	4	<b>10 Layout</b> .....	22
6.2 ESD Ratings .....	4	10.1 Layout Guidelines .....	22
6.3 Recommended Operating Conditions .....	4	10.2 Layout Example .....	22
6.4 Thermal Information .....	4	<b>11 Device and Documentation Support</b> .....	24
6.5 Electrical Characteristics .....	5	11.1 Receiving Notification of Documentation Updates .....	24
6.6 Timing Requirements .....	5	11.2 Related Links .....	24
6.7 Typical Characteristics .....	6	11.3 Community Resources .....	24
<b>7 Detailed Description</b> .....	9	11.4 Trademarks .....	24
7.1 Overview .....	9	11.5 Electrostatic Discharge Caution .....	24
7.2 Functional Block Diagram .....	10	11.6 Glossary .....	24
7.3 Feature Description .....	11	<b>12 Mechanical, Packaging, and Orderable Information</b> .....	24

## 4 Revision History

NOTE: Page numbers for previous revisions may differ from page numbers in the current version.

Changes from Original (November 2018) to Revision A	Page
• Changed marketing status from Advance Information to initial release. ....	1

## 5 Pin Configuration and Functions

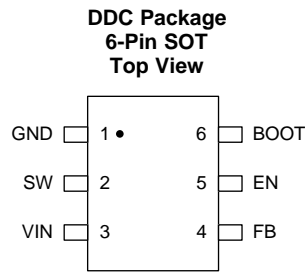

### Pin Functions

PIN		I/O <sup>(1)</sup>	DESCRIPTION
NAME	NO.		
BOOT	6	O	A 30-Ω boot resistor and a 0.1-μF bootstrap cap are required between BOOT and SW. The voltage on this cap carries the gate drive voltage for the high-side MOSFET.
EN	5	I	Enable pin. Float to enable. Adjust the input undervoltage lockout with two resistors.
FB	4	I	Converter feedback input. Connect to output voltage with feedback resistor divider.
GND	1	G	Ground pin. Source terminal of low-side MOSFET as well as the ground terminal for controller circuit. Connect sensitive FB to this GND at a single point.
SW	2	O	Switch node connection between high-side MOSFET and low-side MOSFET.
VIN	3	I	Input voltage supply pin. The drain terminal of high-side MOSFET.

(1) I = Input, O = Output, G = GND

## 6 Specifications

### 6.1 Absolute Maximum Ratings

Over the recommended operating junction temperature range of  $-40^{\circ}\text{C}$  to  $+125^{\circ}\text{C}$  (unless otherwise noted)<sup>(1)</sup>

		MIN	MAX	UNIT
Input voltages	V <sub>IN</sub>	-0.3	26	V
	EN	-0.3	6	
	BOOT	-0.3	SW+6	
	FB	-0.3	6	
Output voltages	BOOT-SW	-0.3	6	V
	SW	-0.3	26	
	SW (<10 ns transient)	-3	26	
T <sub>J</sub>	Operating junction temperature <sup>(2)</sup>	-40	150	°C
T <sub>stg</sub>	Storage temperature	-65	150	°C

- (1) Stresses beyond those listed under [Absolute Maximum Ratings](#) may cause permanent damage to the device. These are stress ratings only, which do not imply functional operation of the device at these or any other conditions beyond those indicated under Recommended Operating Conditions. Exposure to absolute-maximum-rated conditions for extended periods may affect device reliability.
- (2) Operating at junction temperatures greater than  $125^{\circ}\text{C}$ , although possible, degrades the lifetime of the device.

### 6.2 ESD Ratings

			VALUE	UNIT
V <sub>(ESD)</sub>	Electrostatic discharge	Human body model (HBM), per ANSI/ESDA/JEDEC JS-001, all pins <sup>(1)</sup>	±2000	V
		Charged device model (CDM), per JEDEC specification JESD22-C101, all pins <sup>(2)</sup>	±500	

- (1) JEDEC document JEP155 states that 500-V HBM allows safe manufacturing with a standard ESD control process.
- (2) JEDEC document JEP157 states that 250-V CDM allows safe manufacturing with a standard ESD control process.

### 6.3 Recommended Operating Conditions

Over the recommended operating junction temperature range of  $-40^{\circ}\text{C}$  to  $+125^{\circ}\text{C}$  (unless otherwise noted)<sup>(1)</sup>

		MIN	NOM	MAX	UNIT
Input voltage	V <sub>IN</sub>	4.5		24	V
	EN	-0.1		5.5	V
	FB	-0.1		5.5	V
Output voltage	BOOT-SW	-0.1		5.5	V
	SW	-0.1		24	V
Output Current	I <sub>OUT</sub>	0		3	A
Temperature	Operating junction temperature, T <sub>J</sub>	-40		125	°C

- (1) Conditions for which the device is intended to be functional, but do not ensure specific performance limits.

### 6.4 Thermal Information

THERMAL METRIC <sup>(1)</sup>		TPS56339	UNIT
		DDC (SOT23)	
		6 PINS	
R <sub>θJA</sub> <sup>(2)(3)</sup>	Junction-to-ambient thermal resistance	119.1	°C/W
R <sub>θJC(top)</sub>	Junction-to-case (top) thermal resistance	58.1	°C/W
R <sub>θJB</sub>	Junction-to-board thermal resistance	36.7	°C/W

- (1) For more information about traditional and new thermal metrics, see the Semiconductor and IC Package Thermal Metrics application report, [SPRA953](#)
- (2) The value of R<sub>θJA</sub> given in this table is only valid for comparison with other packages and can not be used for design purposes. These values were simulated on a standard JEDEC board. They do not represent the performance obtained in an actual application.
- (3) The real R<sub>θJA</sub> on TPS56339EVM is about 62.4 °C/W, test condition: V<sub>IN</sub> = 19 V, V<sub>OUT</sub> = 5 V, I<sub>OUT</sub> = 3 A, T<sub>A</sub> = 25 °C.

## Thermal Information (continued)

THERMAL METRIC <sup>(1)</sup>		TPS56339	UNIT
		DDC (SOT23)	
		6 PINS	
$\Psi_{JT}$	Junction-to-top characterization parameter	9.4	°C/W
$\Psi_{JB}$	Junction-to-board characterization parameter	36.2	°C/W

## 6.5 Electrical Characteristics

Limits apply over the recommended operating junction temperature ( $T_J$ ) range of  $-40^{\circ}\text{C}$  to  $+125^{\circ}\text{C}$ , unless otherwise stated. Minimum and maximum limits are specified through test, design or statistical correlation. Typical values represent the most likely parametric norm at  $T_J = 25^{\circ}\text{C}$ , and are provided for reference purposes only. Unless otherwise stated, the following conditions apply:  $V_{IN} = 4.5\text{ V}$  to  $24\text{ V}$ .

PARAMETER		TEST CONDITIONS	MIN	TYP	MAX	UNIT
<b>POWER SUPPLY (VIN PIN)</b>						
$V_{IN}$	Operation input voltage		4.5		24	V
$I_Q$	Non switching quiescent current	First power on with no load, then force $V_{FB}$ to 1.2 V, $V_{IN} = 12\text{ V}$		98		$\mu\text{A}$
$I_{SHDN}$	Shutdown supply current	$V_{IN} = 12\text{ V}$ , $V_{EN} = 0\text{ V}$		3		$\mu\text{A}$
$V_{IN\_UVLO}$	Undervoltage lockout thresholds	VIN Rising threshold	3.9	4.2	4.4	V
$V_{IN\_UVLO}$		VIN Falling threshold	3.5	3.7	3.9	V
<b>ENABLE (EN PIN)</b>						
$V_{EN\_RISE}$	Enable threshold	EN rising threshold		1.18	1.28	V
$V_{EN\_FALL}$		EN falling threshold	1.08	1.12		V
$I_{EN\_INPUT}$	Input current	$V_{EN} = 1.0\text{ V}$		1.2		$\mu\text{A}$
$I_{EN\_HYS}$	Hysteresis current	$V_{EN} = 1.5\text{ V}$		3.1		$\mu\text{A}$
<b>VOLTAGE REFERENCE (FB PIN)</b>						
$V_{REF}$	Reference voltage	$T_J = 25^{\circ}\text{C}$	0.790	0.802	0.814	V
		$T_J = -40^{\circ}\text{C}$ to $125^{\circ}\text{C}$	0.782	0.802	0.822	V
<b>INTEGRATED MOSFETS</b>						
$R_{DS\_ON\_HS}$	High-side MOSFET On-resistance	$T_J = 25^{\circ}\text{C}$ , $V_{BOOT-SW} = 5\text{ V}$		70		$\text{m}\Omega$
$R_{DS\_ON\_LS}$	Low-side MOSFET On-resistance	$T_J = 25^{\circ}\text{C}$ , $V_{IN} = 12\text{ V}$		35		$\text{m}\Omega$
<b>CURRENT LIMIT</b>						
$I_{HS\_LIMIT}$	High-side MOSFET current limit		3.9	4.7	5.4	A
$I_{LS\_LIMIT}$	Low-side MOSFET current limit	$V_{IN} = 12\text{ V}$	2.7	3.6	4.7	A
<b>OUTPUT UNDERVOLTAGE PROTECTION</b>						
$V_{UVP\_HYS}$	Output UVP threshold	Hiccup detect (H→L)		62.5		%
	Hysteresis			5		%
<b>BOOT UVLO</b>						
$V_{BOOT-SW}$	BOOT UVLO threshold			2.2		V
<b>OSCILLATOR</b>						
$f_{SW}$	Switching frequency		420	500	600	KHz
<b>THERMAL SHUTDOWN</b>						
$T_{SHDN}^{(1)}$	Thermal shutdown threshold			160		°C
$T_{HYS}^{(1)}$	Hysteresis			20		°C

(1) Not production tested

## 6.6 Timing Requirements

Limits apply over the recommended operating junction temperature ( $T_J$ ) range of  $-40^{\circ}\text{C}$  to  $+125^{\circ}\text{C}$ , unless otherwise stated. Minimum and maximum limits are specified through test, design or statistical correlation. Typical values represent the most likely parametric norm at  $T_J = 25^{\circ}\text{C}$ , and are provided for reference purposes only. Unless otherwise stated, the following

### Timing Requirements (continued)

Limits apply over the recommended operating junction temperature ( $T_J$ ) range of  $-40^{\circ}\text{C}$  to  $+125^{\circ}\text{C}$ , unless otherwise stated. Minimum and maximum limits are specified through test, design or statistical correlation. Typical values represent the most likely parametric norm at  $T_J = 25^{\circ}\text{C}$ , and are provided for reference purposes only. Unless otherwise stated, the following conditions apply:  $V_{IN} = 4.5\text{ V}$  to  $24\text{ V}$ .

conditions apply:  $V_{IN} = 4.5\text{ V}$  to  $24\text{ V}$ .

PARAMETER		TEST CONDITIONS	MIN	TYP	MAX	UNIT
<b>ON TIMER CONTROL</b>						
$T_{ON\_MIN}^{(1)}$	Minimum on time			55		ns
$T_{ON\_MAX}$	Maximum on time			5		$\mu\text{s}$
$T_{OFF\_MIN}$	Minimum off time			115		ns
<b>SOFT START</b>						
$T_{SS}$	Internal soft-start time			5		ms
<b>OUTPUT UNDERVOLTAGE PROTECTION</b>						
$T_{HIC\_WAIT}$	Hiccup on time			120		$\mu\text{s}$
$T_{HIC\_RE}$	Hiccup time before restart			38		ms

(1) Not production tested

### 6.7 Typical Characteristics

$V_{IN} = 12\text{ V}$  (unless otherwise noted)

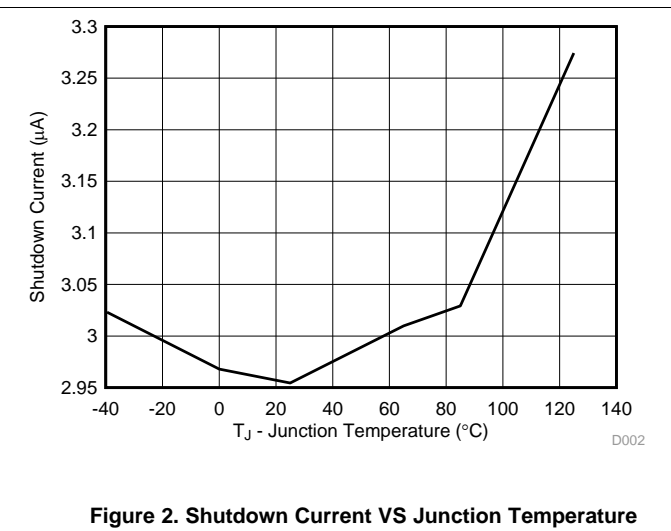
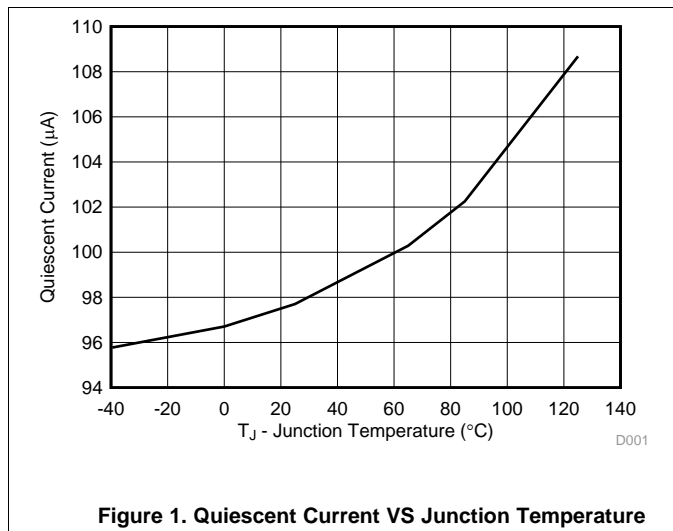

Typical Characteristics (continued)

V<sub>IN</sub> = 12 V (unless otherwise noted)

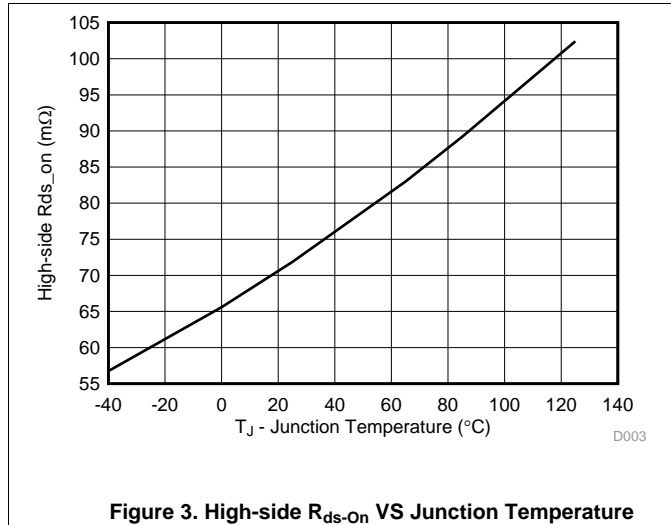

Figure 3. High-side R<sub>ds-On</sub> VS Junction Temperature

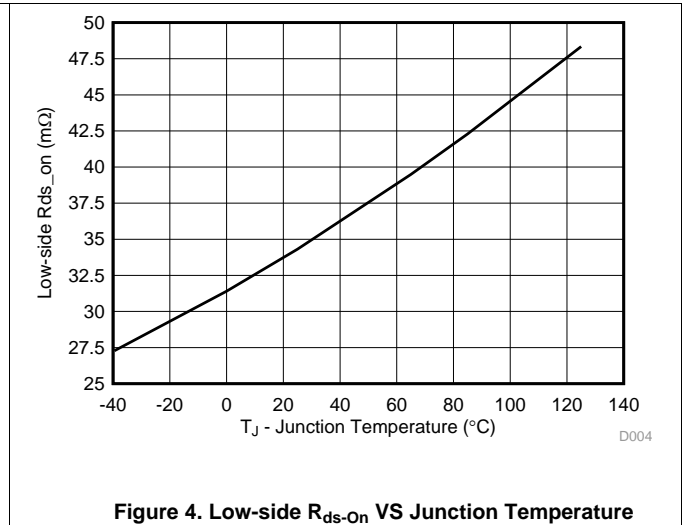

Figure 4. Low-side R<sub>ds-On</sub> VS Junction Temperature

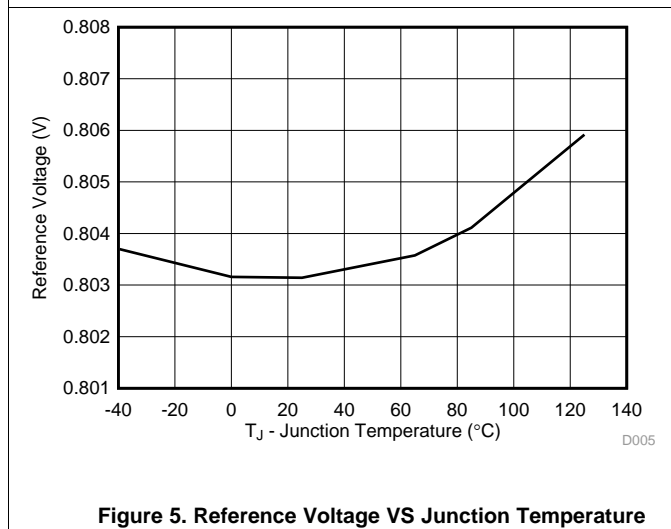

Figure 5. Reference Voltage VS Junction Temperature

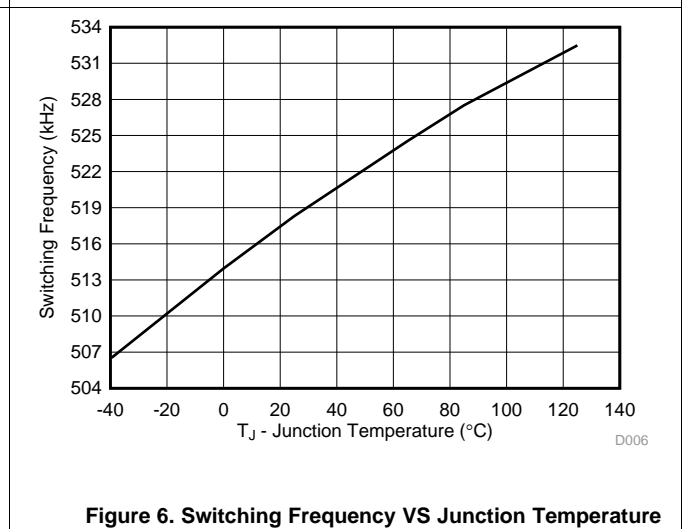

Figure 6. Switching Frequency VS Junction Temperature

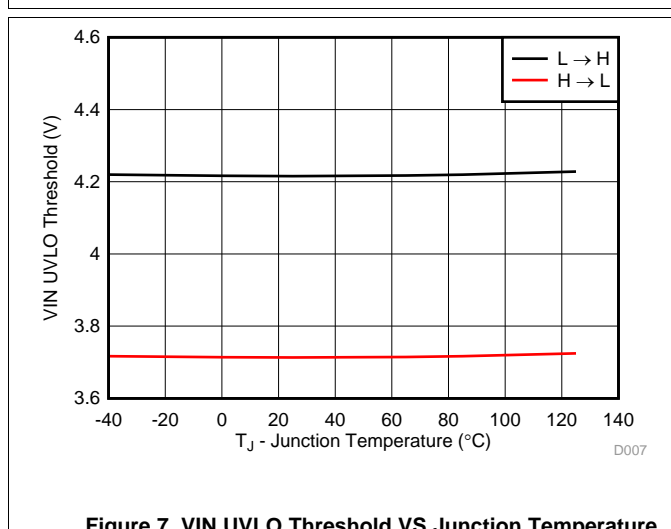

Figure 7. VIN UVLO Threshold VS Junction Temperature

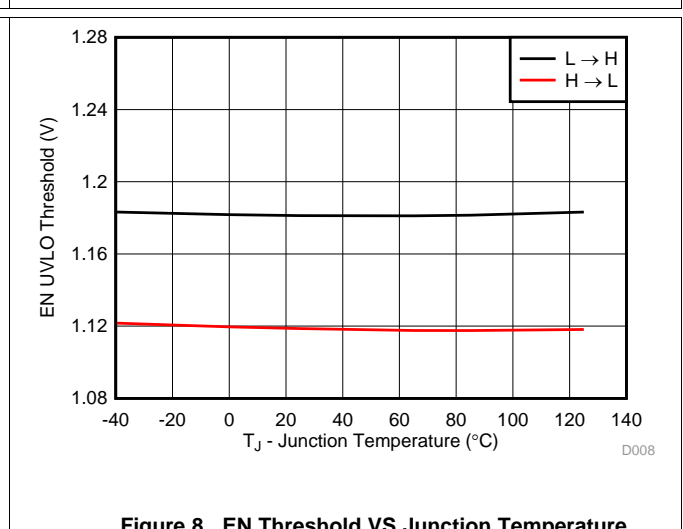

Figure 8. EN Threshold VS Junction Temperature

### Typical Characteristics (continued)

$V_{IN} = 12\text{ V}$  (unless otherwise noted)

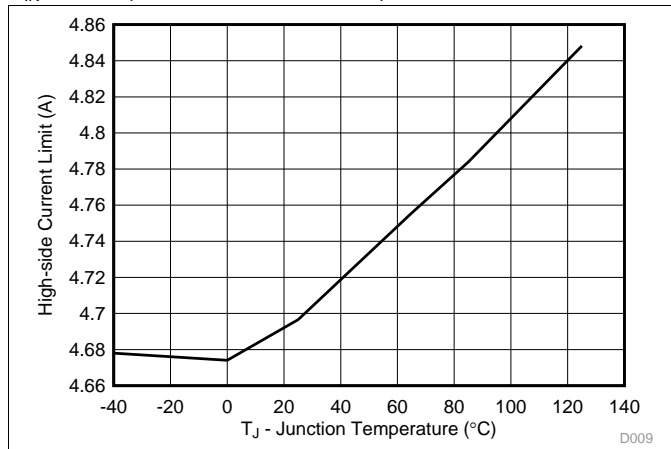

Figure 9. High-side Current Limit Threshold VS Junction Temperature

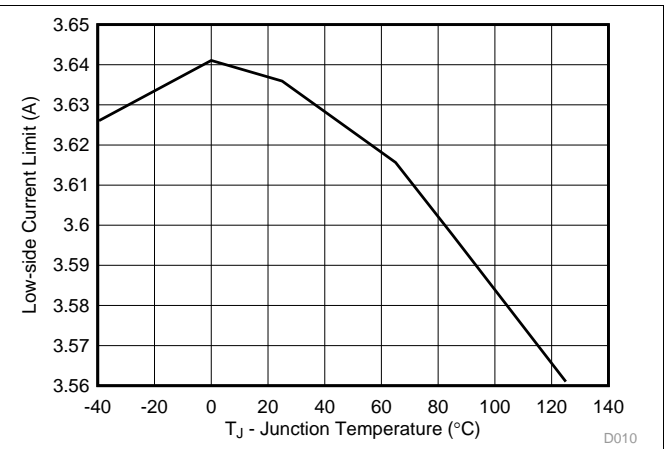

Figure 10. Low-side Current Limit Threshold VS Junction Temperature

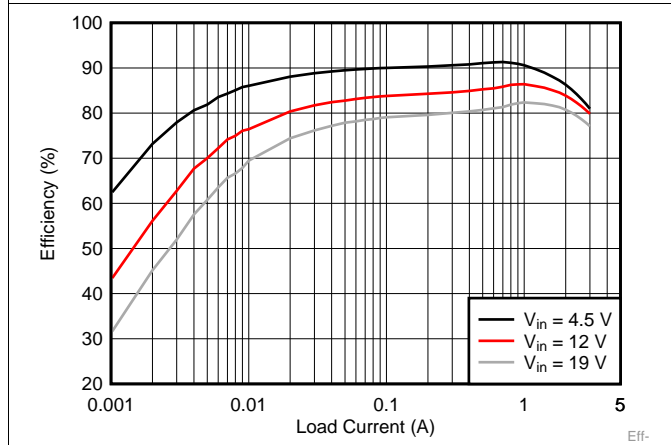

Figure 11.  $V_{OUT}=1.05\text{ V}$  Efficiency,  $L=1.5\ \mu\text{H}$

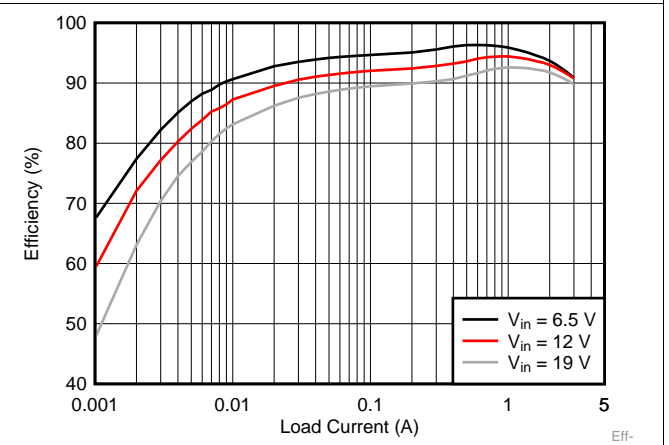

Figure 12.  $V_{OUT}=3.3\text{ V}$  Efficiency,  $L=4.7\ \mu\text{H}$

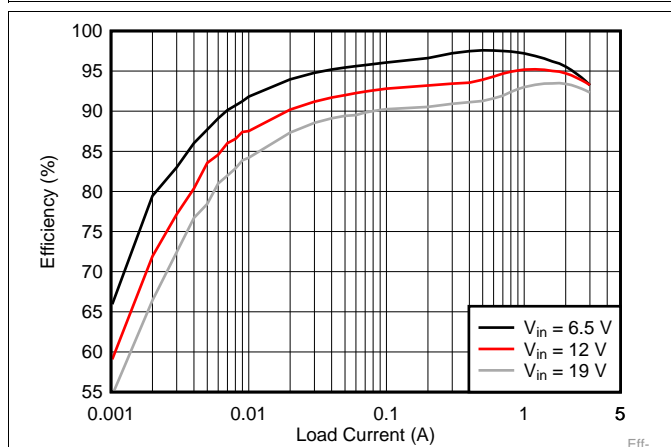

Figure 13.  $V_{OUT}=5\text{ V}$  Efficiency,  $L=5.6\ \mu\text{H}$

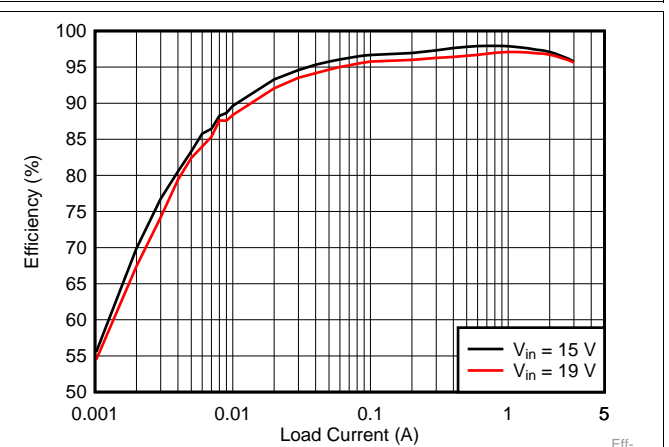

Figure 14.  $V_{OUT}=12\text{ V}$  Efficiency,  $L=6.8\ \mu\text{H}$



## 7 Detailed Description

### 7.1 Overview

The TPS56339 is a 24-V, 3-A, synchronous buck (step-down) converter with two integrated n-channel MOSFETs. The device implements an AECM control which can get fast transient response with fixed frequency. The fast transient response results in low voltage drop and the fixed frequency brings a better jitter permanence and predictable frequency for EMI design. The optimized internal compensation network minimizes the external component counts and simplifies the control loop design.

The TPS56339 is designed for safe monotonic start-up into pre-biased loads. The default start-up is when VIN is typically 4.5 V. The EN pin has an internal pull-up current source that can be used to adjust the input voltage undervoltage lockout (UVLO) with two external resistors. In addition, the EN pin can be floating for the device to operate with the internal pull-up current. The total operating current for the device is approximately 98  $\mu$ A when not switching and under no load. When the device is disabled, the supply current is approximately 3  $\mu$ A. The integrated 70-m $\Omega$  high-side MOSFET and 35-m $\Omega$  allow for high efficiency power supply designs with continuous output currents up to 3 A.

The TPS56339 reduces the external component count by integrating the boot recharge circuit. The bias voltage for the integrated high-side MOSFET is supplied by a capacitor between the BOOT and SW pins. The boot capacitor voltage is monitored by a BOOT to SW UVLO (BOOT-SW UVLO) circuit allowing SW pin to be pulled low to recharge the boot capacitor. The device has a on-time extension function with a maximum on time of 5  $\mu$ s to keep the boot capacitor voltage higher than the preset BOOT-SW UVLO threshold which is typically 2.2 V. During low dropout operation, large duty cycle is needed. The high-side MOSFET could turn on up to 5  $\mu$ s. Then the high-side MOSFET turns off and the low-side MOSFET turns on with a minimum off time of 115 ns, supporting a maximum duty cycle of 97%.

The TPS56339 integrates output undervoltage protection. When the regulated output voltage is lower than 62.5% of the nominal voltage due to over current triggered, the undervoltage comparator is activated. 120  $\mu$ s deglitch timer later, both the high-side and low-side MOSFET turn off, the device steps into hiccup mode.

The TPS56339 has internal 5-ms soft-start time to minimize inrush currents.

## 7.2 Functional Block Diagram

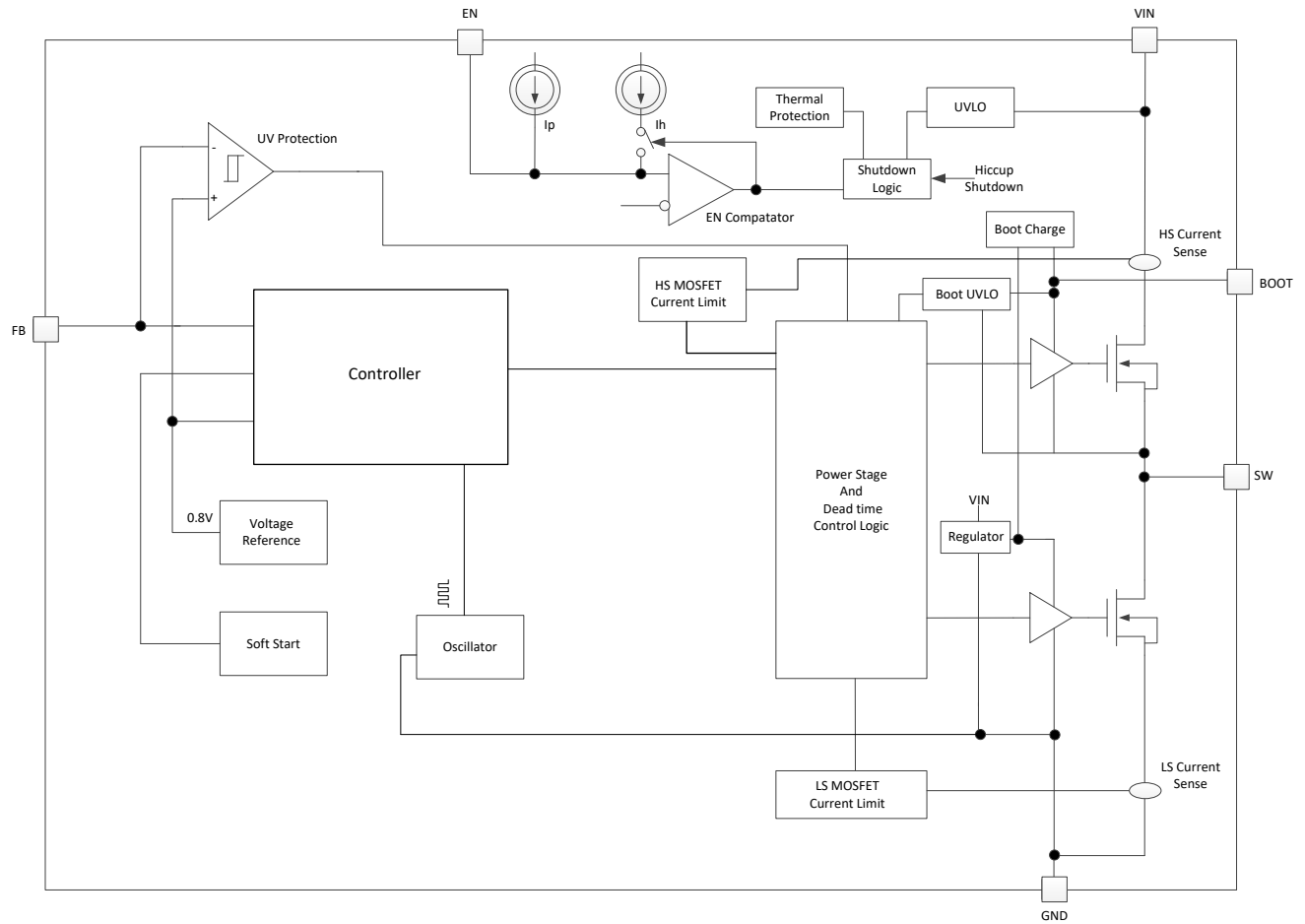

## 7.3 Feature Description

### 7.3.1 Advanced Emulated Current Mode Control

The TPS56339 uses an Advanced Emulated Current Mode (AECM) control, which is an emulated current control topology. The TPS56339 uses an internal oscillator to generate clock to trigger high-side MOSFET turn on. Once the emulated inductor current ramp up trigger internal reference, the high-side MOSFET turns off and the low-side MOSFET turns on. Until the next clock coming, the low-side MOSFET turns off and the high-side MOSFET turns on again. The switching frequency is controlled by the oscillator clock and is fixed that provides ease of filter design to overcome EMI noise. The internal adaptive loop adjustment eliminates the need for external compensation over a wide voltage output range up to 16V. However, dynamic adjustment output voltage is not supported.

### 7.3.2 Enable and Adjusting Undervoltage Lockout

The EN pin provides electrical on and off control of the device. When the EN pin voltage exceeds the threshold voltage, the TPS56339 begins operation. If the EN pin voltage is pulled below the threshold voltage, the regulator stops switching and enters the shutdown mode.

The EN pin has an internal pull-up current source which allows the user to float the EN pin to enable the device. If an application requires control of the EN pin, use open-drain or open-collector output logic to interface with the pin.

The TPS56339 implements internal undervoltage-lockout (UVLO) circuitry on the VIN pin. The device is disabled when the VIN pin voltage falls below the internal VIN UVLO threshold. The internal VIN UVLO threshold has a hysteresis of 510 mV.

If an application requires a higher UVLO threshold on the VIN pin, the EN pin can be configured as shown in [Figure 15](#). When using the external UVLO function, setting the hysteresis at a value greater than 510 mV is recommended.

The EN pin has a small pull-up current,  $I_p$ , which sets the default state of the EN pin to enable when no external components are connected. The pull-up current is also used to control the voltage hysteresis for the UVLO function because it increases by  $I_h$  when the EN pin crosses the enable threshold. Use [Equation 1](#), and [Equation 2](#) to calculate the values of R1 and R2 for a specified UVLO threshold. Once R1, R2 were settled down, the  $V_{EN}$  voltage can be calculated by [Equation 3](#), which should be lower than 5.5V with max  $V_{IN}$ .

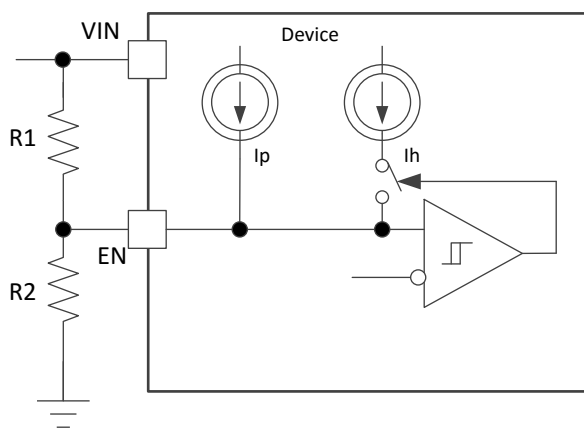

Figure 15. Adjustable VIN Undervoltage Lockout

$$R_1 = \frac{V_{SATART} \frac{V_{EN\_FALL}}{V_{EN\_RISE}} - V_{STOP}}{I_p \left( 1 - \frac{V_{EN\_FALL}}{V_{EN\_RISE}} \right) + I_h} \quad (1)$$

## Feature Description (continued)

$$R_2 = \frac{R_1 \cdot V_{EN\_FALL}}{V_{STOP} - V_{EN\_FALL} + R_1 \cdot (I_p + I_h)} \quad (2)$$

$$V_{EN} = \frac{R_2 \cdot V_{IN} + R_1 R_2 (I_p + I_h)}{R_1 + R_2}$$

where

- $I_p = 1.2 \mu\text{A}$
  - $I_h = 3.1 \mu\text{A}$
  - $V_{EN\_FALL} = 1.12 \text{ V}$
  - $V_{EN\_RISE} = 1.18 \text{ V}$
  - $V_{SATRT}$ , the input voltage enabling the device
  - $V_{STOP}$ , the input voltage disabling the device
- (3)

### 7.3.3 Soft Start and Pre-Biased Soft Start

The TPS56339 has an internal 5-ms soft-start. When the EN pin becomes high, the internal soft-start function begins ramping up the reference voltage to the PWM comparator.

The TPS56339 has been designed to prevent the low-side MOSFET from discharging a pre-biased output. During monotonic pre-biased startup, both high-side and low-side MOSFET are not allowed to be turned on until the internal soft-start voltage is higher than FB pin voltage. This scheme ensures that the converters ramp up smoothly into regulation point.

### 7.3.4 Voltage Reference

The voltage reference system produces a precise  $\pm 2.5\%$  voltage reference over full temperature by scaling the output of a temperature stable bandgap circuit. The typical voltage reference is designed at 0.802 V.

### 7.3.5 Minimum ON-time, Minimum OFF-time and Frequency Foldback at Dropout Conditions

Minimum ON-time,  $T_{ON\_MIN}$ , is the smallest duration of time that the high-side MOSFET can be on.  $T_{ON\_MIN}$  is typically 55ns in the TPS56339. Minimum OFF-time,  $T_{OFF\_MIN}$ , is the smallest duration that the high-side MOSFET can be off.  $T_{OFF\_MIN}$  is typically 115 ns in the TPS56339. In CCM operation,  $T_{ON\_MIN}$  and  $T_{OFF\_MIN}$  limit the voltage conversion range given a fixed switching frequency.

The minimum duty cycle allowed is:

$$D_{MIN} = T_{ON\_MIN} \times f_{SW} \quad (4)$$

And the maximum duty cycle allowed is:

$$D_{MAX} = 1 - T_{OFF\_MIN} \times f_{SW} \quad (5)$$

In the TPS56339, a frequency foldback scheme is employed to extend the maximum duty cycle when  $T_{OFF\_MIN}$  is reached. The switching frequency decreases once longer duty cycle is needed under low  $V_{IN}$  conditions. With the duty increase, the on time will increase, until up to the Maximum ON-time, 5  $\mu\text{s}$ . Wide range of frequency foldback allows the TPS56339 output voltage stay in regulation with a much lower supply voltage  $V_{IN}$ . This leads to a lower effective dropout voltage.

Given an output voltage, the maximum operation supply voltage can be found by:

$$V_{IN\_MAX} = \frac{V_{OUT}}{f_{SW} \cdot T_{ON\_MIN}} \quad (6)$$

At lower supply voltage, the switching frequency decreases once  $T_{OFF\_MIN}$  is triggered. The minimum  $V_{IN}$  without frequency foldback can be approximated by:

## Feature Description (continued)

$$V_{IN\_MIN} = \frac{V_{OUT}}{(1-f_{SW} \cdot T_{OFF\_MIN})} \quad (7)$$

Taking considerations of power losses in the system with heavy load operation,  $V_{IN\_MAX}$  is higher than the result calculated in Equation 6. With frequency foldback,  $V_{IN\_MIN}$  is lowered by decreased  $f_{SW}$ , as shown in Figure 16.

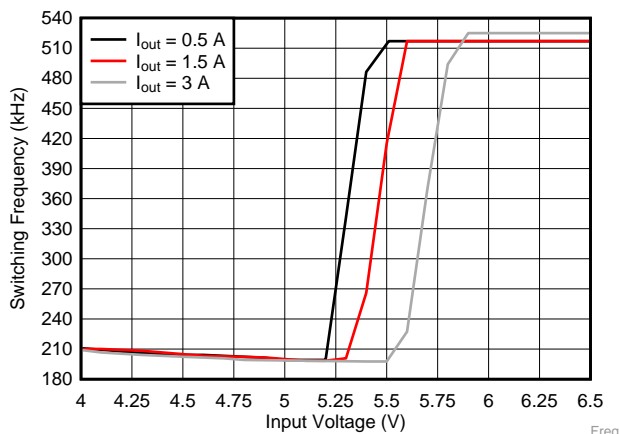

Figure 16. Frequency Foldback at Dropout ( $V_{OUT} = 5\text{ V}$ )

### 7.3.6 Overcurrent and Undervoltage Protection

The TPS56339 is protected from overcurrent conditions by cycle-by-cycle current limiting on both the peak and valley of the inductor current.

During the on time of the high-side MOSFET switch, the inductor current flow through high-side FET and increases at a linear rate determined by  $V_{IN}$ ,  $V_{OUT}$ , the on-time and the output inductor value. The high-side switch current is sensed when the high-side is turned on after a set blanking time and then compared with the high-side MOSFET current limit every switching cycle. If the cross-limit event detected after the minimum On-time, the high-side MOSFET is turned off immediately and the high-side MOSFET current is limited by a clamped maximum peak current threshold  $I_{HS\_LIMIT}$  which is constant.

The current going through low-side MOSFET is also sensed and monitored. When the low-side MOSFET turns on, the inductor current begins to ramp down. The low-side MOSFET is not turned OFF at the end of a switching cycle if its current is above the low-side current limit  $I_{LS\_LIMIT}$ . The low-side MOSFET is kept ON for the next cycle so that inductor current keeps ramping down, until the inductor current ramps below the low-side current limit  $I_{LS\_LIMIT}$  and the subsequent switching cycle comes, the low-side MOSFET is turned OFF, and the high-side MOSFET is turned on after a dead time.

There are some important considerations for this type of overcurrent protection. The load current is higher than the overcurrent threshold by one half of the peak-to-peak inductor ripple current. Also, when the current is being limited, the output voltage tends to fall as the demanded load current may be higher than the current available from the converter. When the  $V_{FB}$  voltage falls below the UVP threshold voltage, the UVP comparator detects it. The device will shut down after the UVP delay time (typically 120  $\mu\text{s}$ ) and re-start after the hiccup time (typically 38 ms). The hiccup mode helps to reduce the device power dissipation under severe overcurrent conditions.

When the over current condition is removed, the output voltage returns to the regulated value.

### 7.3.7 Thermal Shutdown

The internal thermal shutdown circuitry forces the TPS56339 to stop switching if the junction temperature exceeds 160°C typically. The device reinitiates the power-up sequence when the junction temperature drops below 140°C typically.

## 7.4 Device Functional Modes

### 7.4.1 Shutdown Mode

The EN pin provides electrical ON and OFF control for the device. When  $V_{EN}$  is below 1.12 V (typical), the TPS56339 is in shutdown mode with a shutdown current of 3  $\mu$ A (typical). The device also employs VIN UVLO protection. If VIN voltage is below their respective UVLO level, the regulator is turned off.

### 7.4.2 Active Mode

The TP56339 is in active mode when  $V_{EN}$  is above the precision enable threshold,  $V_{IN}$  is above its respective UVLO level. The simplest way to enable the device is to float the EN pin. This allows self startup when the input voltage is in the operating range 4.5 V to 24 V.

In active mode, depending on the load current, the device is in one of three modes:

1. Continuous Conduction Mode (CCM) with fixed switching frequency when load current is above half of the peak-to-peak inductor current ripple.
2. Discontinuous Conduction Mode (DCM) with fixed switching frequency when load current is lower than half of the peak-to-peak inductor current ripple in CCM operation.
3. Pulse Frequency Modulation Mode (PFM) when switching frequency is decreased at very light load.

### 7.4.3 CCM Operation

CCM operation is employed in the TPS56339 when the load current is higher than half of the peak-to-peak inductor current. In CCM operation, the frequency of operation is fixed, output voltage ripple is at a minimum in this mode, and the maximum continuous output current of 3 A can be supplied by the TPS56339.

## 7.5 Light-Load Operation

The light load running includes Discontinuous Conduction Mode (DCM) and Pulse Frequency Modulation Mode (PFM).

As the output current decreases from heavy load condition, the inductor current is also reduced and eventually comes to point that its rippled valley touches zero level, which is the boundary between CCM and DCM. The low-side MOSFET is turned off when the zero inductor current is detected. As the load current further decreases, the converter runs into DCM.

At even lighter current loads, PFM is activated to maintain high efficiency operation. The On-time is kept almost the same as it was in the CCM so that it takes longer time to discharge the output capacitor with smaller load current to the level of the reference voltage. This makes the switching frequency lower, proportional to the load current, and keeps the light load efficiency high. The transition point to the light load operation  $I_{OUT(LL)}$  current can be calculated in [Equation 8](#).

$$I_{OUT(LL)} = \frac{0.75^2}{2 \cdot L_1 \cdot f_{sw}} \cdot \frac{(V_{IN} - V_{OUT}) \cdot V_{OUT}}{V_{IN}} \quad (8)$$

## 8 Application and Implementation

### NOTE

Information in the following applications sections is not part of the TI component specification, and TI does not warrant its accuracy or completeness. TI's customers are responsible for determining suitability of components for their purposes. Customers should validate and test their design implementation to confirm system functionality.

### 8.1 Application Information

The TPS56339 is a highly-integrated, synchronous, step-down, DC-DC converter. This device is used to convert a higher DC input voltage to a lower DC output voltage, with a maximum output current of 3 A.

### 8.2 Typical Application

The application schematic of Figure 17 was developed to meet the requirements of the device. This circuit is available as the TPS56339EVM evaluation module. The design procedure is given in this section.

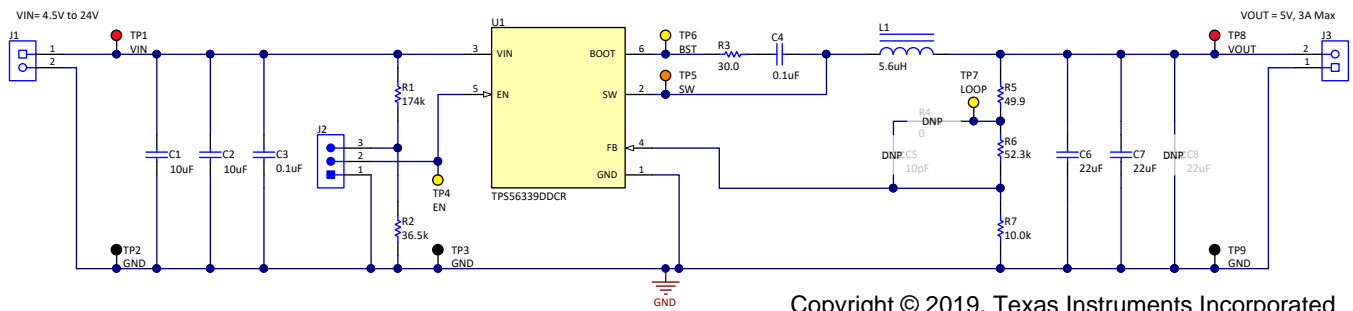

Copyright © 2019, Texas Instruments Incorporated

Figure 17. TPS56339 5-V, 3-A Reference Design

#### 8.2.1 Design Requirements

Table 1 shows the design parameters for this application.

Table 1. Design Parameters

PARAMETER	EXAMPLE VALUE
Input voltage	12 V nominal, 5.5 V to 24 V
Output voltage	5 V
Output current rating	3 A
Transient response, 2A load step	$\Delta V_{OUT} / V_{OUT} = \pm 5\%$
Output ripple voltage	30 mV
Input ripple voltage	300 mV
Start Input Voltage (Rising Vin)	6.6 V
Stop Input Voltage (Falling Vin)	5.7 V
Operating frequency	500 kHz

#### 8.2.2 Detailed Design Procedure

##### 8.2.2.1 Custom Design With WEBENCH® Tools

Click [here](#) to create a custom design using the TPS56339 device with the WEBENCH® Power Designer.

1. Start by entering the input voltage ( $V_{IN}$ ), output voltage ( $V_{OUT}$ ), and output current ( $I_{OUT}$ ) requirements.
2. Optimize the design for key parameters such as efficiency, footprint, and cost using the optimizer dial.
3. Compare the generated design with other possible solutions from Texas Instruments.

The WEBENCH Power Designer provides a customized schematic along with a list of materials with real-time pricing and component availability.

In most cases, these actions are available:

- Run electrical simulations to see important waveforms and circuit performance
- Run thermal simulations to understand board thermal performance
- Export customized schematic and layout into popular CAD formats
- Print PDF reports for the design, and share the design with colleagues

Get more information about WEBENCH tools at [www.ti.com/WEBENCH](http://www.ti.com/WEBENCH).

### 8.2.2.2 Output Voltage Resistors Selection

The output voltage is set with a resistor divider from the output node to the FB pin. TI recommends using 1% tolerance or better divider resistors. Referring to the application schematic of [Figure 17](#), start with a 10 kΩ for R7 and use [Equation 9](#) to calculate R6. To improve efficiency at light loads consider using larger value resistors. If the values are too high the regulator is more susceptible to noise and voltage errors from the FB input current are noticeable.

$$R_6 = \frac{V_{OUT} - V_{REF}}{V_{REF}} \cdot R_7 \quad (9)$$

[Table 2](#) shows the recommended components value for common output voltages.

### 8.2.2.3 Output Inductor Selection

To calculate the value of the output inductor, use [Equation 10](#).  $K_{IND}$  is a coefficient that represents the amount of inductor ripple current relative to the maximum output current. The inductor ripple current is filtered by the output capacitor. Therefore, choosing high inductor ripple currents impact the selection of the output capacitor because the output capacitor must have a ripple current rating equal to or greater than the inductor ripple current. In general, the inductor ripple value is at the discretion of the designer. For this part, TI recommends the range of  $K_{IND}$  from 30% to 50%.

$$L_{MIN} = \frac{V_{OUT}}{V_{IN\_MAX}} \cdot \frac{V_{IN\_MAX} - V_{OUT}}{K_{IND} \cdot I_{OUT} \cdot f_{SW}}$$

where

- $I_{OUT} = 3$  A, the rated output current of the device (10)

For this design example, use  $K_{IND} = 50\%$  and the inductor value is calculated to be 5.28 μH. For this design, a nearest standard value was chosen: 5.6 μH. For the output filter inductor, it is important that the RMS current and saturation current ratings not be exceeded. The inductor peak-to-peak ripple current, peak current and RMS current are calculated using [Equation 11](#), [Equation 12](#), and [Equation 13](#).

$$I_{RIPPLE} = \frac{V_{OUT}}{V_{IN\_MAX}} \cdot \frac{V_{IN\_MAX} - V_{OUT}}{L_1 \cdot f_{SW}} \quad (11)$$

$$I_{LPEAK} = I_{OUT} + \frac{I_{RIPPLE}}{2} \quad (12)$$

$$I_{LRMS} = \sqrt{I_{OUT}^2 + \frac{1}{12} I_{RIPPLE}^2} \quad (13)$$

For this design example, the calculated peak current is 4 A and the calculated RMS current is 3.03 A. The chosen inductor is a Vishay-Dale IHLP3232DZER5R6M11 5.6-μH. It has a saturation current rating of 7.6 A and a RMS current rating of 7.4 A.



The current flowing through the inductor is the inductor ripple current plus the output current. During power up, faults or transient load conditions, the inductor current can increase above the calculated peak inductor current level calculated above. In transient conditions, the inductor current can increase up to the switch current limit of the device. For this reason, the most conservative approach is to specify an inductor with a saturation current rating equal to or greater than the switch current limit rather than the peak inductor current.

### 8.2.2.4 Output Capacitor Selection

After selecting the inductor, the output capacitor needs to be optimized. The LC filter used as the output filter has double pole at:

$$f_p = \frac{1}{2\pi\sqrt{L_1 \cdot C_{OUT\_E}}} \quad (14)$$

At low frequencies, the overall loop gain is set by the output set-point resistor divider network and the internal gain of the device. The low frequency phase is 180°. At the output filter pole frequency, the gain rolls off at a –40 dB per decade rate and the phase drops rapidly. A high frequency zero introduced by internal circuit that reduces the gain roll off to –20 dB per decade and increases the phase to 90° one decade above the zero frequency. The inductor and capacitor for the output filter must be selected so that the double pole of Equation 14 is located below the high frequency zero but close enough that the phase boost provided by the high frequency zero provides adequate phase margin for a stable circuit. To meet this requirement, make sure that the  $L_1 \cdot C_{OUT\_E}$  value meets the range of  $L_1 \cdot C_{OUT\_E}$  value recommended in Table 2.

**Table 2. Recommended Component Values**

OUTPUT VOLTAGE <sup>(1)</sup> (V)	R6 <sup>(2)</sup> (kΩ)	R7 (kΩ)	L1 <sup>(3)</sup> (μH)	C <sub>OUT</sub> <sup>(4)</sup> (μF)	Range of L1·C <sub>OUT_E</sub> <sup>(5)</sup> (μH×μF)
1.05	3.16	10.0	1.5	2×22	48 to 188
1.8	12.4	10.0	2.2	2×22	64 to 250
2.5	21.5	10.0	3.3	2×22	87 to 334
3.3	31.6	10.0	4.7	2×22	107 to 404
5	52.3	10.0	5.6	2×22	93 to 334
12	140	10.0	6.8	3×22	45 to 137

- (1) Please use the recommended L1 and C<sub>OUT</sub> combination of the higher and closest output rail for the unlisted output rails.
- (2) R6 = 0 Ω for V<sub>OUT</sub> = 0.8 V.
- (3) Inductance values are calculated based on V<sub>IN</sub>=19V, but they can also be used for other input voltages. Users can calculate their preferred inductance value per Equation 10.
- (4) The C<sub>OUT</sub> is the sum of nominal output capacitance. Two 22-μF, 0805, 16V capacitors are recommended for V<sub>OUT</sub> ≤ 5V, three 22-μF, 0805, 25VDC capacitors are recommended for V<sub>OUT</sub> > 5V.
- (5) The C<sub>OUT\_E</sub> is the effective value after derating, the value of L1·C<sub>OUT\_E</sub> should be within in the range.

The capacitor value and ESR determines the amount of output voltage ripple. The TPS56339 is intended for use with ceramic or other low ESR capacitors. Use Equation 15 to determine the required RMS current rating for the output capacitor.

$$I_{CORMS} = \frac{V_{OUT} \cdot (V_{IN\_MAX} - V_{OUT})}{\sqrt{12} \cdot V_{IN\_MAX} \cdot L_1 \cdot f_{SW}} \quad (15)$$

For this design two Murata GRM21BR61C226ME44 22-μF, 0805, 16-V output capacitors are used. From the data sheet the estimated DC derating of 51.8% at room temperature with AC voltage of 0.2V. The total output effective capacitance is approximately 22.8 μF. The value of L1·C<sub>OUT\_E</sub> is 127.7 μH×μF, which is within the recommended range.

### 8.2.2.5 Input Capacitor Selection

The TPS56339 requires an input decoupling capacitor and a bulk capacitor is needed depending on the application. TI recommends a ceramic capacitor over 10  $\mu\text{F}$  for the decoupling capacitor. An additional 0.1- $\mu\text{F}$  capacitor (C3) from VIN pin to ground is recommended to provide additional high frequency filtering. The capacitor voltage rating needs to be greater than the maximum input voltage. The capacitor must also have a ripple current rating greater than the maximum input current ripple of the TPS56339. The input ripple current can be calculated using [Equation 16](#).

$$I_{\text{CIRMS}} = I_{\text{OUT}} \cdot \sqrt{\frac{V_{\text{OUT}}}{V_{\text{IN\_MIN}}} \cdot \frac{V_{\text{IN\_MIN}} - V_{\text{OUT}}}{V_{\text{IN\_MIN}}}} \quad (16)$$

The value of a ceramic capacitor varies significantly over temperature and the amount of DC bias applied to the capacitor. The capacitance variations due to temperature can be minimized by selecting a dielectric material that is stable over temperature. X5R and X7R ceramic dielectrics are usually selected for power regulator capacitors because they have a high capacitance to volume ratio and are fairly stable over temperature. The output capacitor must also be selected with the DC bias taken into account. The capacitance value of a capacitor decreases as the DC bias across a capacitor increases. For this example design, a ceramic capacitor with at least a 35-V voltage rating is required to support the maximum input voltage. For this example, two Murata GRM21BR6YA106KE43L (10- $\mu\text{F}$ , 35-V, 0805, X5R) capacitors have been selected. The effective capacitance under input voltage of 12 V for each one is  $0.269 \times 10 = 2.69 \mu\text{F}$ . The input capacitance value determines the input ripple voltage of the regulator. The input voltage ripple can be calculated using [Equation 17](#). Using the design example values,  $I_{\text{OUT\_MAX}} = 3 \text{ A}$ ,  $C_{\text{IN\_E}} = 2 \times 2.69 = 5.38 \mu\text{F}$ ,  $f_{\text{SW}} = 500 \text{ kHz}$ , yields an input voltage ripple of 279 mV and a RMS input ripple current of 1.48 A.

$$\Delta V_{\text{IN}} = \frac{I_{\text{OUT\_MAX}} \cdot 0.25}{C_{\text{IN}} \cdot f_{\text{SW}}} + (I_{\text{OUT\_MAX}} \cdot R_{\text{ESR\_MAX}})$$

where

- $R_{\text{ESR\_MAX}}$  is the maximum series resistance of the input capacitor (17)

### 8.2.2.6 Bootstrap Capacitor Selection

A 0.1- $\mu\text{F}$  ceramic capacitor must be connected between the BOOT to SW pin for proper operation. TI recommends to use a ceramic capacitor with X5R or better grade dielectric. The capacitor must have a 10-V or higher voltage rating. In addition, TI recommends in series one boot resistor to make the device more robust, so a 30- $\Omega$  of R3 are required to be used between BOOT to bootstrap capacitor, C4.

### 8.2.3 Undervoltage Lockout Set Point

The undervoltage lockout (UVLO) can be adjusted using the external voltage divider network of R1 and R2. R1 is connected between VIN and the EN pin of the TPS56339 and R2 is connected between EN and GND. The UVLO has two thresholds, one for power up when the input voltage is rising and one for power down or brownouts when the input voltage is falling. For the example design, the supply should turn on and start switching when the input voltage increases above 6.6 V (UVLO start or enable). After the regulator starts switching, it should continue to do so until the input voltage falls below 5.7 V (UVLO stop or disable). [Equation 1](#) and [Equation 2](#) can be used to calculate the values for the upper and lower resistor values. For the stop voltages specified the nearest standard resistor value for R1 is 174 k $\Omega$  and for R2 is 36.5 k $\Omega$ .

### 8.2.4 Application Curves

$V_{IN} = 12\text{ V}$ ,  $L_1 = 5.6\ \mu\text{H}$ ,  $C_{OUT} = 44\ \mu\text{F}$ ,  $T_A = 25\ ^\circ\text{C}$ . (unless otherwise noted)

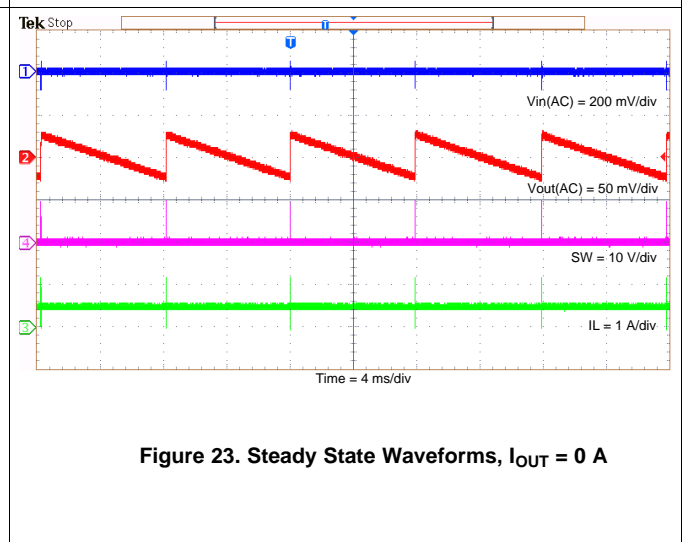
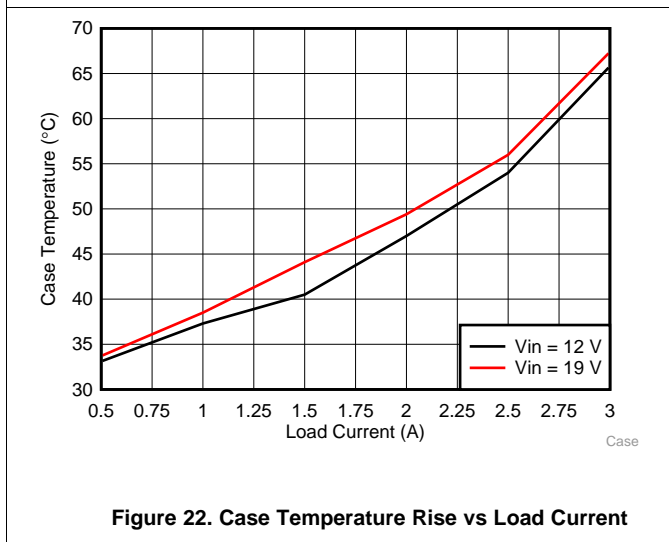
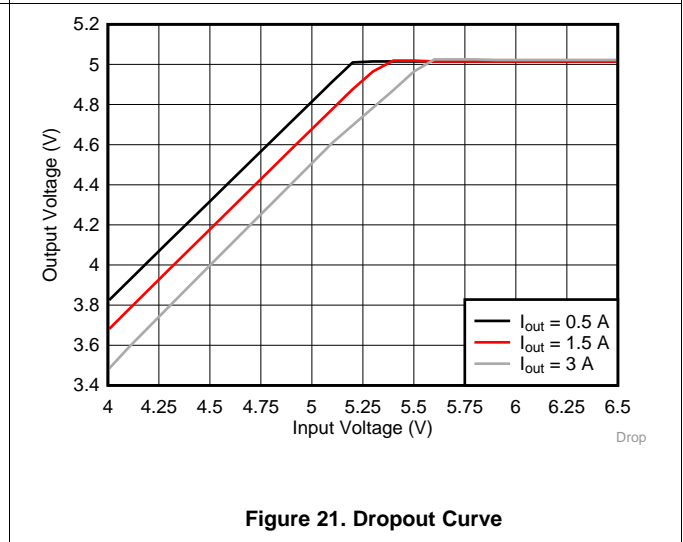
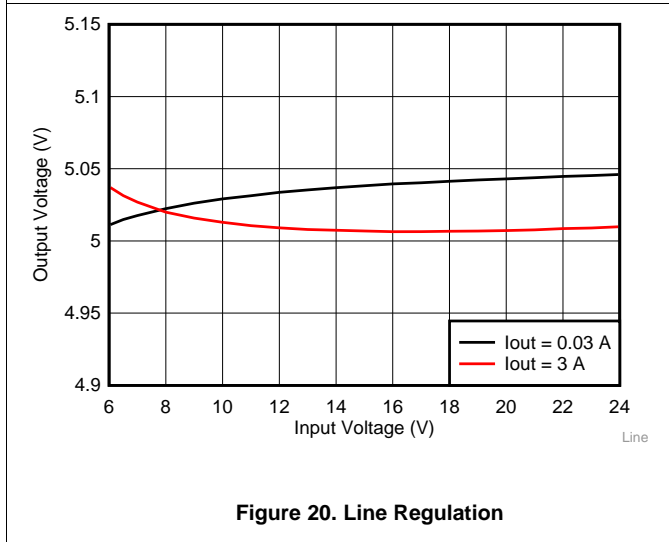
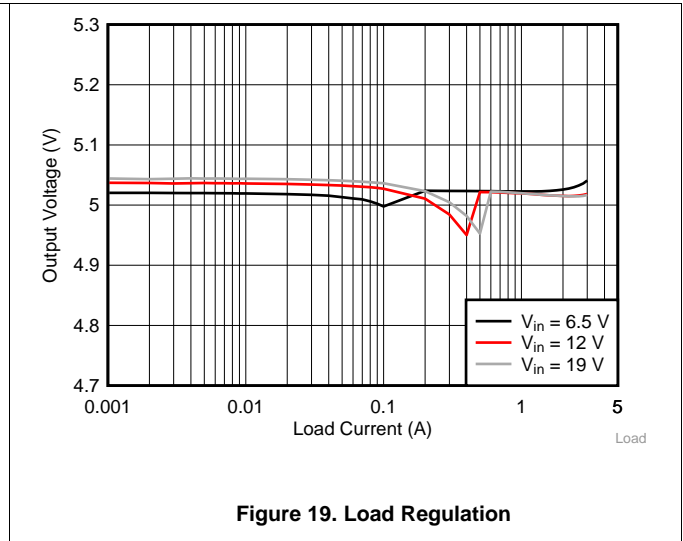
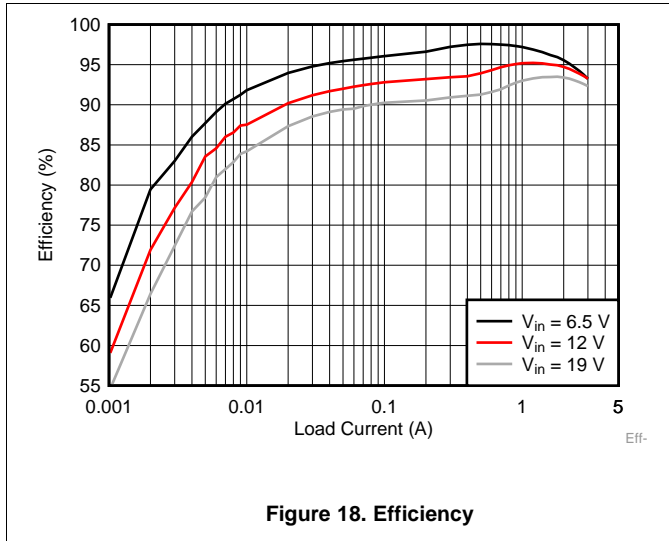

$V_{IN} = 12\text{ V}$ ,  $L_1 = 5.6\ \mu\text{H}$ ,  $C_{OUT} = 44\ \mu\text{F}$ ,  $T_A = 25\ ^\circ\text{C}$ . (unless otherwise noted)

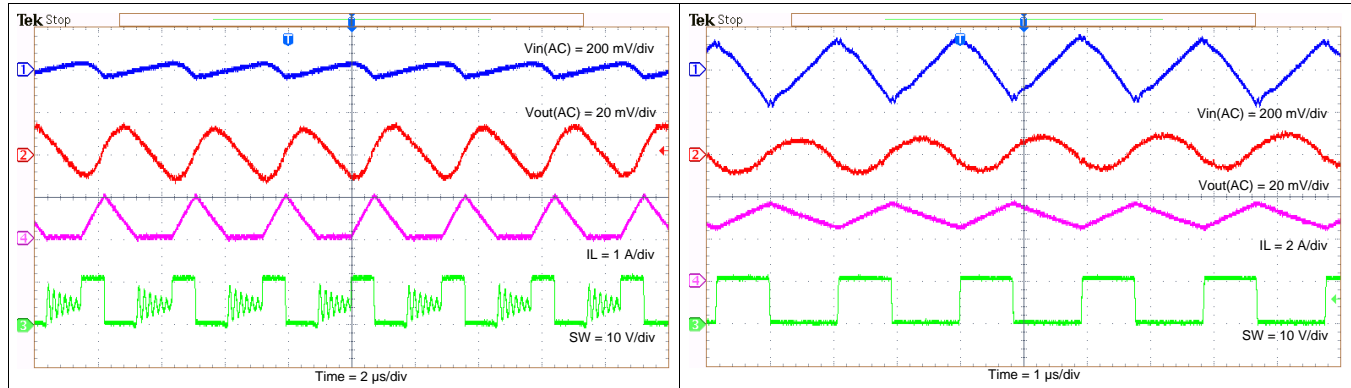

Figure 24. Steady State Waveforms,  $I_{OUT} = 0.3\text{ A}$

Figure 25. Steady State Waveforms,  $I_{OUT} = 3\text{ A}$

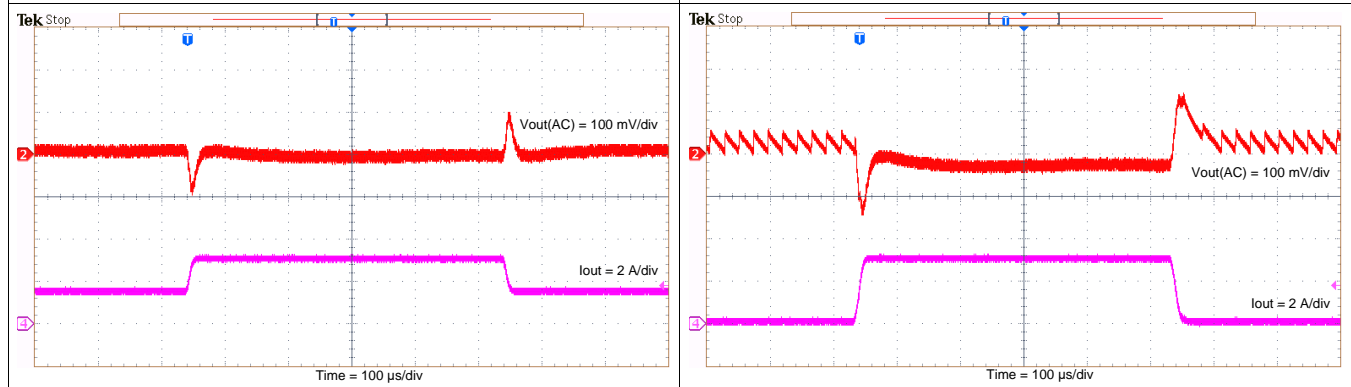

Figure 26. Transient Response 1.5 to 3 A

Figure 27. Transient Response 0.3 to 2.7 A

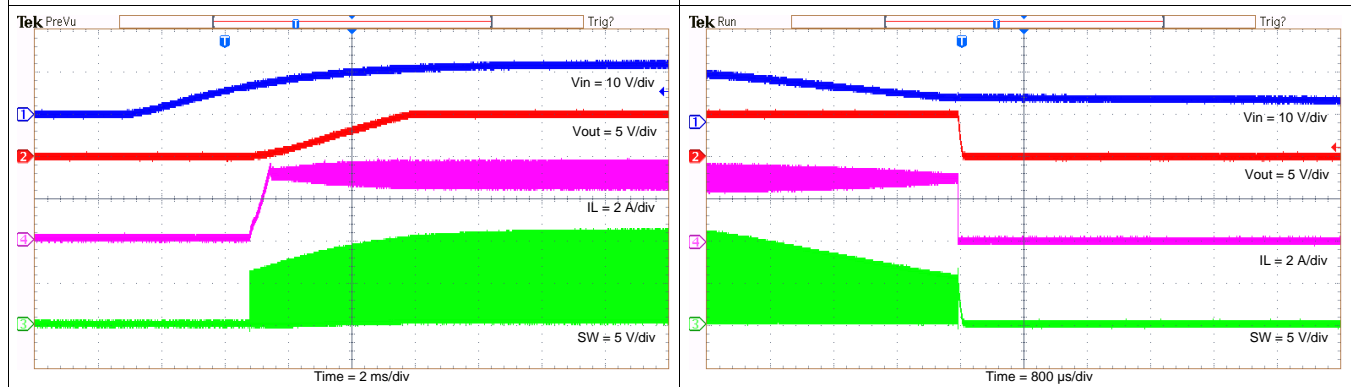

Figure 28. Startup Relative to  $V_{IN}$

Figure 29. Shutdown Relative to  $V_{IN}$

$V_{IN} = 12\text{ V}$ ,  $L_1 = 5.6\ \mu\text{H}$ ,  $C_{OUT} = 44\ \mu\text{F}$ ,  $T_A = 25\ ^\circ\text{C}$ . (unless otherwise noted)

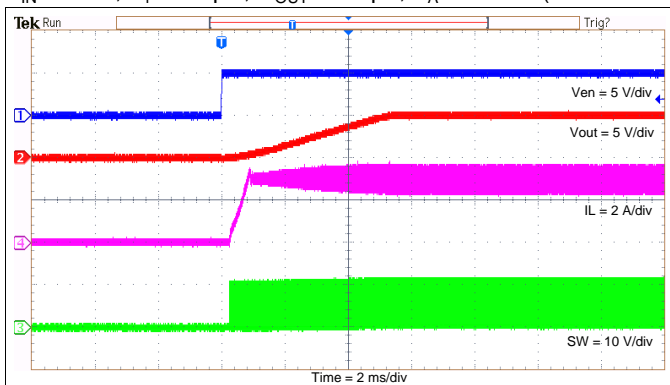

Figure 30. Enable Relative to EN

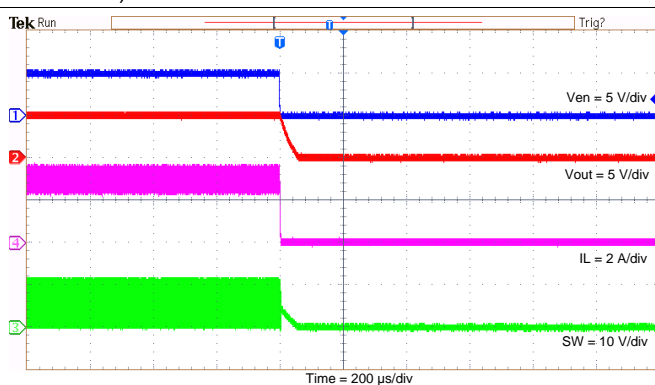

Figure 31. Disable Relative to EN

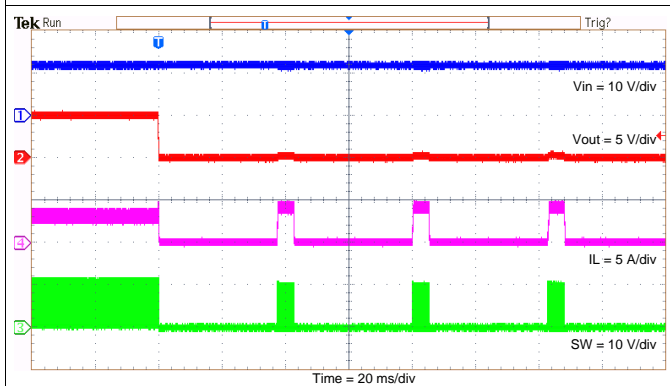

Figure 32. Short Protection

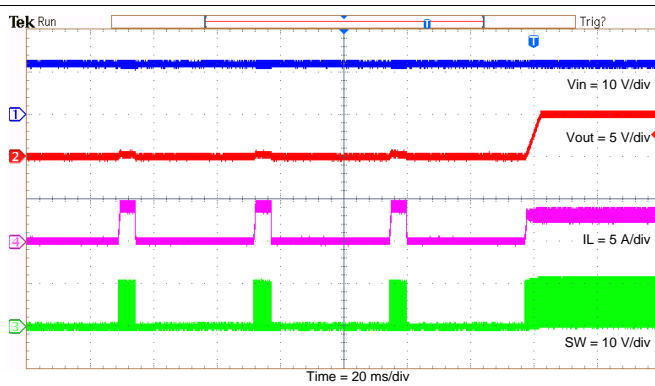

Figure 33. Short Recovery

## 9 Power Supply Recommendations

The devices are designed to operate from an input voltage supply range between 4.5 V and 24 V. This input supply must be well regulated. If the input supply is located more than a few inches from the device or converter, additional bulk capacitance may be required in addition to the ceramic bypass capacitor. An electrolytic capacitor with a value of 47  $\mu\text{F}$  is a typical choice. The 0.1- $\mu\text{F}$  ceramic bypass capacitor should be as close as possible to VIN and GND pins.

## 10 Layout

### 10.1 Layout Guidelines

1. VIN and GND traces should be as wide as possible to reduce trace impedance. The wide areas are also of advantage from the view point of heat dissipation.
2. The input capacitor and output capacitor should be placed as close to the device as possible to minimize trace impedance.
3. The 0.1- $\mu$ F ceramic bypass capacitor should be as close as possible to VIN and GND pins.
4. Provide sufficient vias for the input capacitor and output capacitor.
5. Keep the SW trace as physically short and wide as practical to minimize radiated emissions.
6. Do not allow switching current to flow under the device.
7. A separate VOUT path should be connected to the upper feedback resistor.
8. Make a Kelvin connection to the GND pin for the feedback path.
9. Voltage feedback loop should be placed away from the high-voltage switching trace, and preferably has ground shield.
10. The trace of the VFB node should be as small as possible to avoid noise coupling.
11. The GND trace between the output capacitor and the GND pin should be as wide as possible to minimize its trace impedance.

### 10.2 Layout Example

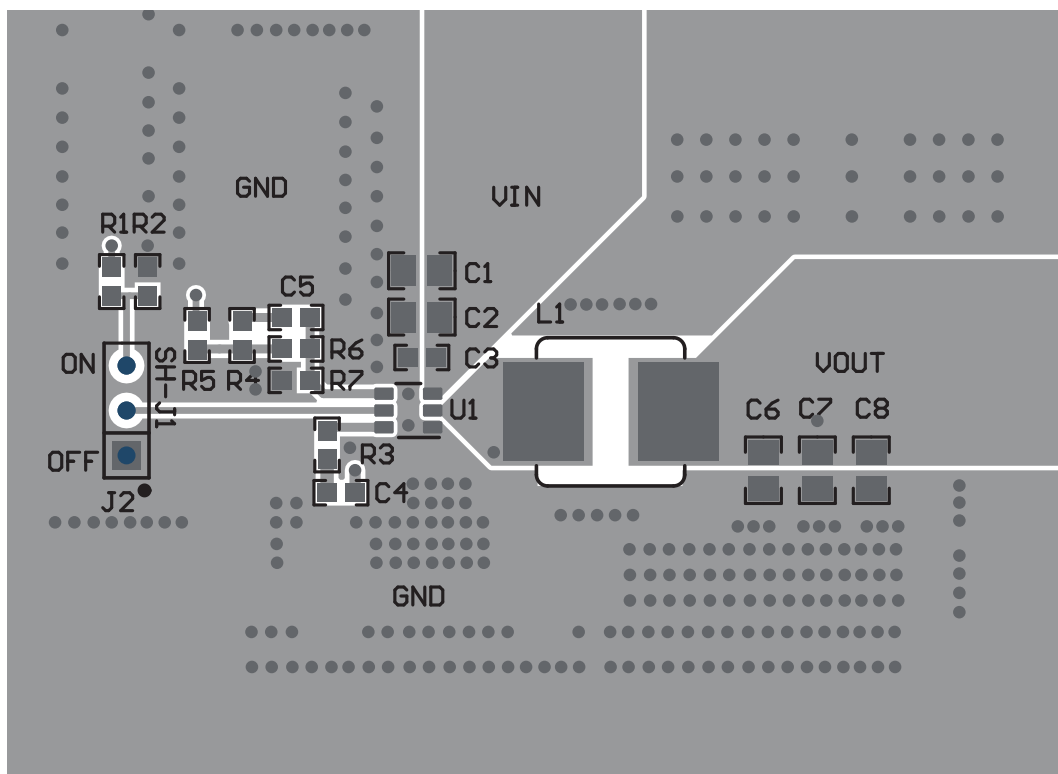

**Figure 34. TPS56339 Top Layout Example**

Layout Example (continued)

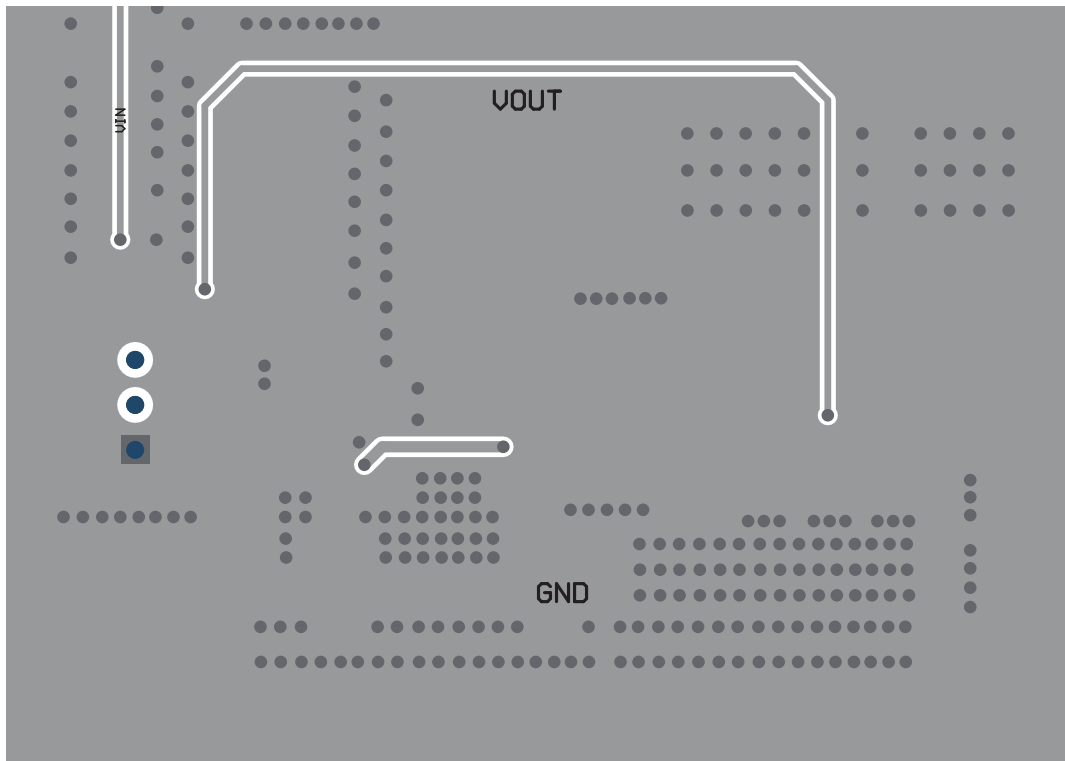

Figure 35. TPS56339 Bottom Layout Example

## 11 Device and Documentation Support

### 11.1 Receiving Notification of Documentation Updates

To receive notification of documentation updates, navigate to the device product folder on ti.com. In the upper right corner, click on *Alert me* to register and receive a weekly digest of any product information that has changed. For change details, review the revision history included in any revised document.

### 11.2 Related Links

The table below lists quick access links. Categories include technical documents, support and community resources, tools and software, and quick access to order now.

### 11.3 Community Resources

The following links connect to TI community resources. Linked contents are provided "AS IS" by the respective contributors. They do not constitute TI specifications and do not necessarily reflect TI's views; see TI's [Terms of Use](#).

**TI E2E™ Online Community** *TI's Engineer-to-Engineer (E2E) Community*. Created to foster collaboration among engineers. At e2e.ti.com, you can ask questions, share knowledge, explore ideas and help solve problems with fellow engineers.

**Design Support** *TI's Design Support* Quickly find helpful E2E forums along with design support tools and contact information for technical support.

### 11.4 Trademarks

E2E is a trademark of Texas Instruments.  
WEBENCH is a registered trademark of Texas Instruments.

### 11.5 Electrostatic Discharge Caution



These devices have limited built-in ESD protection. The leads should be shorted together or the device placed in conductive foam during storage or handling to prevent electrostatic damage to the MOS gates.

### 11.6 Glossary

**SLYZ022** — *TI Glossary*.

This glossary lists and explains terms, acronyms, and definitions.

## 12 Mechanical, Packaging, and Orderable Information

The following pages include mechanical, packaging, and orderable information. This information is the most current data available for the designated devices. This data is subject to change without notice and revision of this document. For browser-based versions of this data sheet, refer to the left-hand navigation.



**PACKAGING INFORMATION**

Orderable Device	Status (1)	Package Type	Package Drawing	Pins	Package Qty	Eco Plan (2)	Lead finish/ Ball material (6)	MSL Peak Temp (3)	Op Temp (°C)	Device Marking (4/5)	Samples
TPS56339DDCR	ACTIVE	SOT-23-THIN	DDC	6	3000	RoHS & Green	SN	Level-1-260C-UNLIM	-40 to 125	T6339	<a href="#">Samples</a>
TPS56339DDCT	ACTIVE	SOT-23-THIN	DDC	6	250	RoHS & Green	SN	Level-1-260C-UNLIM	-40 to 125	T6339	<a href="#">Samples</a>

(1) The marketing status values are defined as follows:

**ACTIVE:** Product device recommended for new designs.

**LIFEBUY:** TI has announced that the device will be discontinued, and a lifetime-buy period is in effect.

**NRND:** Not recommended for new designs. Device is in production to support existing customers, but TI does not recommend using this part in a new design.

**PREVIEW:** Device has been announced but is not in production. Samples may or may not be available.

**OBSOLETE:** TI has discontinued the production of the device.

(2) **RoHS:** TI defines "RoHS" to mean semiconductor products that are compliant with the current EU RoHS requirements for all 10 RoHS substances, including the requirement that RoHS substance do not exceed 0.1% by weight in homogeneous materials. Where designed to be soldered at high temperatures, "RoHS" products are suitable for use in specified lead-free processes. TI may reference these types of products as "Pb-Free".

**RoHS Exempt:** TI defines "RoHS Exempt" to mean products that contain lead but are compliant with EU RoHS pursuant to a specific EU RoHS exemption.

**Green:** TI defines "Green" to mean the content of Chlorine (Cl) and Bromine (Br) based flame retardants meet JS709B low halogen requirements of <=1000ppm threshold. Antimony trioxide based flame retardants must also meet the <=1000ppm threshold requirement.

(3) MSL, Peak Temp. - The Moisture Sensitivity Level rating according to the JEDEC industry standard classifications, and peak solder temperature.

(4) There may be additional marking, which relates to the logo, the lot trace code information, or the environmental category on the device.

(5) Multiple Device Markings will be inside parentheses. Only one Device Marking contained in parentheses and separated by a "~" will appear on a device. If a line is indented then it is a continuation of the previous line and the two combined represent the entire Device Marking for that device.

(6) Lead finish/Ball material - Orderable Devices may have multiple material finish options. Finish options are separated by a vertical ruled line. Lead finish/Ball material values may wrap to two lines if the finish value exceeds the maximum column width.

**Important Information and Disclaimer:**The information provided on this page represents TI's knowledge and belief as of the date that it is provided. TI bases its knowledge and belief on information provided by third parties, and makes no representation or warranty as to the accuracy of such information. Efforts are underway to better integrate information from third parties. TI has taken and continues to take reasonable steps to provide representative and accurate information but may not have conducted destructive testing or chemical analysis on incoming materials and chemicals. TI and TI suppliers consider certain information to be proprietary, and thus CAS numbers and other limited information may not be available for release.

In no event shall TI's liability arising out of such information exceed the total purchase price of the TI part(s) at issue in this document sold by TI to Customer on an annual basis.



## TAPE AND REEL INFORMATION



### QUADRANT ASSIGNMENTS FOR PIN 1 ORIENTATION IN TAPE



\*All dimensions are nominal

Device	Package Type	Package Drawing	Pins	SPQ	Reel Diameter (mm)	Reel Width W1 (mm)	A0 (mm)	B0 (mm)	K0 (mm)	P1 (mm)	W (mm)	Pin1 Quadrant
TPS56339DDCR	SOT-23-THIN	DDC	6	3000	180.0	9.5	3.17	3.1	1.1	4.0	8.0	Q3
TPS56339DDCT	SOT-23-THIN	DDC	6	250	180.0	9.5	3.17	3.1	1.1	4.0	8.0	Q3

## TAPE AND REEL BOX DIMENSIONS



\*All dimensions are nominal

Device	Package Type	Package Drawing	Pins	SPQ	Length (mm)	Width (mm)	Height (mm)
TPS56339DDCR	SOT-23-THIN	DDC	6	3000	184.0	184.0	19.0
TPS56339DDCT	SOT-23-THIN	DDC	6	250	184.0	184.0	19.0

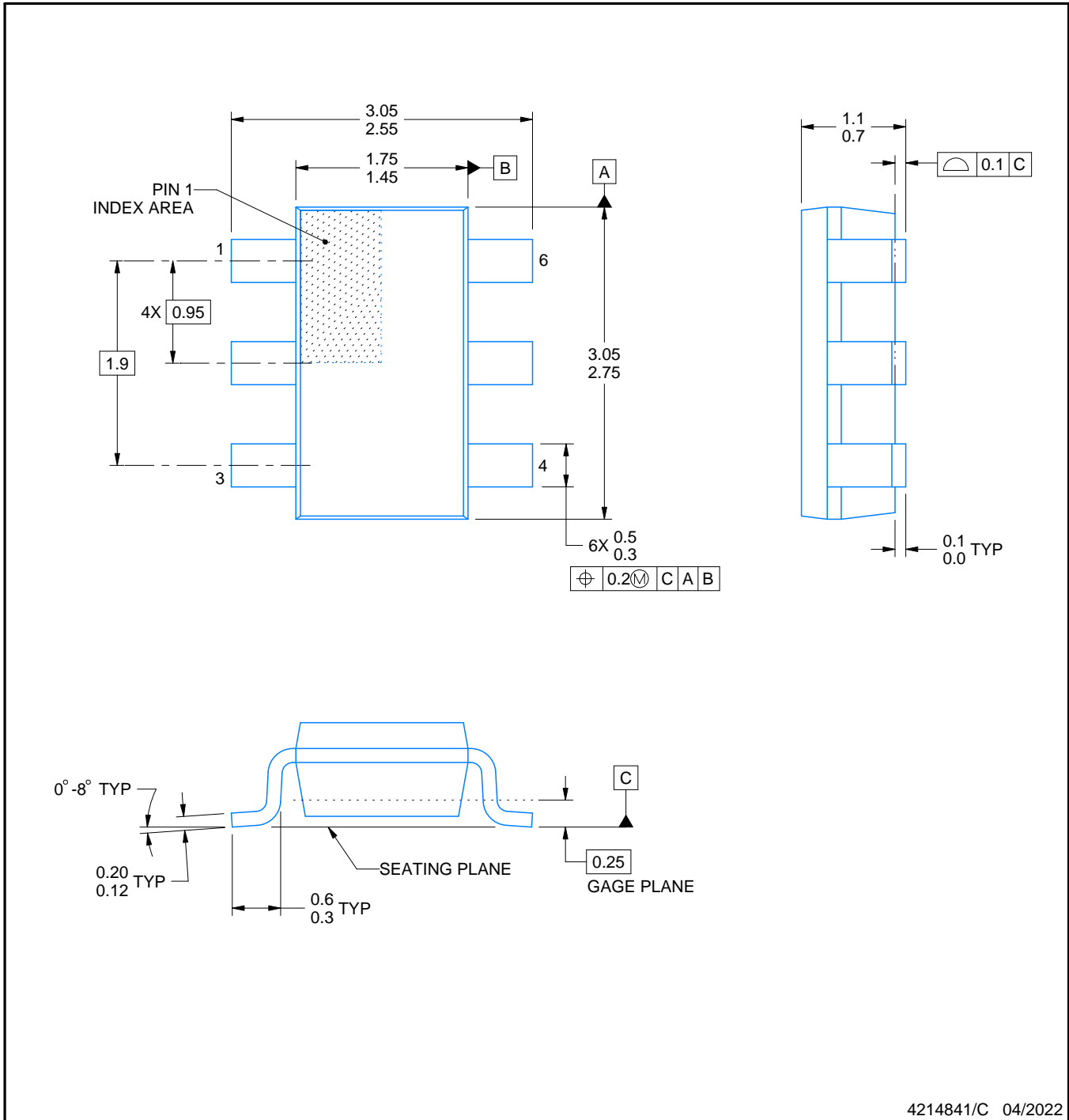

4214841/C 04/2022

NOTES:

1. All linear dimensions are in millimeters. Any dimensions in parenthesis are for reference only. Dimensioning and tolerancing per ASME Y14.5M.
2. This drawing is subject to change without notice.
3. Reference JEDEC MO-193.

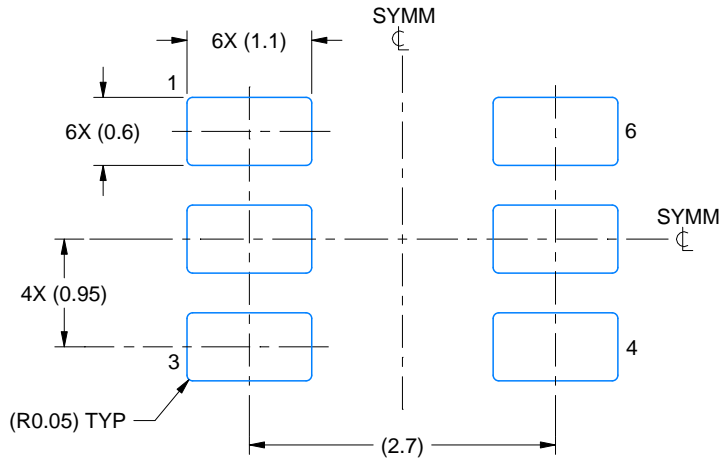

LAND PATTERN EXAMPLE  
EXPLODED METAL SHOWN  
SCALE:15X

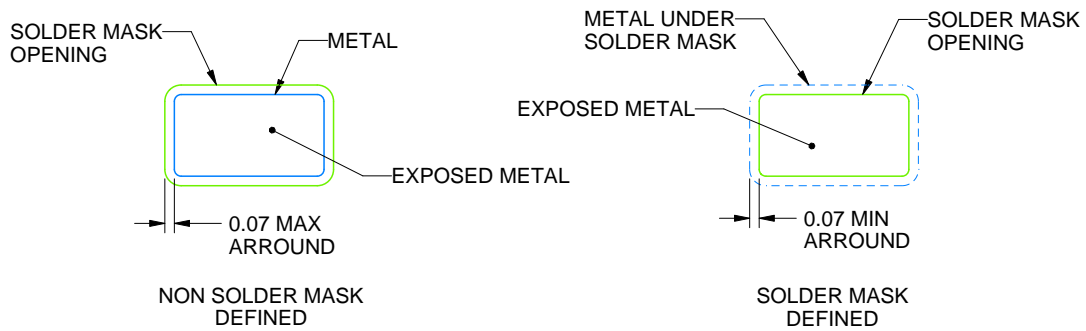

SOLDEMASK DETAILS

4214841/C 04/2022

NOTES: (continued)

- 4. Publication IPC-7351 may have alternate designs.
- 5. Solder mask tolerances between and around signal pads can vary based on board fabrication site.

# EXAMPLE STENCIL DESIGN

DDC0006A

SOT-23 - 1.1 max height

SMALL OUTLINE TRANSISTOR

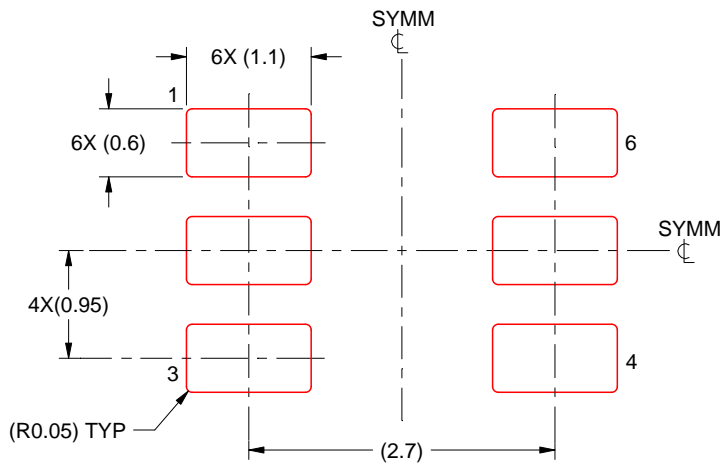

SOLDER PASTE EXAMPLE  
BASED ON 0.125 THICK STENCIL  
SCALE:15X

4214841/C 04/2022

NOTES: (continued)

6. Laser cutting apertures with trapezoidal walls and rounded corners may offer better paste release. IPC-7525 may have alternate design recommendations.
7. Board assembly site may have different recommendations for stencil design.

## IMPORTANT NOTICE AND DISCLAIMER

TI PROVIDES TECHNICAL AND RELIABILITY DATA (INCLUDING DATA SHEETS), DESIGN RESOURCES (INCLUDING REFERENCE DESIGNS), APPLICATION OR OTHER DESIGN ADVICE, WEB TOOLS, SAFETY INFORMATION, AND OTHER RESOURCES "AS IS" AND WITH ALL FAULTS, AND DISCLAIMS ALL WARRANTIES, EXPRESS AND IMPLIED, INCLUDING WITHOUT LIMITATION ANY IMPLIED WARRANTIES OF MERCHANTABILITY, FITNESS FOR A PARTICULAR PURPOSE OR NON-INFRINGEMENT OF THIRD PARTY INTELLECTUAL PROPERTY RIGHTS.

These resources are intended for skilled developers designing with TI products. You are solely responsible for (1) selecting the appropriate TI products for your application, (2) designing, validating and testing your application, and (3) ensuring your application meets applicable standards, and any other safety, security, regulatory or other requirements.

These resources are subject to change without notice. TI grants you permission to use these resources only for development of an application that uses the TI products described in the resource. Other reproduction and display of these resources is prohibited. No license is granted to any other TI intellectual property right or to any third party intellectual property right. TI disclaims responsibility for, and you will fully indemnify TI and its representatives against, any claims, damages, costs, losses, and liabilities arising out of your use of these resources.

TI's products are provided subject to [TI's Terms of Sale](#) or other applicable terms available either on [ti.com](http://ti.com) or provided in conjunction with such TI products. TI's provision of these resources does not expand or otherwise alter TI's applicable warranties or warranty disclaimers for TI products.

TI objects to and rejects any additional or different terms you may have proposed.

Mailing Address: Texas Instruments, Post Office Box 655303, Dallas, Texas 75265  
Copyright © 2022, Texas Instruments Incorporated