



SPECIFICATION SHEET

| | |
|--------------------------------|---------------------------------------------------------------------------------------------------------------------------------------------------------------------------------------------------------------------------------------------------------------------------------------------------------------------------------------------------------------------|
| SPECIFICATION SHEET NO. | N0802-SMAJ48CA00S0YX |
| DATE | Aug. 02, 2021 |
| REVISION | A0 |
| DESCRIPTION | <p>SMD Transient Voltage Suppressor (TVs) Diodes, SMA/DO-214AC series, SMAJ48CA Type, 2 Pads, Bidirectional</p> <p>Reverse Stand-off Voltage 48.0V Max. Peak Pulse Power: 400 Watts Min.</p> <p>Operating Temp. Range -65°C ~+150°C</p> <p>Package in Tape/Reel, 5000pcs/13" Reel or 2000pcs/7" Reel</p> <p>RoHS/RoHS III compliant</p> |
| CUSTOMER | |
| CUSTOMER PART NUMBER | |
| CROSS REF. PART NUMBER | |
| ORIGINAL PART NUMBER | MDD SMAJ48CA |
| PART CODE | SMAJ48CA00S0YX |

| | | | |
|-------------------------|-------------------------------------------------------------------------------------|--------------------------------------------------------------------------------------|---------------------------------------------------------------------------------------|
| VENDOR APPROVE | | | |
| Issued/Checked/Approved |  |  |  |
| DATE: Aug. 02, 2021 | | | |

| | |
|-------------------------|--|
| CUSTOMER APPROVE | |
| | |
| DATE: | |

SMD TRANSIENT VOLTAGE SUPPRESSORS DIODES SMA SERIES



MAIN FEATURE

- The plastic package carries Underwriters Laboratory Flammability Classification 94V-0
- Low profile package
- Built-in strain relief
- High temperature soldering guaranteed: 260°C/ 10 seconds at terminals
- Glass passivated chip junction
- Low inductance
- Excellent clamping capability
- 400W peak pulse power capability at 10/1000µs waveform
- Repetition rate (duty cycle): 0.01%
- Fast response time
- Repetition rate (duty cycle): 0.01%
- Typical IR less than 1µA above 10V

APPLICATION

- I/O interface
- AC/DC power supply
- Low frequency signal transmission line (RS232, RS485, etc.)

RFQ

[Request For Quotation](#)

PART CODE GUIDE

| SMA | J48CA00 | S | OYX |
|-----|---------|---|-----|
| 1 | 2 | 3 | 4 |

- 1) **SMA**: SMD Transient Voltage Suppressor (TVs) Diodes, SMA /DO-214AC series,
- 2) **J48CA00**: Type code for original part number SMAJ48CA
- 3) **S**: Package code, Tape/reel, 5000pcs/13"Reel or 2000pcs/7" Reel
- 4) **OYX**: Marking code for "YX" on the case surface, Different Marking for different specification.

SMD TRANSIENT VOLTAGE SUPPRESSORS DIODES SMA SERIES

MORE ITEMS AVAILABLE- Unidirectional Type

| | | | | |
|----------------|----------------|----------------|----------------|----------------|
| SMAJ050A00S0AE | SMAJ060A00S0AG | SMAJ070A00S0AM | SMAJ075A00S0AP | SMAJ085A00S0AT |
| SMAJ080A00S0AR | SMAJ090A00S0AV | SMAJ10A000S0AX | SMAJ11A000S0AZ | SMAJ12A000S0BE |
| SMAJ13A000S0BG | SMAJ14A000S0BK | SMAJ15A000S0BM | SMAJ16A000S0BP | SMAJ17A000S0BR |
| SMAJ18A000S0BT | SMAJ20A000S0BV | SMAJ22A000S0BX | SMAJ24A000S0BZ | SMAJ26A000S0CE |
| SMAJ28A000S0CG | SMAJ30A000S0CK | SMAJ33A000S0CM | SMAJ36A000S0CP | SMAJ40A000S0CR |
| SMAJ43A000S0CT | SMAJ45A000S0CV | SMAJ48A000S0CX | SMAJ51A000S0CZ | SMAJ54A000S0RE |
| SMAJ58A000S0RG | SMAJ60A000S0RK | SMAJ64A000S0RM | SMAJ70A000S0RP | SMAJ75A000S0RR |
| SMAJ78A000S0RT | SMAJ85A000S0RV | SMAJ90A000S0RX | SMAJ100A00S0RZ | SMAJ110A00S0SE |
| SMAJ120A00S0SG | SMAJ130A00S0SK | SMAJ150A00S0SM | SMAJ160A00S0SP | SMAJ170A00S0SR |
| SMAJ180A00S0ST | SMAJ190A00S0SU | SMAJ200A00S0SV | SMAJ210A00S0SW | SMAJ220A00S0GE |
| SMAJ250A00S0SZ | SMAJ300A00S0TE | SMAJ350A00S0TG | SMAJ400A00S0TK | SMAJ440A00S0TM |
| SMAJ065A00S0AK | | | | |

MORE ITEMS AVAILABLE- Bidirectional Type

| | | | | |
|----------------|----------------|-----------------------|----------------|----------------|
| SMAJ050CA0S0WE | SMAJ060CA0S0WG | SMAJ070CA0S0WM | SMAJ075CA0S0WP | SMAJ080CA0S0WR |
| SMAJ085CA0S0WT | SMAJ090CA0S0WV | SMAJ10CA00S0WX | SMAJ11CA00S0WZ | SMAJ12CA00S0XE |
| SMAJ13CA00S0XG | SMAJ14CA00S0XK | SMAJ15CA00S0XM | SMAJ16CA00S0XP | SMAJ17CA00S0XR |
| SMAJ18CA00S0XT | SMAJ20CA00S0XV | SMAJ22CA00S0XX | SMAJ24CA00S0XZ | SMAJ26CA00S0YE |
| SMAJ28CA00S0YG | SMAJ30CA00S0YK | SMAJ33CA00S0YM | SMAJ36CA00S0YP | SMAJ40CA00S0YR |
| SMAJ43CA00S0YT | SMAJ45CA00S0YV | SMAJ48CA00S0YX | SMAJ51CA00S0YZ | SMAJ54CA00S0ZE |
| SMAJ58CA00S0ZG | SMAJ60CA00S0ZK | SMAJ64CA00S0ZM | SMAJ70CA00S0ZP | SMAJ75CA00S0ZR |
| SMAJ78CA00S0ZT | SMAJ85CA00S0ZV | SMAJ90CA00S0ZX | SMAJ100CA0S0ZZ | SMAJ110CA0S0VE |
| SMAJ120CA0S0VG | SMAJ130CA0S0VK | SMAJ150CA0S0VM | SMAJ160CA0S0VP | SMAJ170CA0S0VR |
| SMAJ180CA0S0VT | SMAJ190CA0S0YU | SMAJ200CA0S0VV | SMAJ210CA0S0YW | SMAJ220CA0S0VX |
| SMAJ250CA0S0VZ | SMAJ300CA0S0UE | SMAJ350CA0S0UG | SMAJ400CA0S0UK | SMAJ440CA0S0UM |
| SMAJ065CA0S0AK | | | | |

SMD TRANSIENT VOLTAGE SUPPRESSORS DIODES SMA SERIES

DIMENSION (Unit: Inch/mm)

Image for reference



Marking: YX

SMA/DO-214AC

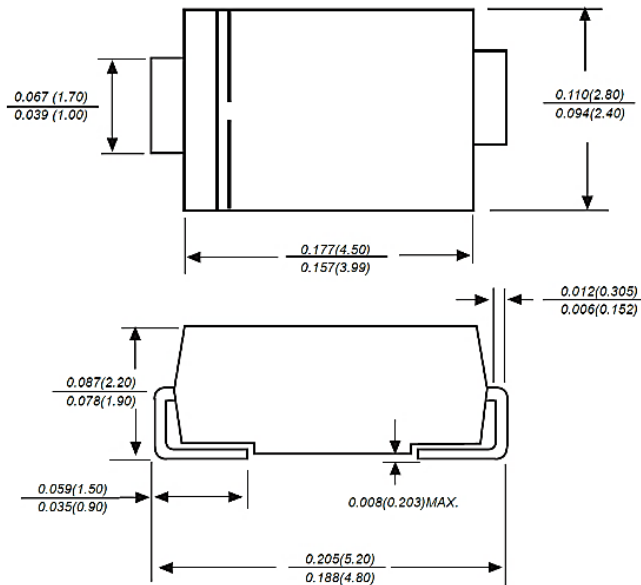

Recommend Pad Layout



| Symbol | Unit (Inch) | Unit (mm) |
|--------|-------------|-----------|
| A | 0.066 | 1.680 |
| B | 0.060 | 1.520 |
| C | 0.154 | 3.900 |
| D | 0.095 | 2.410 |
| E | 0.215 | 5.450 |

SMD TRANSIENT VOLTAGE SUPPRESSORS DIODES SMA SERIES
MECHANICAL DATA

| Case | Terminals | Polarity | Mounting Position | Weight per piece |
|----------------------------------------|--------------------------------------------------------|---------------------------------|-------------------|----------------------------|
| JEDEC SMA/DO-214AC molded plastic body | Solder plated, Solderable per MIL-STD-750, Method 2026 | Polarity symbol marking on case | Any | 0.0020 Ounce, 0.0622 grams |

MAX. RATING & CHARACTERISTICS - Ratings at 25°C ambient temperature unless otherwise specified.

| Parameter | SYMBOLS | VALUE | | | UNITS |
|--------------------------------------------------------------------------------------------------|---------|-------|---------|------|-------|
| | | Min. | Typical | Max. | |
| Peak pulse power dissipation at 10/1000µs waveform (Note1, Note2, Fig.1) | P ppm | 400 | | | W |
| Peak pulse current of at 10/1000µs waveform (Note 1, Fig.3) | I ppm | | | 5.2 | A |
| Steady state power dissipation at TA=50°C (Fig.5) | P M(AV) | | 3.3 | | W |
| Peak forward surge current 8.3ms single half sine-wave superimposed on rated load (JEDEC Method) | I FSM | | 40 | | A |
| Thermal resistance junction to lead | R QJL | | 30 | | °C/W |
| Thermal resistance junction to ambient | R QJA | | 120 | | °C/W |
| Operating junction temperature range | T J | -65 | | +150 | °C |
| Storage temperature range | T STG | -65 | | +150 | °C |

Note

1. Non-repetitive current pulse, per Fig 3 and derated above TA=25 °C per Fig 2
2. Mounted on 5.0*5.0mm(Thickness 0.03mm) copper pads to each terminal
3. 8.3ms single half sine – wave or equivalent square wave, duty cycle – 4 pulsed per minute Max

ELECTRICAL CHARACTERISTICS - Ratings at 25°C

| Parameter | SYMBOLS | VALUE | UNITS |
|--------------------------------|---------|-------------|-------|
| Reverse Stand-Off Voltage | V RWM | 48.0 | V |
| Breakdown Voltage @I T | V BR | 53.30~58.90 | V |
| Test Current | I T | 1 | mA |
| Maximum Clamping Voltage @I PP | V C | 77.40 | V |
| Peak Pulse Current | I PP | 5.2 | A |
| Reverse Leakage @V RWM | I R | 1 | µA |

SMD TRANSIENT VOLTAGE SUPPRESSORS DIODES SMA SERIES
RELIABILITY

| Number | Experiment Items | Experiment Method And Conditions | Reference Documents |
|--------|------------------------------------|----------------------------------------------------------------------------------------------------------------|---------------------------------|
| 1 | Solder Resistance Test | Test 260°C± 5°C for 10 ± 2 sec. Immerse body into solder 1/16" ± 1/32" | MIL-STD-750D METHOD-2031.2 |
| 2 | Solderability Test | 230°C ±5°C for 5 sec. | MIL-STD-750D METHOD-2026.1 0 |
| 3 | Pull Test | 1 kg in axial lead direction for 10 sec. | MIL-STD-750D METHOD-2036.4 |
| 4 | Bend Test | 0.5Kg Weight Applied To Each Lead, Bending Arcs 90 °C ± 5 °C For 3 Times | MIL-STD-750D METHOD-2036.4 |
| 5 | High Temperature Reverse Bias Test | TA=100°C for 1000 Hours at VR=80% Rated VR | MIL-STD-750D METHOD-1038.4 |
| 6 | Forward Operation Life Test | TA=25°C Rated Average Rectified Current | MIL-STD-750D METHOD-1027.3 |
| 7 | Intermittent Operation Life Test | On state: 5 min with rated IRMS Power Off state: 5 min with Cool Forced Air. On and off for 1000 cycles. | MIL-STD-750D METHOD-1036.3 |
| 8 | Pressure Cooker Test | 15 PSIG, TA=121°C, 4 hours | MIL-S-19500 APPENOIXC |
| 9 | Temperature Cycling Test | -55°C~+125°C; 30 Minutes For Dwelled Time 5 minutes for transferred time. Total: 10 cycles. | MIL-STD-750D METHOD-1051.7 |
| 10 | Thermal Shock Test | 0°C for 5 minutes., 100°C for 5minutes, Total: 10 cycles | MIL-STD-750D METHOD-1056.7 |
| 11 | Forward Surge Test | 8.3ms Single Sale Sine-wave One Surge. | MIL-STD-750D METHOD-4066.4 |
| 12 | Humidity Test | TA=65°C, RH=98% for 1000 hours. | MIL-STD-750D METHOD-1021.3 |
| 13 | High Temperature Storage life Test | 150°C for 1000 Hours | MIL-STD-750D METHOD-1031.5 |

SMD TRANSIENT VOLTAGE SUPPRESSORS DIODES SMA SERIES

SUGGESTED REFLOW PROFILE (For Reference Only)

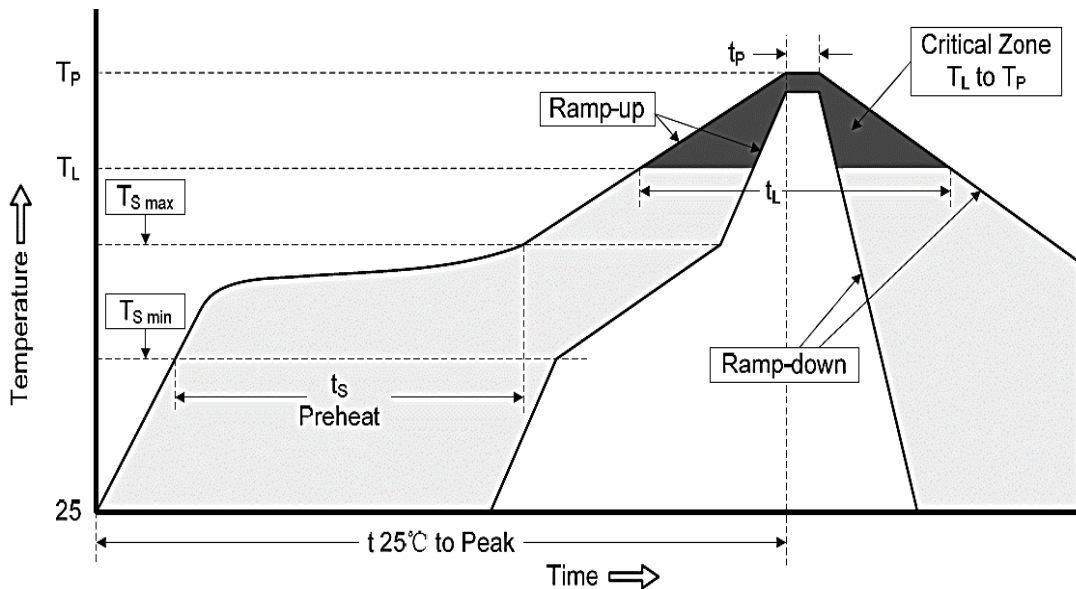

| | | |
|--------------------------------------------------------|----------------------------------|-------------------|
| Profile Feature | | Pb-Free Assembly |
| Average Ramp-up Rate (Ts Max to Tp) | | 3°C/second Max |
| Preheat | Temperature Min (Ts Min.) | 150°C |
| | Temperature Max (Ts Max.) | 200°C |
| | Time (ts Min. to ts Max.) | 60 ~ 180 seconds |
| Time maintained above | Temperature (Tl) | 217°C |
| | Time (tl) | 60 ~ 150 seconds |
| Peak/Classification Temperature (Tp) | | 260 °C |
| Time within 5°C of actual Peak Temperature (tp) | | 20 ~ 40 seconds |
| Ramp-down rate | | 6 °C /Second Max. |
| Time 25 °C to Peak Temperature | | 8 minutes Max. |
| Suggest reflow times | | 3 Times Max. |

SMD TRANSIENT VOLTAGE SUPPRESSORS DIODES SMA SERIES

RATINGS AND CHARACTERISTIC CURVES (For Reference Only)

Figure 1. Peak Pulse Power Rating Curve

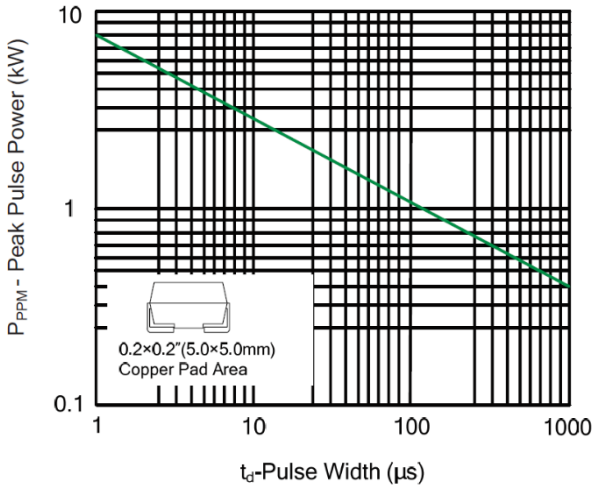

Figure 2. Pulse Derating Curve

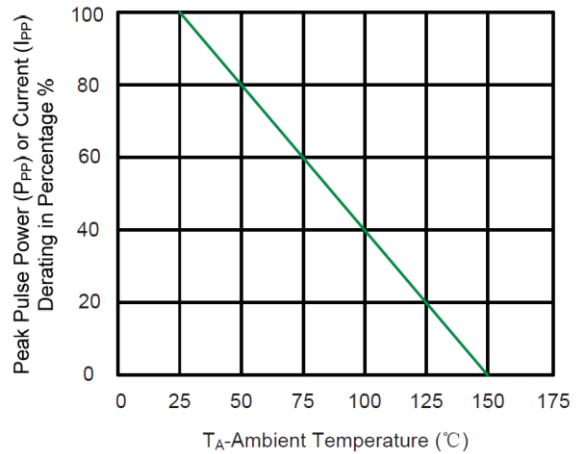

Figure 3. Pulse Waveform

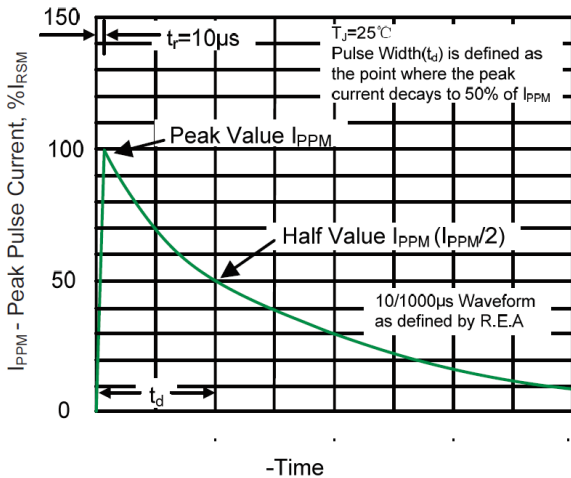

Figure 5. Steady State Power Dissipation Derating curve

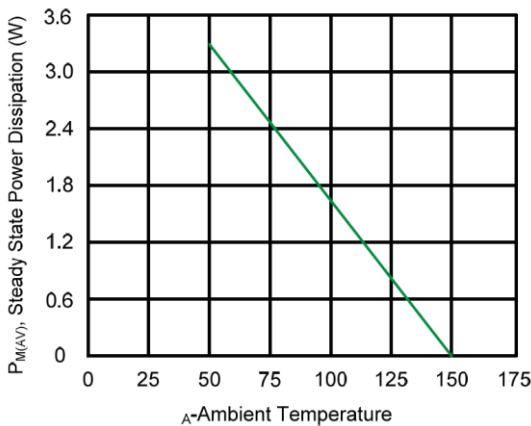
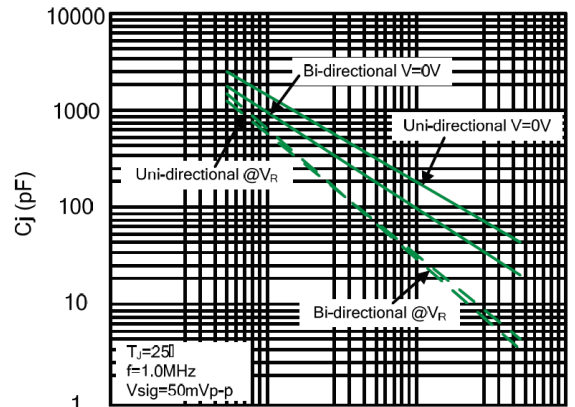
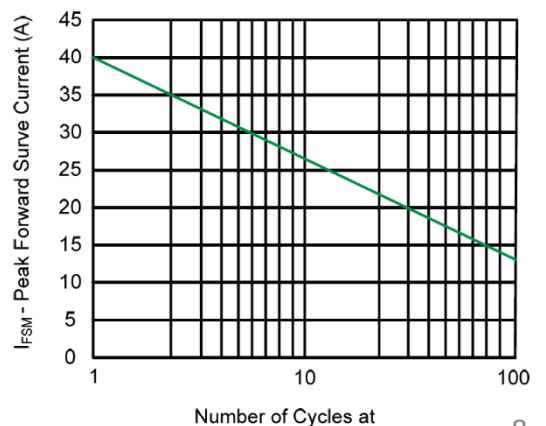

Figure 4. Typical Junction Capacitance



-Reverse Breakdown Voltage

Figure 6. Maximum Non-Repetitive Forward Surge Current Uni-Directional Only



SMD TRANSIENT VOLTAGE SUPPRESSORS DIODES SMA SERIES

TAPE/REEL (Unit: mm)

All Devices are packed in accordance with EIA standard RS-481-A and specifications.



| Item | Symbol | Tolerance | SMA/DO-214AC |
|---------------------------|--------|-----------|--------------|
| Carrier width | A | 0.1 | 2.8 |
| Carrier Length | B | 0.1 | 5.33 |
| Carrier Depth | C | 0.1 | 2.36 |
| Sprocket hole | d | 0.05 | 1.50 |
| 13" Reel outside diameter | D | 2.0 | 330.0 |
| 13" Reel inner diameter | D1 | - | 50.0Min. |
| 7" Reel outside diameter | D | 2.0 | 178.0 |
| 7" Reel inner diameter | D1 | - | 62.0 |
| Feed hole diameter | D2 | 0.5 | 13.00 |
| Sprocket hole position | E | 0.1 | 1.75 |
| Punch hole position | F | 0.1 | 5.50 |
| Punch hole pitch | P | 0.1 | 4.00 |
| Sprocket hole pitch | P0 | 0.1 | 4.00 |
| Embossment center | P1 | 0.1 | 2.0 |
| Overall tape thickness | T | 0.1 | 0.28 |
| Tape width | W | 0.3 | 12.00 |
| Reel width | W1 | 1.0 | 18.0 |

SMD TRANSIENT VOLTAGE SUPPRESSORS DIODES SMA SERIES

PACKAGE

| Case Code | Reel Size | MPQ (pcs) | Component Spacing (mm) | Qty. Per Box (pcs) | Inner Box L*W*H (mm) | Reel Size (mm) | Carton size L*W*H (mm) | Qty. Per Carton (pcs) | G. W (kg) |
|-----------|-----------|-----------|------------------------|--------------------|----------------------|----------------|------------------------|-----------------------|-----------|
| SMA | 7" | 2,000 | | 2,000 | 185*185*40 | 178 | 400*400*250 | 80,000 | 12.0 |
| SMA | 13" | 5,000 | | 5,000 | 335*335*40 | 330 | 380*380*380 | 80,000 | 12.0 |

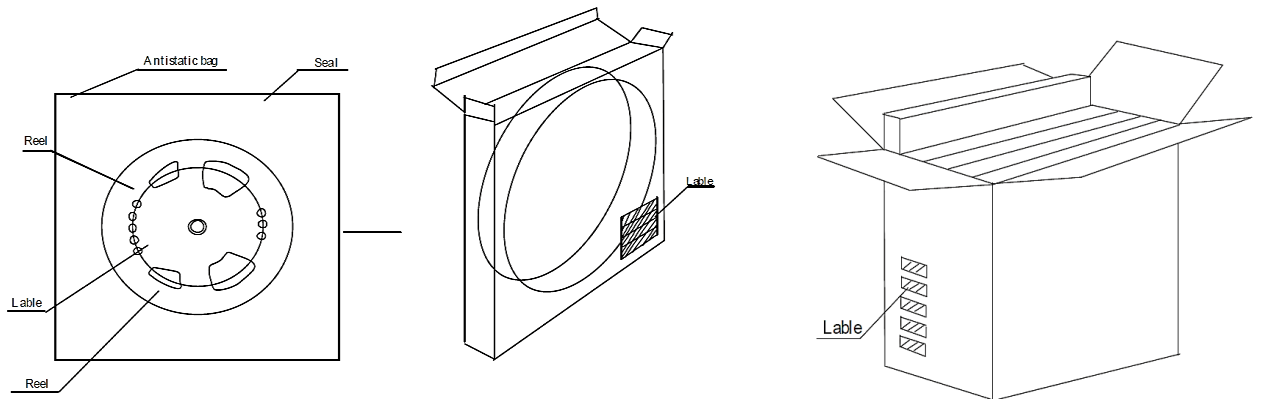

DISCLAIMER

NextGen Component, Inc. reserves the right to make changes to the product(s) and or information contained herein without notice. No liability is assumed as a result of their use or application. No rights under any patent accompany the sale of any such product(s) or information