

## Ultra Low Noise Low Dropout Voltage Regulator

### ■ GENERAL DESCRIPTION

The NJM2863/64 is a low dropout voltage regulator designed for VCO Applications.

Advanced Bipolar technology achieves ultra low noise, high ripple rejection and low quiescent current.

### ■ PACKAGE OUTLINE

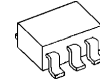

NJM2863F/64F

### ■ FEATURES

- High Ripple Rejection      75dB typ. (f=1kHz, Vo=3V Version)
- Output capacitor with 1.0 $\mu$ F ceramic capacitor
- Output Noise Voltage      Vno=19 $\mu$ Vrms typ. (Cp=0.01 $\mu$ F, Co=1.0 $\mu$ F(Ceramic))  
Vno=12 $\mu$ Vrms typ. (Cp=0.1 $\mu$ F, Co=10 $\mu$ F(Tantalum))
- Output Current              Io(max.)=100mA
- High Precision Output      Vo $\pm$ 1.0%
- Low Dropout Voltage      0.10V typ. (Io=60mA)
- ON/OFF Control            (Active High)
- Internal Short Circuit Current Limit
- Internal Thermal Overload Protection
- Bipolar Technology
- Package Outline            SOT-23-5

### ■ PIN CONFIGURATION

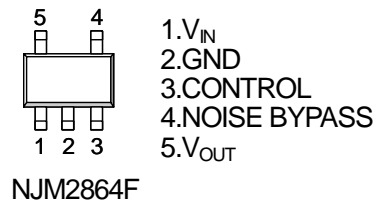
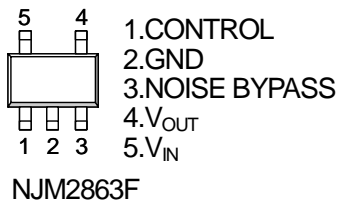

### ■ EQUIVALENT CIRCUIT

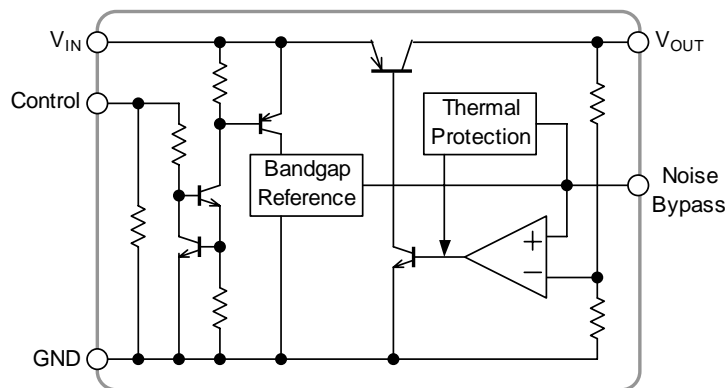

# NJM2863/64

## ■ OUTPUT VOLTAGE RANK LIST

Device Name	V <sub>OUT</sub>	Device Name	V <sub>OUT</sub>
NJM286×F21	2.1V	NJM286×F29	2.9V
NJM286×F25	2.5V	NJM286×F03	3.0V
NJM286×F27	2.7V	NJM286×F33	3.3V
NJM286×F28	2.8V	NJM286×F05	5.0V
NJM286×F285	2.85V		

## ■ ABSOLUTE MAXIMUM RATINGS

(Ta=25°C)

PARAMETER	SYMBOL	RATINGS	UNIT
Input Voltage	V <sub>IN</sub>	+14	V
Control Voltage	V <sub>CONT</sub>	+14(*1)	V
Power Dissipation	P <sub>D</sub>	SOT-23-5 350(*2) 200(*3)	mW
Operating Temperature	T <sub>opr</sub>	-40 ~ +85	°C
Storage Temperature	T <sub>stg</sub>	-40 ~ +125	°C

(\*1): When input voltage is less than +14V, the absolute maximum control voltage is equal to the input voltage.

(\*2): Mounted on glass epoxy board based on EIA/JEDEC. (114.3x76.2x1.6mm: 2Layers)

(\*3): Device itself.

## ■ ELECTRICAL CHARACTERISTICS (V<sub>IN</sub>=V<sub>o</sub>+1V, C<sub>IN</sub>=0.1μF, C<sub>o</sub>=1.0μF, C<sub>p</sub>=0.01μF, Ta=25°C)

PARAMETER	SYMBOL	TEST CONDITION	MIN.	TYP.	MAX.	UNIT
Output Voltage	V <sub>o</sub>	I <sub>o</sub> =30mA	-1.0%	—	+1.0%	V
Quiescent Current	I <sub>Q</sub>	I <sub>o</sub> =0mA, except I <sub>cont</sub>	—	120	180	μA
Quiescent Current at Control OFF	I <sub>Q(OFF)</sub>	V <sub>CONT</sub> =0V	—	—	100	nA
Output Current	I <sub>o</sub>	V <sub>o</sub> -0.3V	100	130	—	mA
Line Regulation	ΔV <sub>o</sub> /ΔV <sub>IN</sub>	V <sub>IN</sub> =V <sub>o</sub> +1V ~ V <sub>o</sub> +6V, I <sub>o</sub> =30mA	—	—	0.10	%/V
Load Regulation	ΔV <sub>o</sub> /ΔI <sub>o</sub>	I <sub>o</sub> =0 ~ 100mA	—	—	0.03	%/mA
Dropout Voltage	ΔV <sub>I-O</sub>	I <sub>o</sub> =60mA	—	0.10	0.18	V
Ripple Rejection	RR	e <sub>in</sub> =200mVrms, f=1kHz, I <sub>o</sub> =10mA, V <sub>o</sub> =3V Version	—	75	—	dB
Average Temperature Coefficient of Output Voltage	ΔV <sub>o</sub> /ΔTa	Ta=0~85°C, I <sub>o</sub> =10mA	—	± 50	—	ppm/°C
Output Noise Voltage1	V <sub>NO1</sub>	f=10Hz~80kHz, I <sub>o</sub> =10mA, C <sub>p</sub> =0.01μF, C <sub>o</sub> =1.0μF (Ceramic), V <sub>o</sub> =3V Version	—	19	—	μVrms
Output Noise Voltage2	V <sub>NO2</sub>	f=10Hz~80kHz, I <sub>o</sub> =10mA, C <sub>p</sub> =0.1μF, C <sub>o</sub> =10μF (Tantalum), V <sub>o</sub> =3V Version	—	12	—	μVrms
Control Voltage for ON-state	V <sub>CONT(ON)</sub>		1.6	—	—	V
Control Voltage for OFF-state	V <sub>CONT(OFF)</sub>		—	—	0.6	V

The above specification is a common specification for all output voltages.

Therefore, it may be different from the individual specification for a specific output voltage.

## ■ TEST CIRCUIT

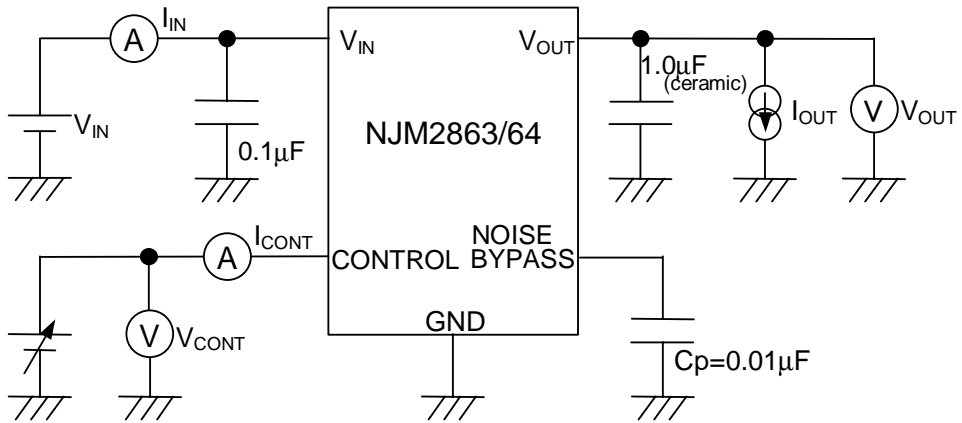

# NJM2863/64

## ■ TYPICAL APPLICATION

① In the case where ON/OFF Control is not required:

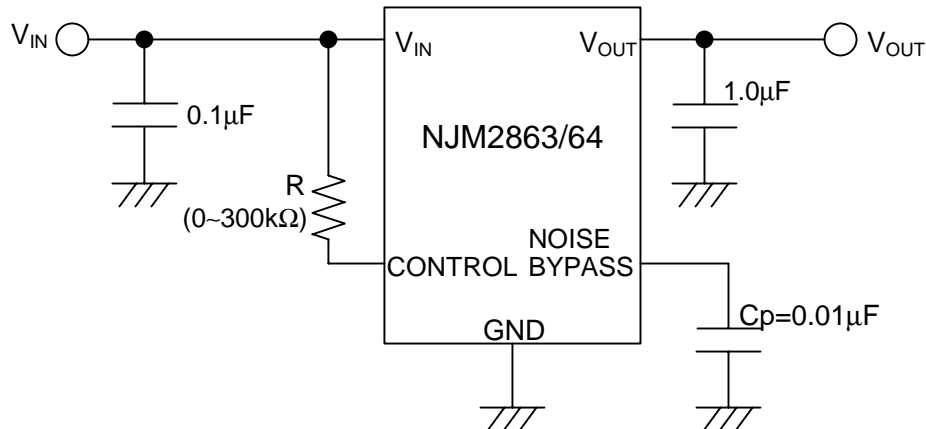

Connect control terminal to  $V_{IN}$  terminal

② In use of ON/OFF CONTROL:

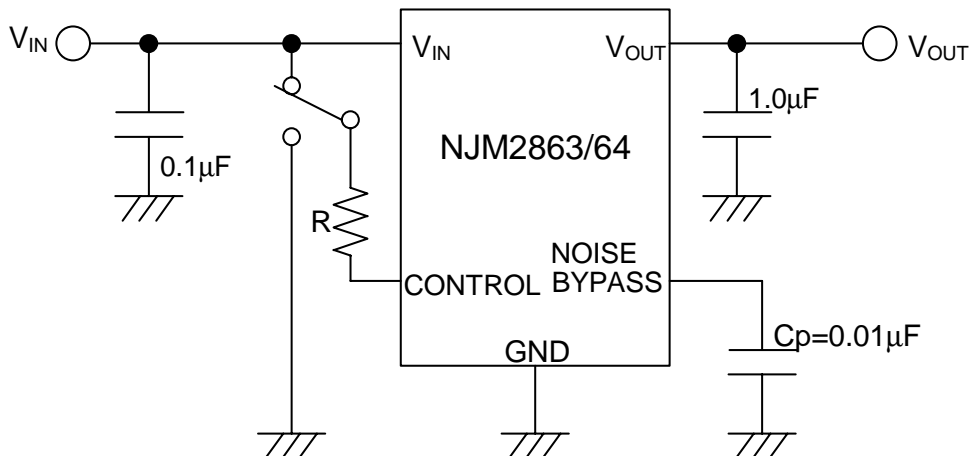

State of control terminal:

- "H" → output is enabled.
- "L" or "open" → output is disabled.

### \*Noise bypass Capacitance $C_p$

Noise bypass capacitance  $C_p$  reduces noise generated by band-gap reference circuit. Noise level and ripple rejection will be improved when larger  $C_p$  is used. Use of smaller  $C_p$  value may cause oscillation. Use the  $C_p$  value of  $0.01\mu\text{F}$  greater to avoid the problem.

### \*In the case of using a resistance "R" between $V_{IN}$ and control.

The current flow into the control terminal while the IC is ON state ( $I_{CONT}$ ) can be reduced when a pull up resistance "R" is inserted between  $V_{IN}$  and the control terminal. The minimum control voltage for ON state ( $V_{CONT(ON)}$ ) is increased due to the voltage drop caused by  $I_{CONT}$  and the resistance "R". The  $I_{CONT}$  is temperature dependence as shown in the "Control Current vs. Temperature" characteristics. Therefore, the resistance "R" should be carefully selected to ensure the control voltage exceeds the  $V_{CONT(ON)}$  over the required temperature range.

## POWER DISSIPATION vs. AMBIENT TEMPERATURE

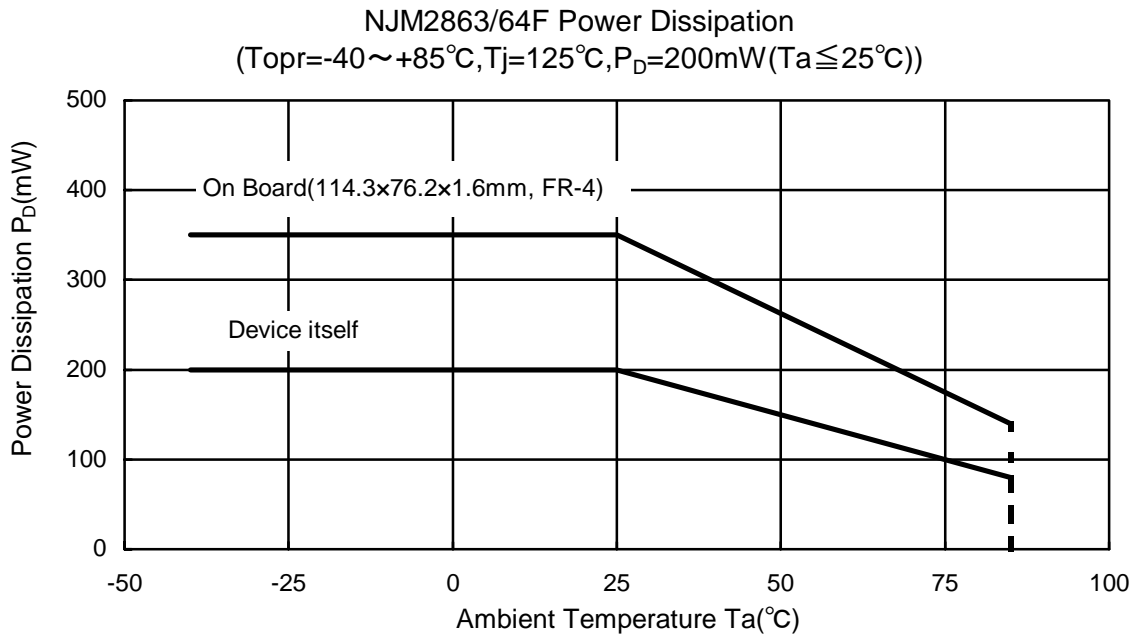

# NJM2863/64

## ELECTRICAL CHARACTERISTICS

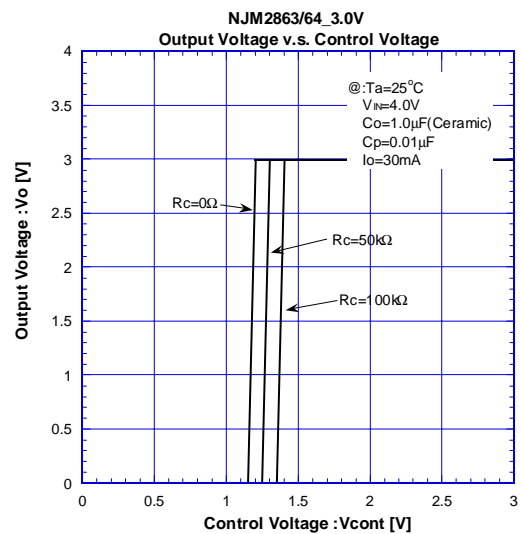
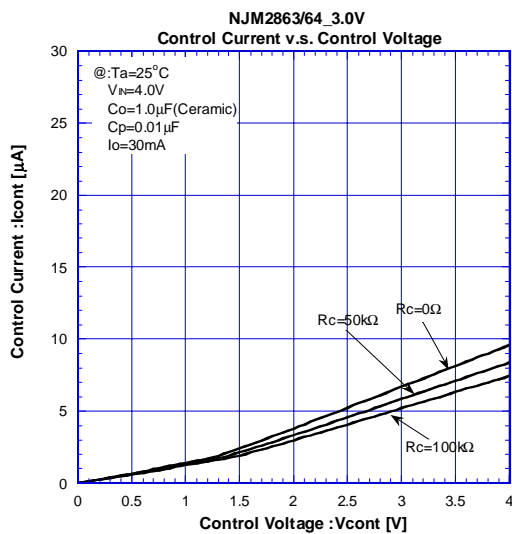
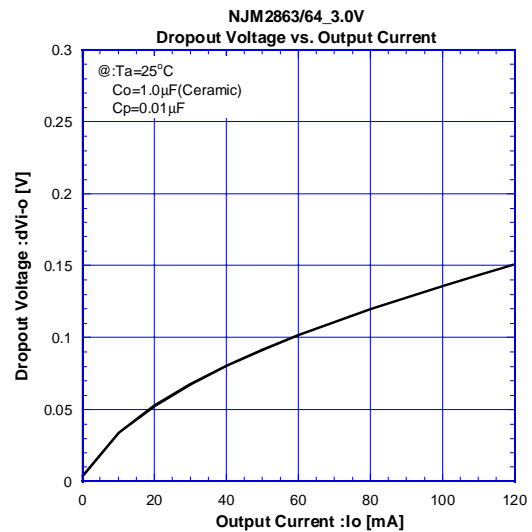
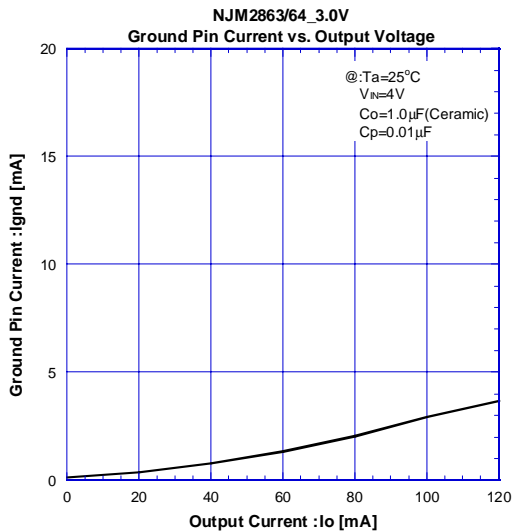
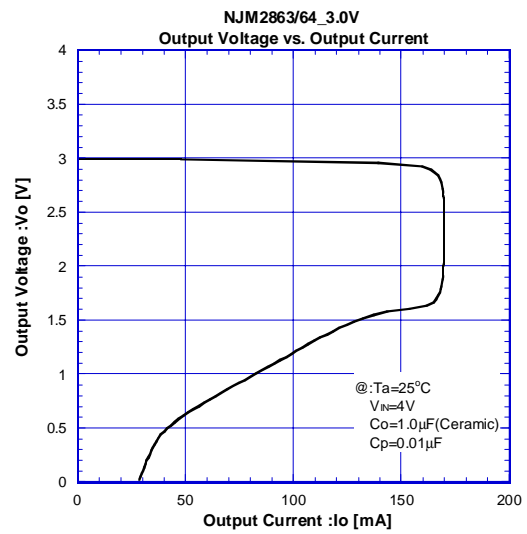
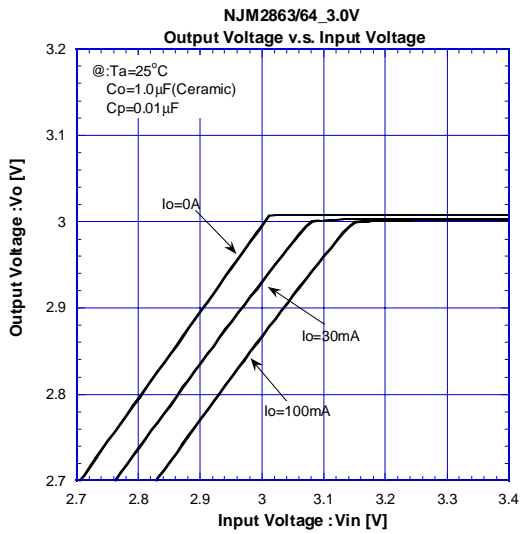

## ■ ELECTRICAL CHARACTERISTICS

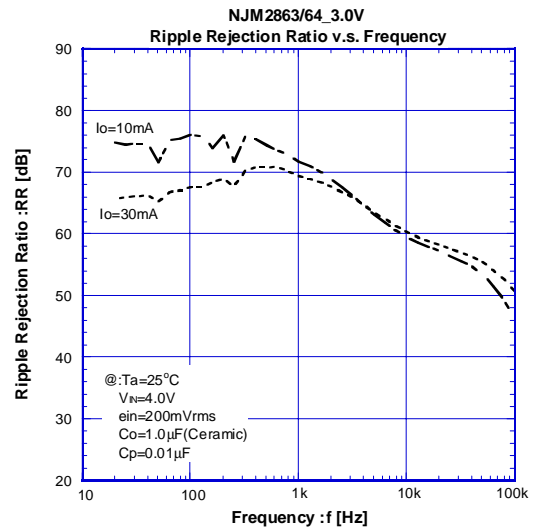
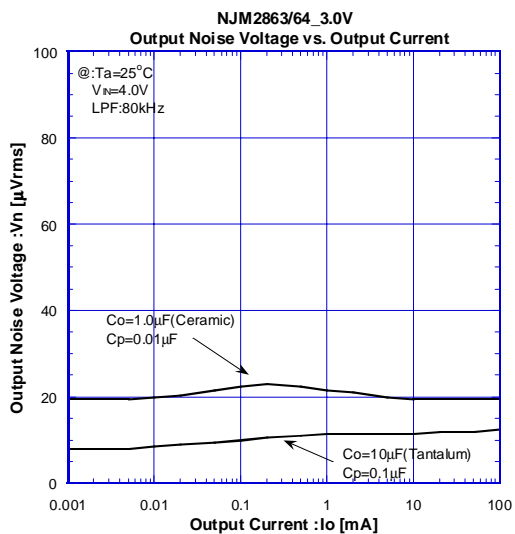
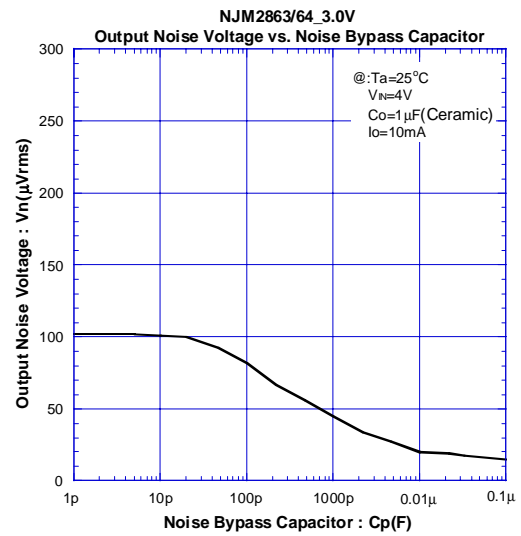
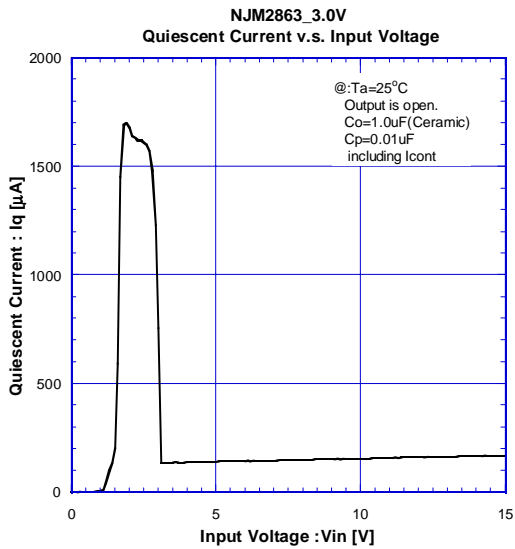
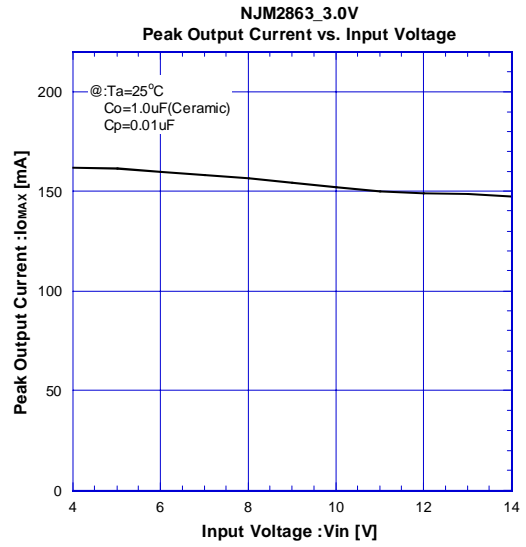
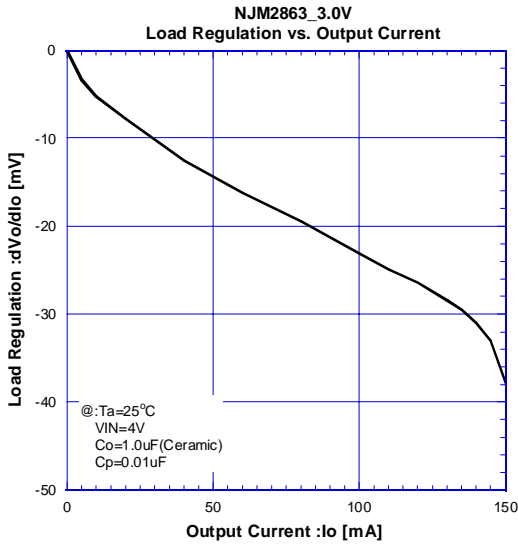

# NJM2863/64

## ELECTRICAL CHARACTERISTICS

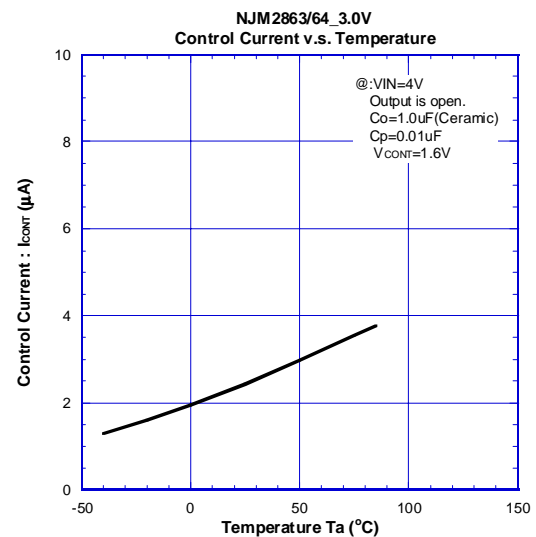
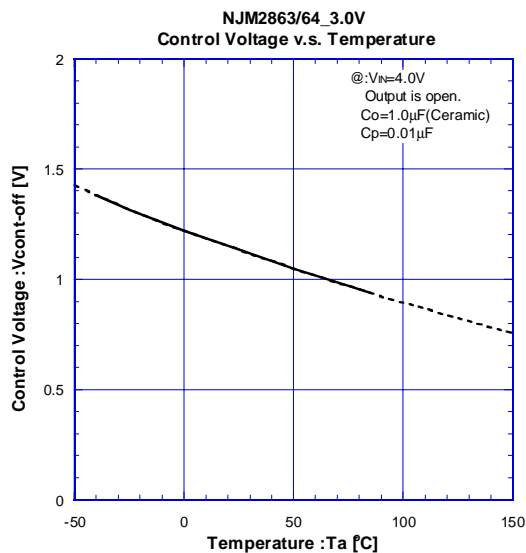
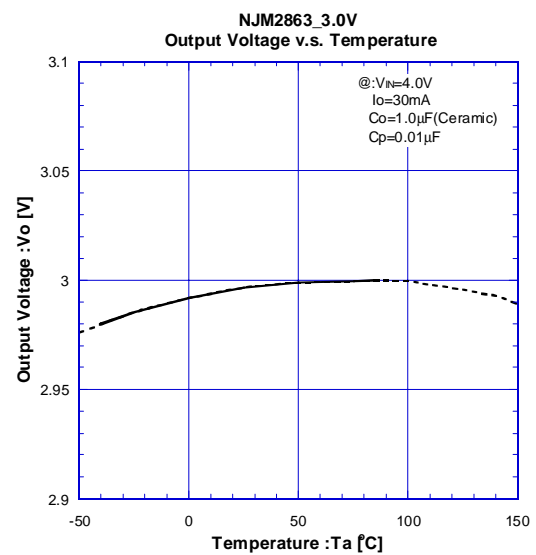
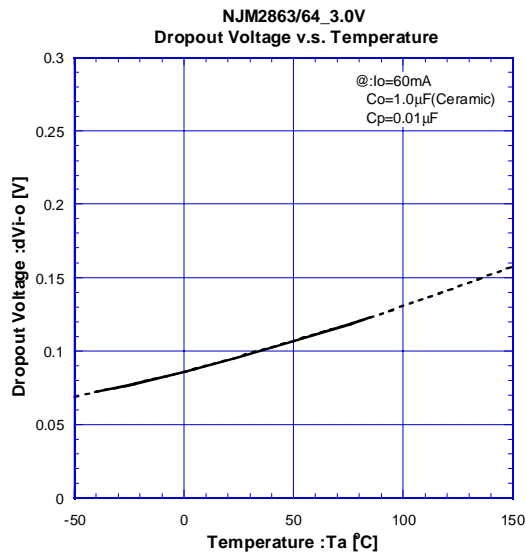
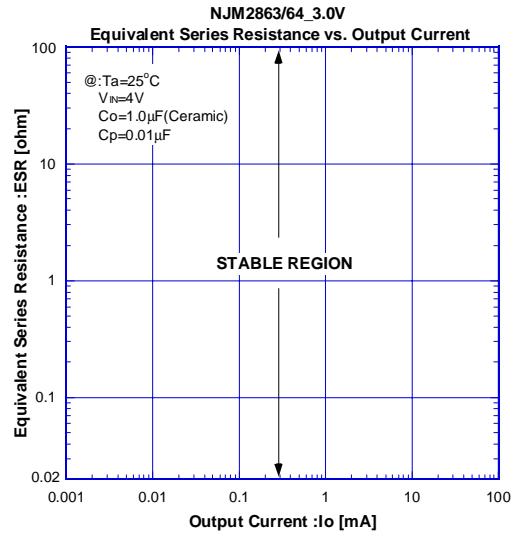
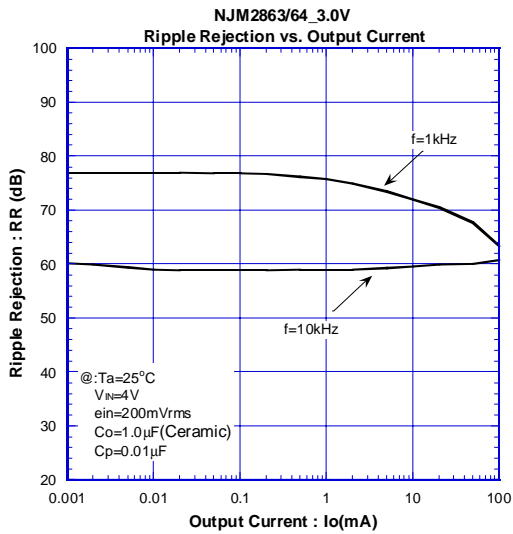



## ■ ELECTRICAL CHARACTERISTICS

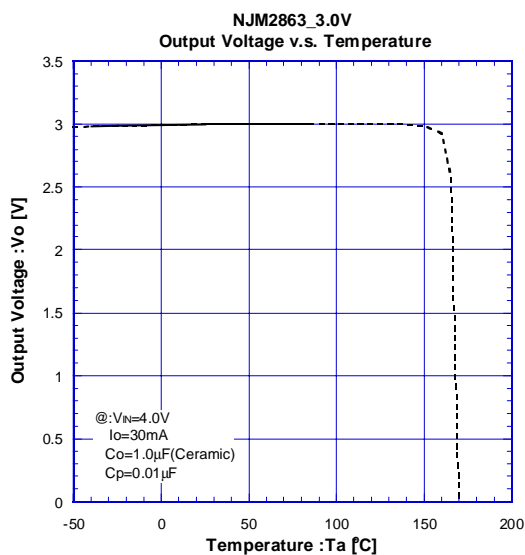
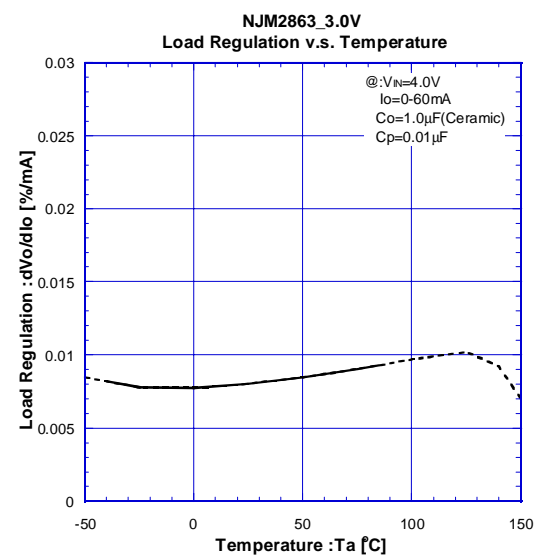
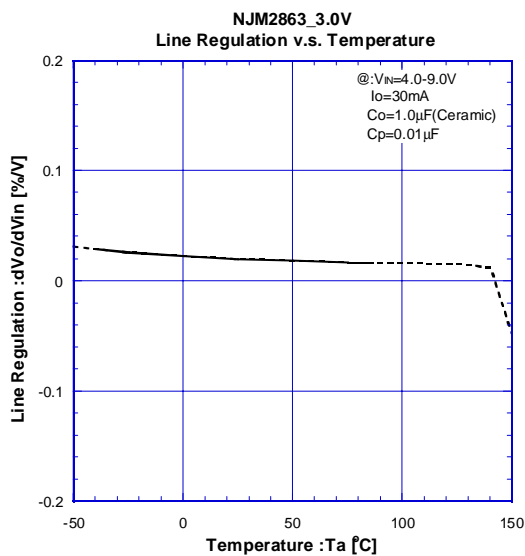
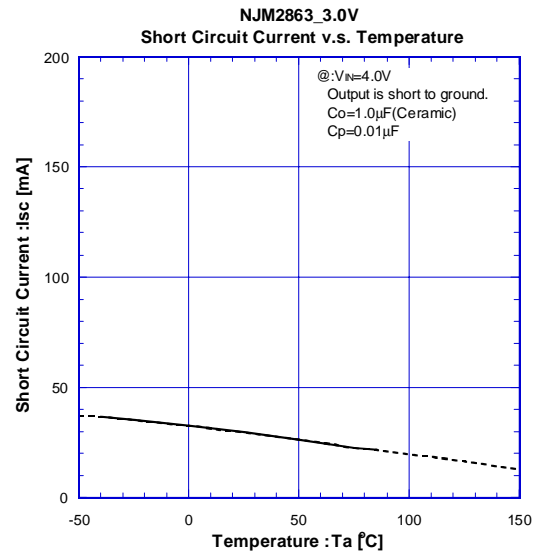
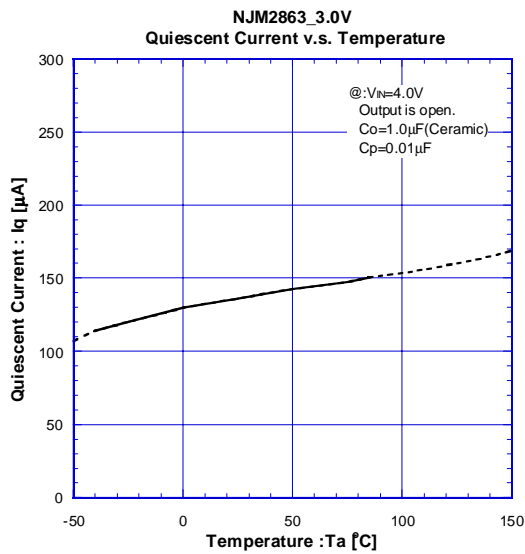

# NJM2863/64

## ELECTRICAL CHARACTERISTICS

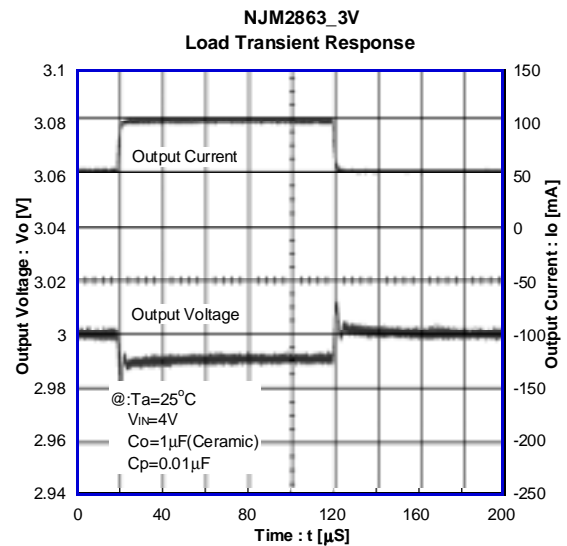
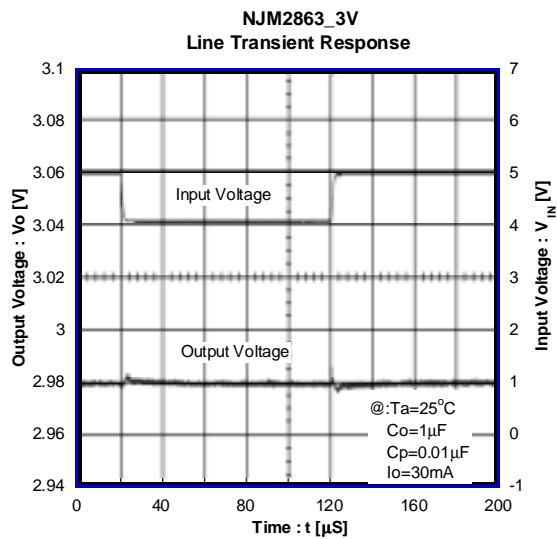
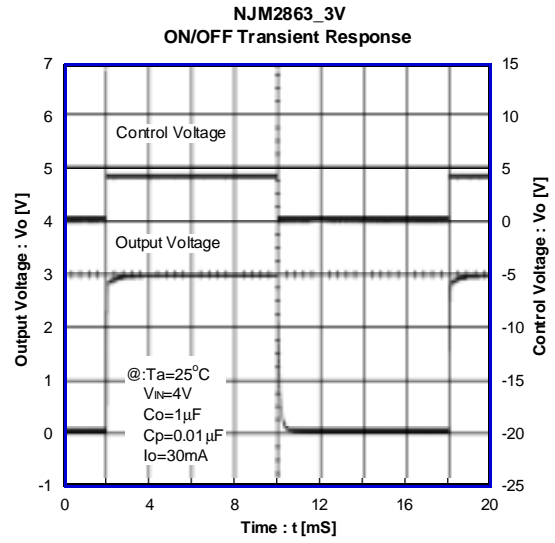
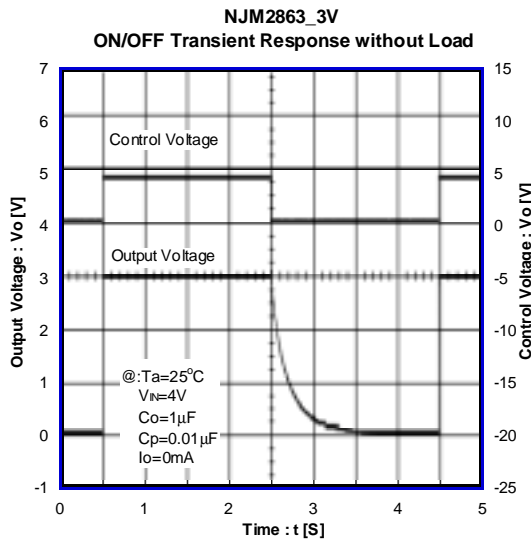

[CAUTION]  
The specifications on this databook are only given for information, without any guarantee as regards either mistakes or omissions. The application circuits in this databook are described only to show representative usages of the product and not intended for the guarantee or permission of any right including the industrial rights.