



ON Semiconductor®

<http://onsemi.com>

L88M05T

Monolithic Linear IC

17V, 5V / 0.5A Low Dropout Voltage Regulator

Overview

The L88M05T is low dropout voltage regulator IC with output current of 0.5 A. Because they can operate with a low input-output voltage difference, they contribute to smaller and more efficient set power supplies, and are optimum for audio-visual and office automation equipment.

Functions

- Output voltage : 5V
- 500 mA output current
- Low minimum input-output voltage differential (0.4V typ) enables to save energy and miniaturize transformer size.
- Set size can be miniaturized with compact TP-3H power package.
- Surface mounting on board permits allowable power dissipation to be raised.
- Enhanced mount flexibility with range of formed products.

Specifications

Maximum Ratings at $T_a = 25^\circ\text{C}$

| Parameter | Symbol | Conditions | Ratings | Unit |
|--|----------------------|--|-------------|--------------------|
| Input voltage | $V_{IN \text{ max}}$ | | 18 | V |
| Allowable power dissipation | $P_d \text{ max}$ | $T_a \leq 25^\circ\text{C}$, no heat sink | 1 | W |
| | | $T_c = 25^\circ\text{C}$, with infinite heat sink | 6.25 | W |
| Thermal resistance (junction-atmosphere) | θ_{j-a} | | 125 | $^\circ\text{C/W}$ |
| Thermal resistance (junction-to-case) | θ_{j-c} | | 20 | $^\circ\text{C/W}$ |
| Operating temperature | T_{opr} | | -20 to +85 | $^\circ\text{C}$ |
| Storage temperature | T_{stg} | | -55 to +150 | $^\circ\text{C}$ |

Stresses exceeding Maximum Ratings may damage the device. Maximum Ratings are stress ratings only. Functional operation above the Recommended Operating Conditions is not implied. Extended exposure to stresses above the Recommended Operating Conditions may affect device reliability.

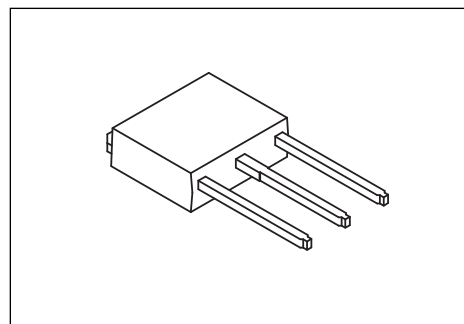

TP3H

ORDERING INFORMATION

See detailed ordering and shipping information on page 8 of this data sheet.

L88M00T Series

Pin Assignment

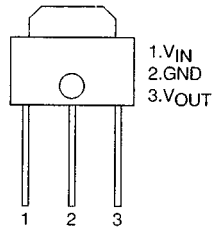

Top view

Operating Conditions at $T_a = 25\text{ }^\circ\text{C}$

| Parameter | Symbol | Conditions | Ratings | Unit |
|----------------|-----------|------------|-----------|------|
| Input voltage | V_{IN} | | 5.8 to 17 | V |
| Output current | I_{OUT} | | 0 to 500 | mA |

Operating Characteristics at $T_j = 25\text{ }^\circ\text{C}$, $V_{IN} = 8\text{ V}$, $I_O = 500\text{ mA}$, $C_{OUT} = 100\text{ }\mu\text{F}$, $C_{IN} = 1\text{ }\mu\text{F}$, see specified Test Circuit.

| Parameter | Symbol | Conditions | min | typ | max | Unit |
|---|-----------------------------|--|------|-----------|------|----------------------------|
| Output voltage | V_{OUT} | | 4.85 | 5.0 | 5.15 | V |
| Dropout voltage | V_{DROP1} | | | 0.4 | 0.6 | V |
| | V_{DROP2} | $I_O = 150\text{ mA}$ | | 0.2 | 0.3 | V |
| Line regulation | ΔV_{OLN} | 5.8 V % V_{IN} % 17 V | | 10 | 50 | mV |
| Load regulation | ΔV_{OLD} | 5 mA % I_{OUT} % 500 mA | | 30 | 100 | mV |
| Peak output current | I_{OP} | | 600 | 900 | | mA |
| Output short-circuit current | I_{OSC} | | | 100 | 300 | mA |
| Quiescent current | I_{Q1} | $I_{OUT} = 0$ | | 2.0 | 5.0 | mA |
| | I_{Q2} | | | 24 | 50 | mA |
| Output noise voltage | V_{NO} | 10 Hz % f % 100 kHz | | 40 | | μVrms |
| Temperature coefficient of output voltage | $\Delta V_{OUT}/\Delta T_j$ | $T_j = 25\text{ to }125\text{ }^\circ\text{C}$ | | ± 0.5 | | $\text{mV}/^\circ\text{C}$ |
| Ripple rejection | Rrej | f = 120 Hz, 6 V % V_{IN} % 17 V | | 65 | | dB |

L88M05T

Package Dimensions

unit : mm

IPAK / TP3H
CASE 369AF
ISSUE A

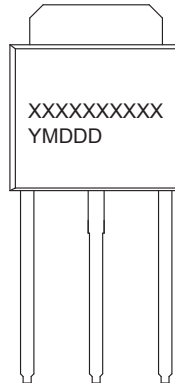
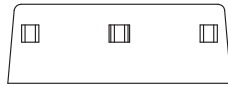
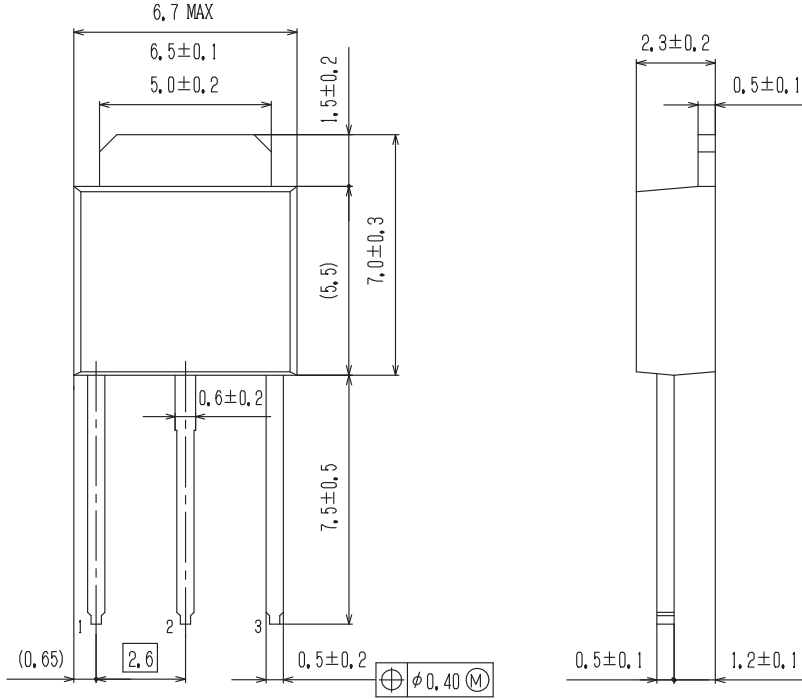

GENERIC MARKING DIAGRAM*

XXXXXX = Specific Device Code
 Y = Year
 M = Month
 DDD = Additional Traceability Data

*This information is generic. Please refer to device data sheet for actual part marking. Pb-Free indicator, "G" or microdot "▪", may or may not be present.

SOLDERING FOOTPRINT*

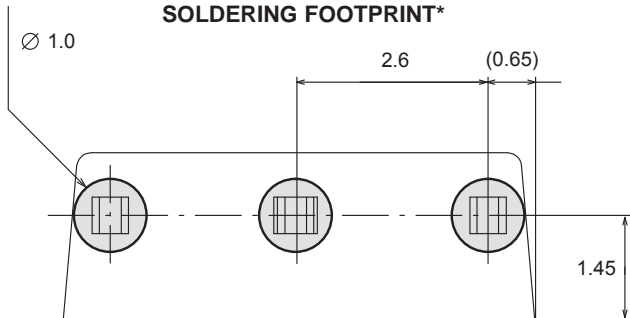

NOTE: The measurements are not to guarantee but for reference only.

(Unit: mm)

| |
|--------------|
| Package name |
| TP3H |

○ Through Hole Area

*For additional information on our Pb-Free strategy and soldering details, please download the ON Semiconductor Soldering and Mounting Techniques Reference Manual, SOLDERRM/D.

L88M00T Series

Equivalent Circuit Block Diagram (Common to L88M00T Series)

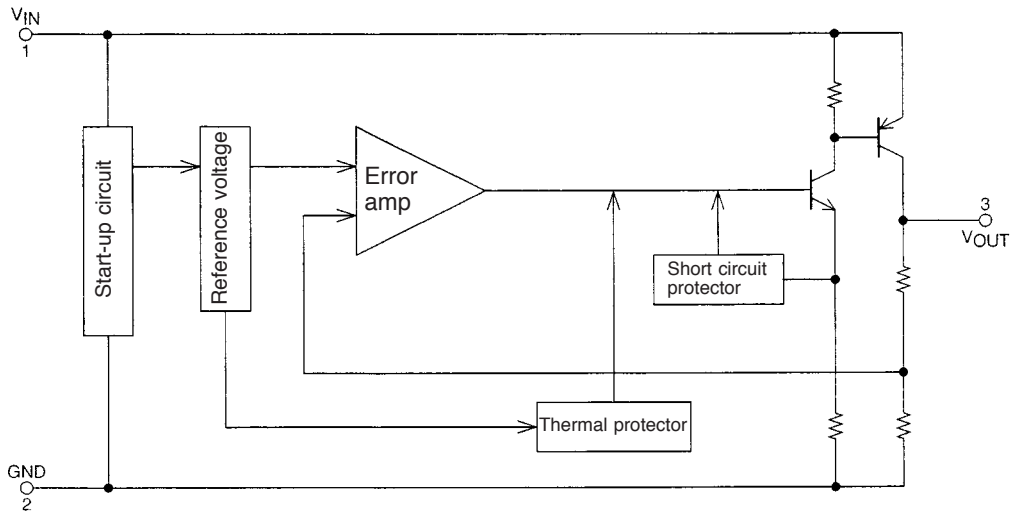

A10243

Test Circuit (Common to L88M00T Series)

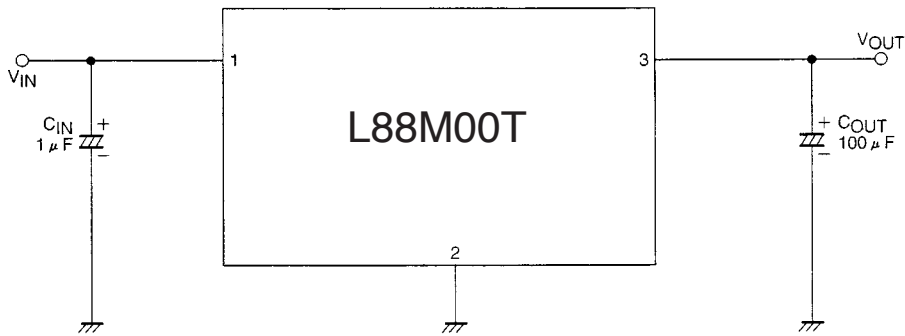

A10244

- Notes:
1. To ensure operational stability, C_{IN} and C_{OUT} should be placed as close to the IC as possible.
 2. Because the output capacitor C_{OUT} is set at over $100 \mu\text{F}$ to prevent oscillation at low temperatures, a capacitor that exhibits little change in capacity with temperature variations should be used (such as a tantalum capacitor).
 3. When V_{IN} is minus (-) and GND is plus (+) (reversed connection), excessive current flow will occur.

L88M00T Series

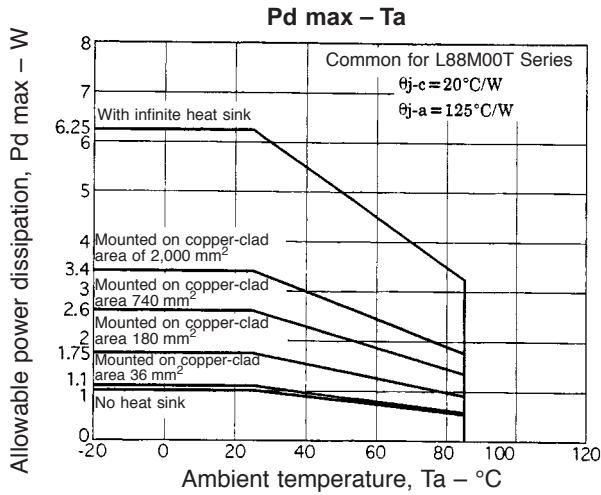

- The allowable power dissipation is 1.0 W ($T_a = 25^\circ\text{C}$) with no fin attached, but when mounted on a hybrid IC board or printed circuit board, high allowable power dissipation is achieved, despite the compact package. The graph below depicts the relationship between the copper-clad area and allowable power dissipation when mounted on a glass epoxy board ($50 \times 50 \times 0.8 \text{ mm}^3$) with a copper thickness of $18 \mu\text{m}$.

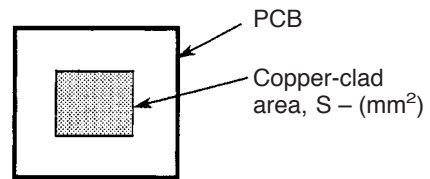
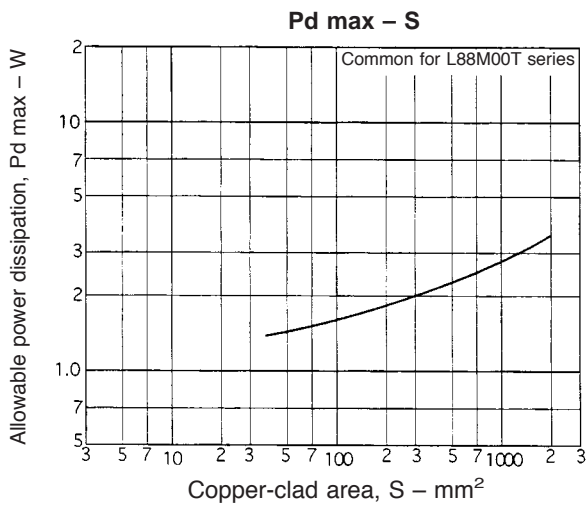

- Pd is the value for when the solder on the surface of the IC heat sink has melted completely and the surface mount is horizontal.
- Please be advised that the flow solder application system (full-heat method) cannot be recommended.

Lead Formings

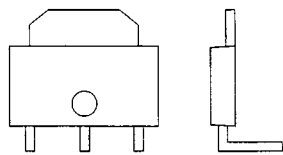

LR forming

A10245

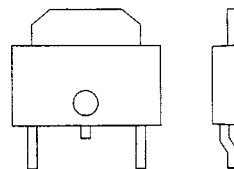

FA forming

A10246

L88M00T Series

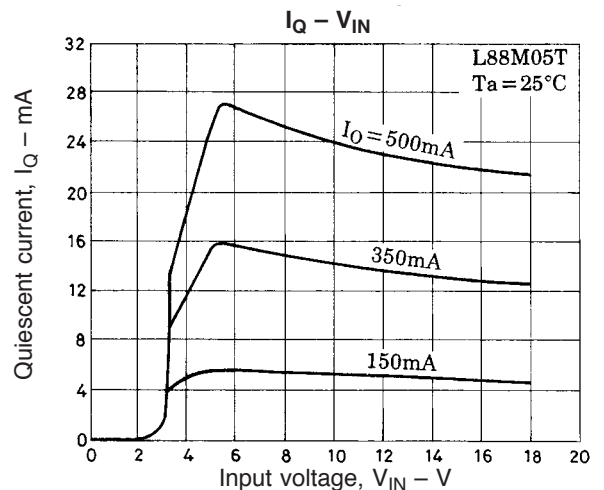
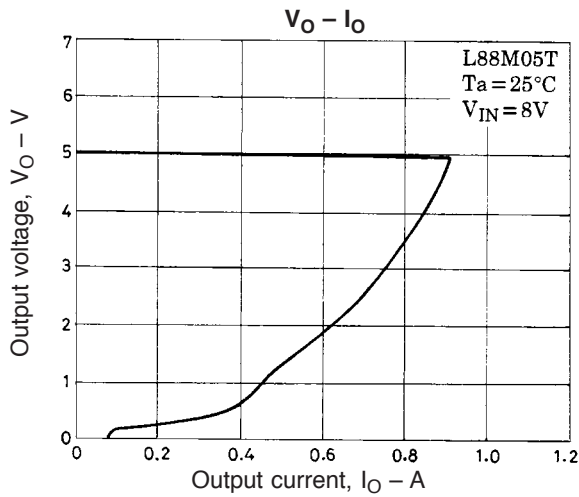
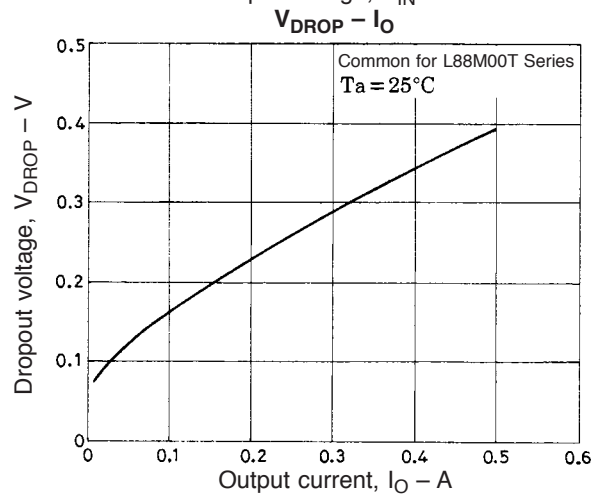
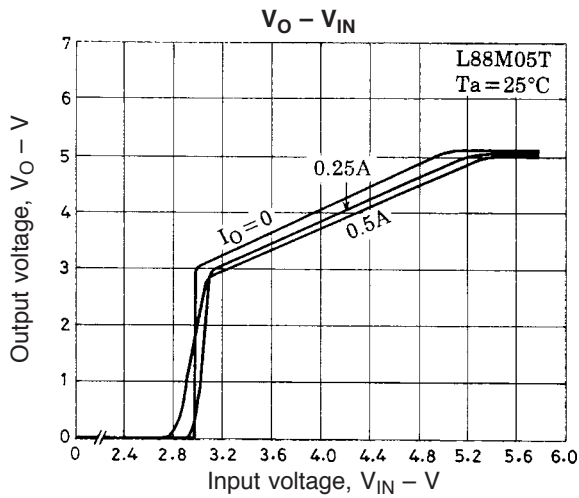
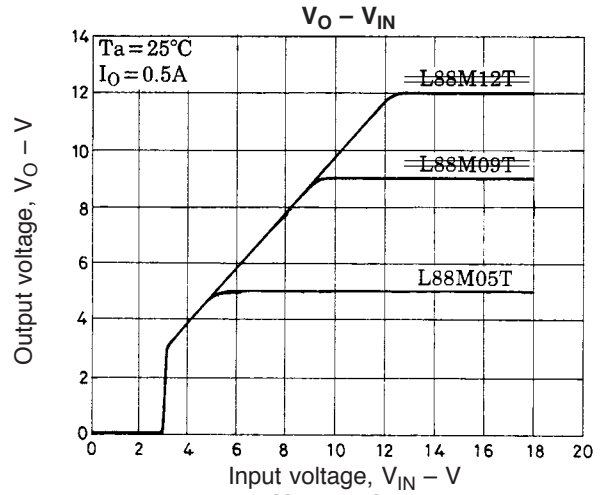

L88M00T Series

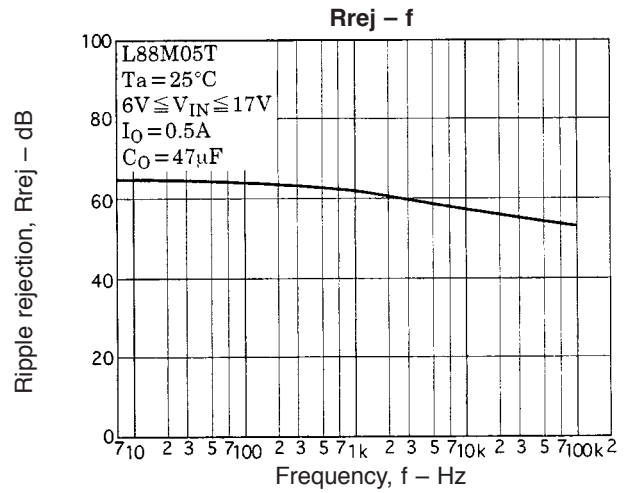
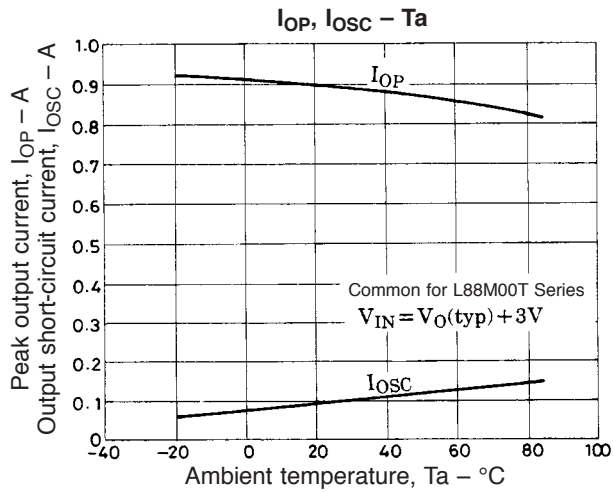
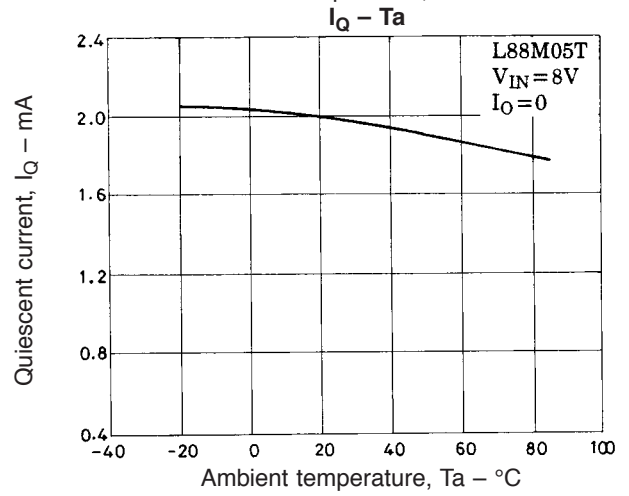
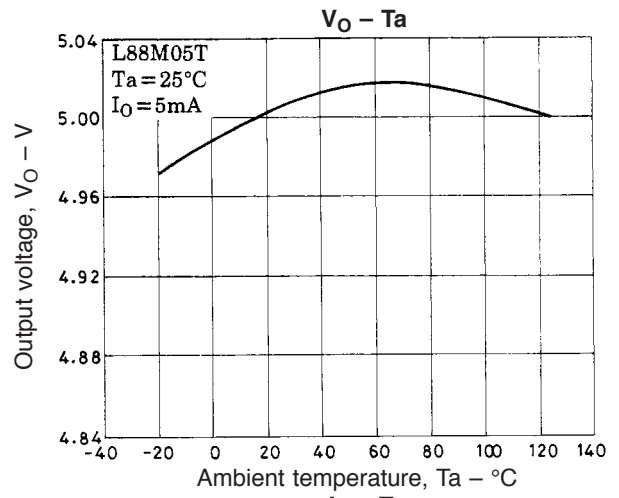
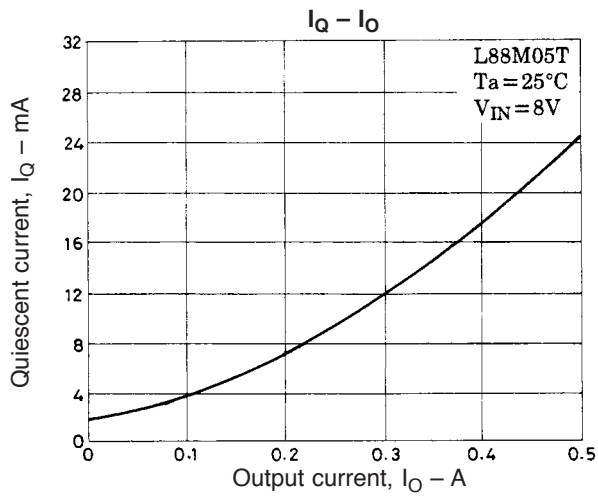

L88M05T

ORDERING INFORMATION

| Device | Package | Shipping (Qty / Packing) |
|---------------|-------------------|--------------------------|
| L88M05T-E | TP3H (Pb-Free) | 500 / Bulk Bag |
| L88M05TL-FA-E | TP3H (Pb-Free) | 500 / Bulk Bag |
| L88M05TLL-E | TP3H (Pb-Free) | 500 / Bulk Bag |
| L88M05TL-LR-E | TP3H (Pb-Free) | 500 / Bulk Bag |
| L88M05TL-TL-E | TP3H (Pb-Free) | 700 / Tape & Reel |
| L88M05T-TL-E | TP3H (Pb-Free) | 700 / Tape & Reel |

ON Semiconductor and the ON logo are registered trademarks of Semiconductor Components Industries, LLC (SCILLC). SCILLC owns the rights to a number of patents, trademarks, copyrights, trade secrets, and other intellectual property. A listing of SCILLC's product/patent coverage may be accessed at www.onsemi.com/site/pdf/Patent-Marking.pdf. SCILLC reserves the right to make changes without further notice to any products herein. SCILLC makes no warranty, representation or guarantee regarding the suitability of its products for any particular purpose, nor does SCILLC assume any liability arising out of the application or use of any product or circuit, and specifically disclaims any and all liability, including without limitation special, consequential or incidental damages. "Typical" parameters which may be provided in SCILLC data sheets and/or specifications can and do vary in different applications and actual performance may vary over time. All operating parameters, including "Typicals" must be validated for each customer application by customer's technical experts. SCILLC does not convey any license under its patent rights nor the rights of others. SCILLC products are not designed, intended, or authorized for use as components in systems intended for surgical implant into the body, or other applications intended to support or sustain life, or for any other application in which the failure of the SCILLC product could create a situation where personal injury or death may occur. Should Buyer purchase or use SCILLC products for any such unintended or unauthorized application, Buyer shall indemnify and hold SCILLC and its officers, employees, subsidiaries, affiliates, and distributors harmless against all claims, costs, damages, and expenses, and reasonable attorney fees arising out of, directly or indirectly, any claim of personal injury or death associated with such unintended or unauthorized use, even if such claim alleges that SCILLC was negligent regarding the design or manufacture of the part. SCILLC is an Equal Opportunity/Affirmative Action Employer. This literature is subject to all applicable copyright laws and is not for resale in any manner.