

### General Description

- Trench Power AlphaMOS-II technology
- Low  $R_{DS(ON)}$
- Low  $C_{iss}$  and  $C_{rss}$
- High Current Capability
- RoHS and Halogen Free Compliant

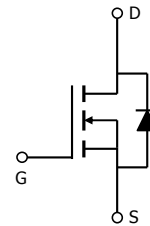
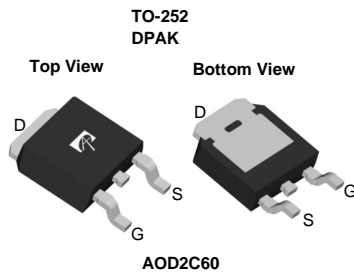
### Applications

- General Lighting for LED and CCFL
- AC/DC Power supplies for Industrial, Consumer, and Telecom

### Product Summary

|                      |                |
|----------------------|----------------|
| $V_{DS} @ T_{j,max}$ | 700V           |
| $I_{DM}$             | 8A             |
| $R_{DS(ON),max}$     | < 3.3 $\Omega$ |
| $Q_{g,typ}$          | 5.1nC          |
| $E_{oss} @ 400V$     | 1.2 $\mu$ J    |

100% UIS Tested  
 100%  $R_g$  Tested



| Orderable Part Number | Package Type | Form        | Minimum Order Quantity |
|-----------------------|--------------|-------------|------------------------|
| AOD2C60               | TO-252       | Tape & Reel | 2500                   |

### Absolute Maximum Ratings $T_A=25^\circ\text{C}$ unless otherwise noted

| Parameter                                                                    | Symbol         | Maximum                         | Units            |
|------------------------------------------------------------------------------|----------------|---------------------------------|------------------|
| Drain-Source Voltage                                                         | $V_{DS}$       | 600                             | V                |
| Gate-Source Voltage                                                          | $V_{GS}$       | $\pm 30$                        | V                |
| Continuous Drain Current                                                     | $I_D$          | $T_C=25^\circ\text{C}$          | 2                |
|                                                                              |                | $T_C=100^\circ\text{C}$         | 1.6              |
| Pulsed Drain Current <sup>C</sup>                                            | $I_{DM}$       | 8                               | A                |
| Avalanche Current <sup>C</sup> $L=1\text{mH}$                                | $I_{AR}$       | 2                               | A                |
| Repetitive avalanche energy <sup>C</sup>                                     | $E_{AR}$       | 2                               | mJ               |
| Single pulsed avalanche energy <sup>H</sup>                                  | $E_{AS}$       | 87                              | mJ               |
| MOSFET dv/dt ruggedness                                                      | dv/dt          | 100                             | V/ns             |
| Peak diode recovery dv/dt                                                    |                | 20                              |                  |
| Power Dissipation <sup>B</sup>                                               | $P_D$          | $T_C=25^\circ\text{C}$          | 52               |
|                                                                              |                | Derate above $25^\circ\text{C}$ | 0.4              |
| Junction and Storage Temperature Range                                       | $T_J, T_{STG}$ | -55 to 150                      | $^\circ\text{C}$ |
| Maximum lead temperature for soldering purpose, 1/8" from case for 5 seconds | $T_L$          | 300                             | $^\circ\text{C}$ |

### Thermal Characteristics

| Parameter                                  | Symbol          | Typical | Maximum | Units                     |
|--------------------------------------------|-----------------|---------|---------|---------------------------|
| Maximum Junction-to-Ambient <sup>A,D</sup> | $R_{\theta JA}$ | 45      | 55      | $^\circ\text{C}/\text{W}$ |
| Maximum Case-to-sink <sup>A</sup>          | $R_{\theta CS}$ | -       | 0.5     | $^\circ\text{C}/\text{W}$ |
| Maximum Junction-to-Case <sup>D,F</sup>    | $R_{\theta JC}$ | 2       | 2.4     | $^\circ\text{C}/\text{W}$ |

**Electrical Characteristics (T<sub>J</sub>=25°C unless otherwise noted)**

| Symbol                             | Parameter                                                 | Conditions                                                                           | Min | Typ  | Max  | Units |    |
|------------------------------------|-----------------------------------------------------------|--------------------------------------------------------------------------------------|-----|------|------|-------|----|
| <b>STATIC PARAMETERS</b>           |                                                           |                                                                                      |     |      |      |       |    |
| BV <sub>DSS</sub>                  | Drain-Source Breakdown Voltage                            | I <sub>D</sub> =250μA, V <sub>GS</sub> =0V, T <sub>J</sub> =25°C                     | 600 |      |      | V     |    |
|                                    |                                                           | I <sub>D</sub> =250μA, V <sub>GS</sub> =0V, T <sub>J</sub> =150°C                    |     | 700  |      |       |    |
| BV <sub>DSS</sub> /ΔT <sub>J</sub> | Breakdown Voltage Temperature Coefficient                 | I <sub>D</sub> =250μA, V <sub>GS</sub> =0V                                           |     | 0.59 |      | V/°C  |    |
| I <sub>DSS</sub>                   | Zero Gate Voltage Drain Current                           | V <sub>DS</sub> =600V, V <sub>GS</sub> =0V                                           |     |      | 1    | μA    |    |
|                                    |                                                           | V <sub>DS</sub> =480V, T <sub>J</sub> =125°C                                         |     |      | 10   |       |    |
| I <sub>GSS</sub>                   | Gate-Body leakage current                                 | V <sub>DS</sub> =0V, V <sub>GS</sub> =±30V                                           |     |      | ±100 | nA    |    |
| V <sub>GS(th)</sub>                | Gate Threshold Voltage                                    | V <sub>DS</sub> =5V, I <sub>D</sub> =250μA                                           | 3   | 4.5  | 5    | V     |    |
| R <sub>DS(ON)</sub>                | Static Drain-Source On-Resistance                         | V <sub>GS</sub> =10V, I <sub>D</sub> =0.5A                                           |     | 2.7  | 3.3  | Ω     |    |
| g <sub>FS</sub>                    | Forward Transconductance                                  | V <sub>DS</sub> =40V, I <sub>D</sub> =1A                                             |     | 1.8  |      | S     |    |
| V <sub>SD</sub>                    | Diode Forward Voltage                                     | I <sub>S</sub> =1A, V <sub>GS</sub> =0V                                              |     | 0.81 | 1    | V     |    |
| I <sub>S</sub>                     | Maximum Body-Diode Continuous Current                     |                                                                                      |     |      | 2    | A     |    |
| I <sub>SM</sub>                    | Maximum Body-Diode Pulsed Current <sup>C</sup>            |                                                                                      |     |      | 8    | A     |    |
| <b>DYNAMIC PARAMETERS</b>          |                                                           |                                                                                      |     |      |      |       |    |
| C <sub>iss</sub>                   | Input Capacitance                                         | V <sub>GS</sub> =0V, V <sub>DS</sub> =100V, f=1MHz                                   |     | 304  |      | pF    |    |
| C <sub>oss</sub>                   | Output Capacitance                                        |                                                                                      |     |      | 15   |       | pF |
| C <sub>o(er)</sub>                 | Effective output capacitance, energy related <sup>I</sup> | V <sub>GS</sub> =0V, V <sub>DS</sub> =0 to 480V, f=1MHz                              |     | 15   |      | pF    |    |
| C <sub>o(tr)</sub>                 | Effective output capacitance, time related <sup>J</sup>   |                                                                                      |     |      | 22   |       | pF |
| C <sub>rss</sub>                   | Reverse Transfer Capacitance                              | V <sub>GS</sub> =0V, V <sub>DS</sub> =100V, f=1MHz                                   |     | 1    |      | pF    |    |
| R <sub>g</sub>                     | Gate resistance                                           | f=1MHz                                                                               |     | 6.8  |      | Ω     |    |
| <b>SWITCHING PARAMETERS</b>        |                                                           |                                                                                      |     |      |      |       |    |
| Q <sub>g</sub>                     | Total Gate Charge                                         | V <sub>GS</sub> =10V, V <sub>DS</sub> =480V, I <sub>D</sub> =2A                      |     | 5.1  | 10   | nC    |    |
| Q <sub>gs</sub>                    | Gate Source Charge                                        |                                                                                      |     |      | 2.3  |       | nC |
| Q <sub>gd</sub>                    | Gate Drain Charge                                         |                                                                                      |     |      | 1    |       | nC |
| t <sub>D(on)</sub>                 | Turn-On DelayTime                                         | V <sub>GS</sub> =10V, V <sub>DS</sub> =300V, I <sub>D</sub> =2A, R <sub>G</sub> =25Ω |     | 18   |      | ns    |    |
| t <sub>r</sub>                     | Turn-On Rise Time                                         |                                                                                      |     |      | 13   |       | ns |
| t <sub>D(off)</sub>                | Turn-Off DelayTime                                        |                                                                                      |     |      | 21   |       | ns |
| t <sub>f</sub>                     | Turn-Off Fall Time                                        |                                                                                      |     |      | 16   |       | ns |
| t <sub>rr</sub>                    | Body Diode Reverse Recovery Time                          | I <sub>F</sub> =2A, di/dt=100A/μs, V <sub>DS</sub> =100V                             |     | 224  |      | ns    |    |
| Q <sub>rr</sub>                    | Body Diode Reverse Recovery Charge                        | I <sub>F</sub> =2A, di/dt=100A/μs, V <sub>DS</sub> =100V                             |     | 1.3  |      | μC    |    |

A. The value of R<sub>qJA</sub> is measured with the device in a still air environment with T<sub>A</sub>=25°C.

B. The power dissipation P<sub>D</sub> is based on T<sub>J(MAX)</sub>=150°C in a TO252 package, using junction-to-case thermal resistance, and is more useful in setting the upper dissipation limit for cases where additional heatsinking is used.

C. Repetitive rating, pulse width limited by junction temperature T<sub>J(MAX)</sub>=150°C.

D. The R<sub>qJA</sub> is the sum of the thermal impedance from junction to case R<sub>qJC</sub> and case to ambient.

E. The static characteristics in Figures 1 to 6 are obtained using <300 ms pulses, duty cycle 0.5% max.

F. These curves are based on the junction-to-case thermal impedance which is measured with the device mounted to a large heatsink, assuming a maximum junction temperature of T<sub>J(MAX)</sub>=150°C.

G. These tests are performed with the device mounted on 1 in<sup>2</sup> FR-4 board with 2oz. Copper, in a still air environment with T<sub>A</sub>=25°C.

H. L=60mH, I<sub>AS</sub>=1.7A, V<sub>DD</sub>=150V, R<sub>G</sub>=10Ω, Starting T<sub>J</sub>=25°C.

I. C<sub>o(er)</sub> is a fixed capacitance that gives the same stored energy as C<sub>oss</sub> while V<sub>DS</sub> is rising from 0 to 80% V<sub>(BR)DSS</sub>.

J. C<sub>o(tr)</sub> is a fixed capacitance that gives the same charging time as C<sub>oss</sub> while V<sub>DS</sub> is rising from 0 to 80% V<sub>(BR)DSS</sub>.

THIS PRODUCT HAS BEEN DESIGNED AND QUALIFIED FOR THE CONSUMER MARKET. APPLICATIONS OR USES AS CRITICAL COMPONENTS IN LIFE SUPPORT DEVICES OR SYSTEMS ARE NOT AUTHORIZED. AOS DOES NOT ASSUME ANY LIABILITY ARISING OUT OF SUCH APPLICATIONS OR USES OF ITS PRODUCTS. AOS RESERVES THE RIGHT TO IMPROVE PRODUCT DESIGN, FUNCTIONS AND RELIABILITY WITHOUT NOTICE.

**TYPICAL ELECTRICAL AND THERMAL CHARACTERISTICS**

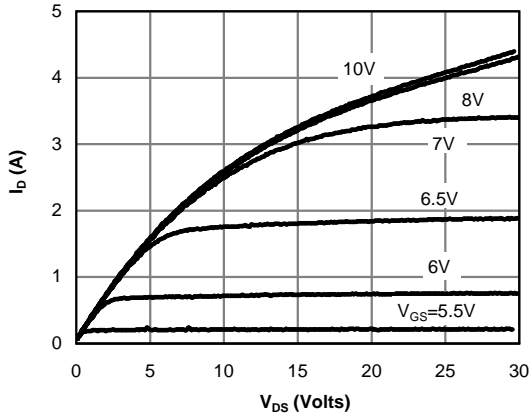


Figure 1: On-Region Characteristics

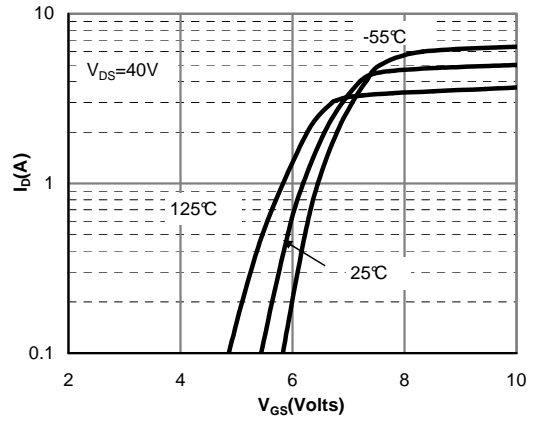


Figure 2: Transfer Characteristics

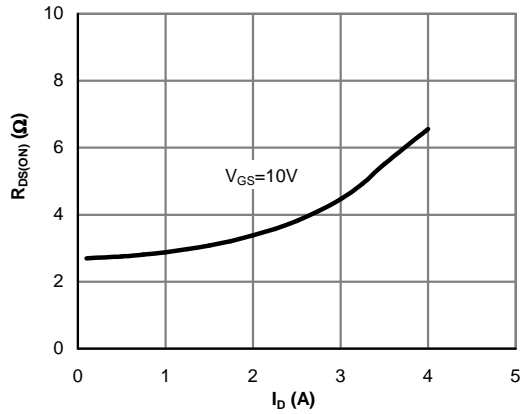


Figure 3: On-Resistance vs. Drain Current and Gate Voltage

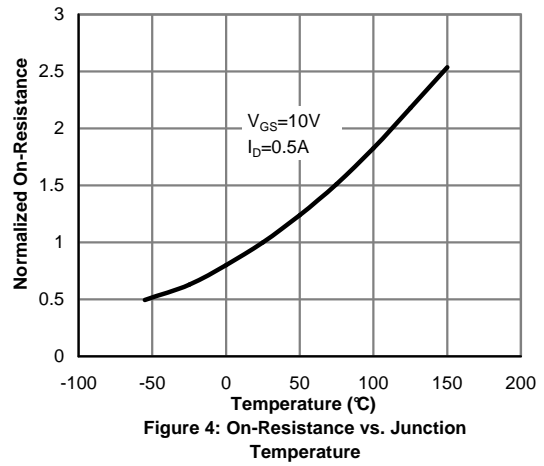


Figure 4: On-Resistance vs. Junction Temperature

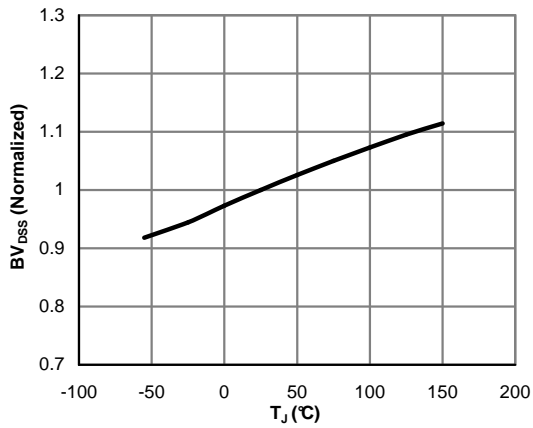


Figure 5: Break Down vs. Junction Temperature

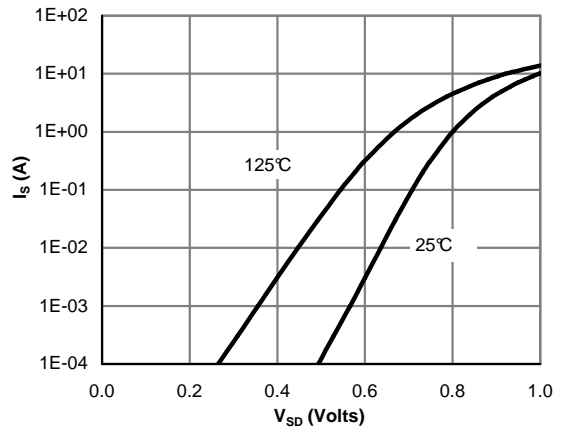


Figure 6: Body-Diode Characteristics

**TYPICAL ELECTRICAL AND THERMAL CHARACTERISTICS**

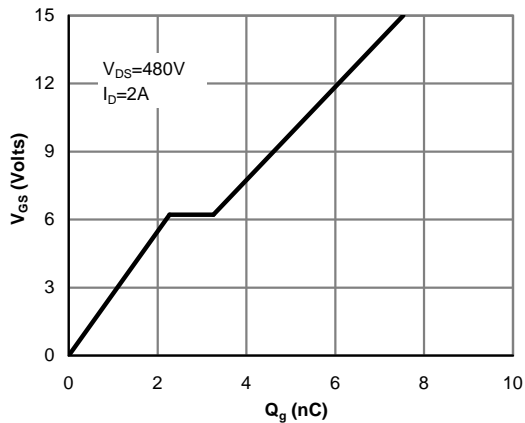


Figure 7: Gate-Charge Characteristics

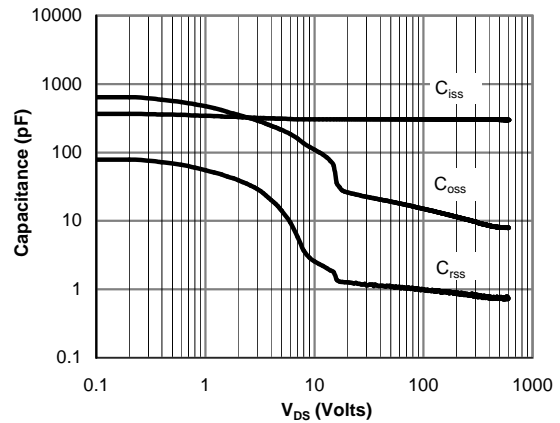


Figure 8: Capacitance Characteristics

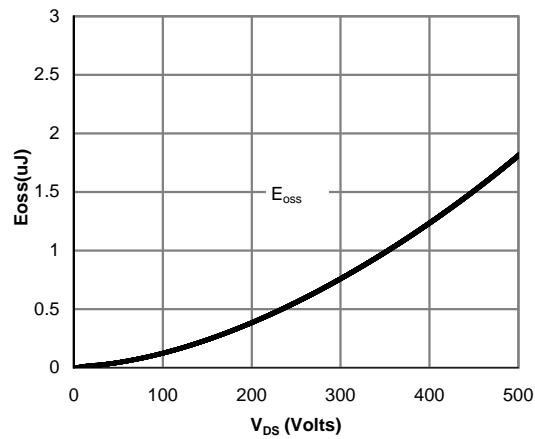


Figure 9:  $C_{oss}$  stored Energy

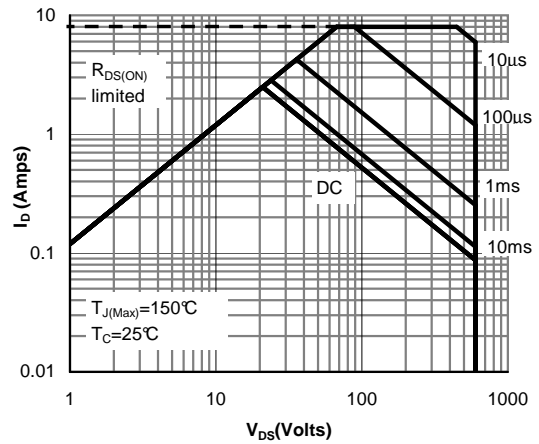


Figure 10: Maximum Forward Biased Safe Operating Area (Note F)

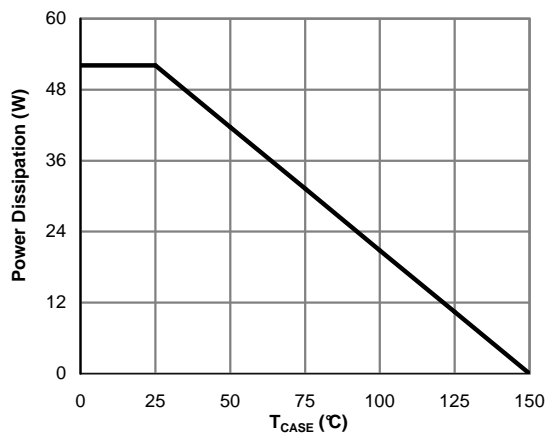


Figure 11: Power De-rating (Note B)

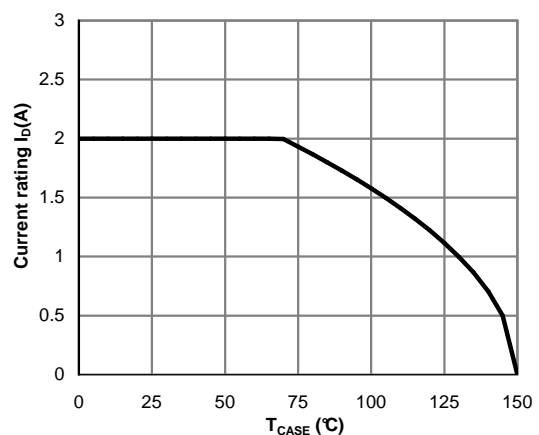
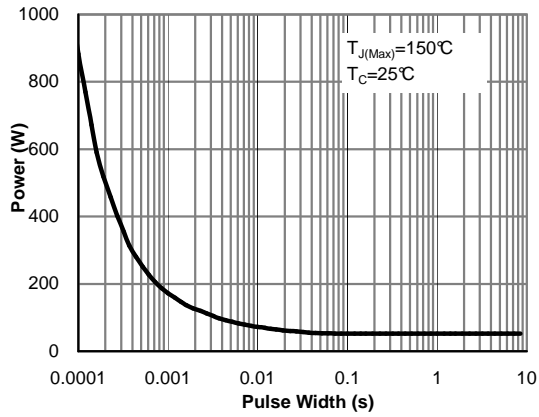
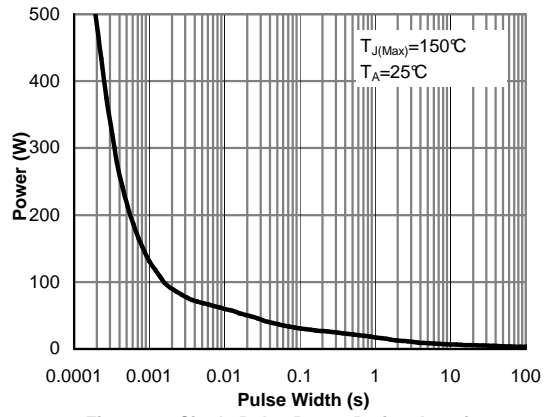


Figure 12: Current De-rating (Note F)

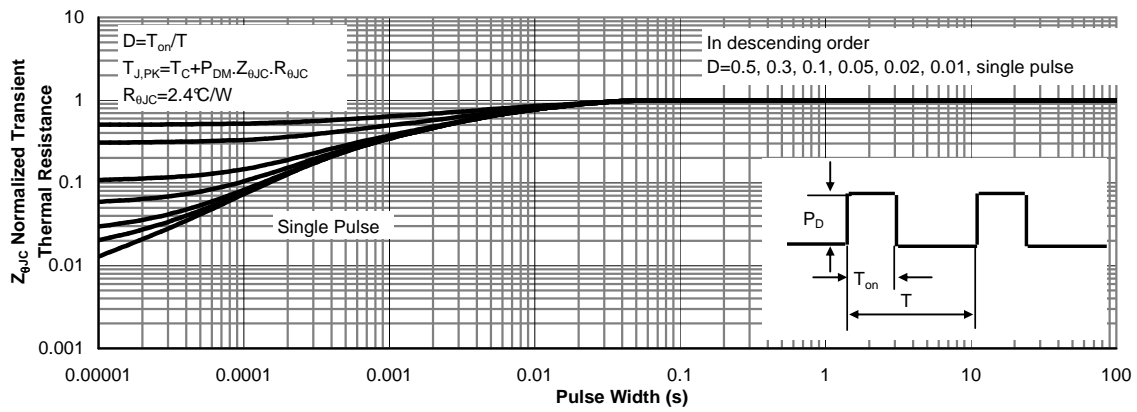
**TYPICAL ELECTRICAL AND THERMAL CHARACTERISTICS**



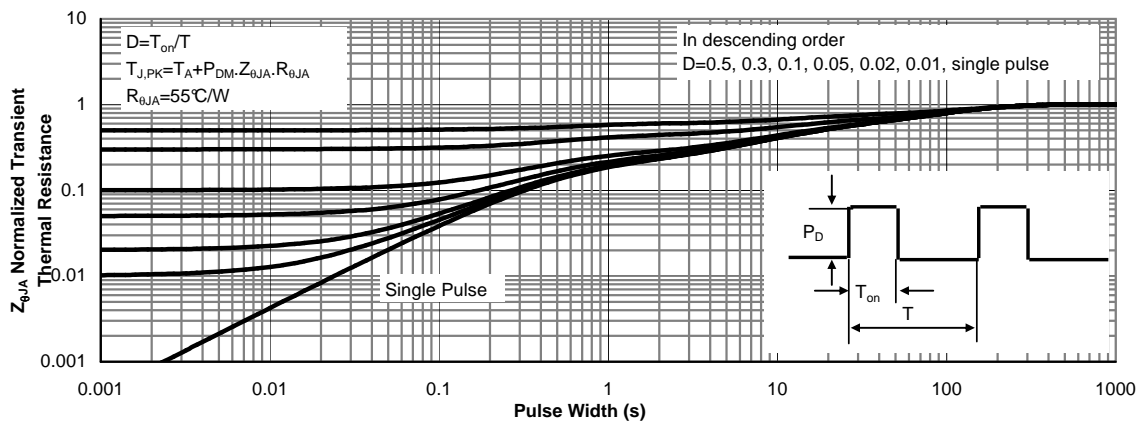
**Figure 13: Single Pulse Power Rating Junction-to-Case (Note F)**



**Figure 14: Single Pulse Power Rating Junction-to-Ambient (Note G)**

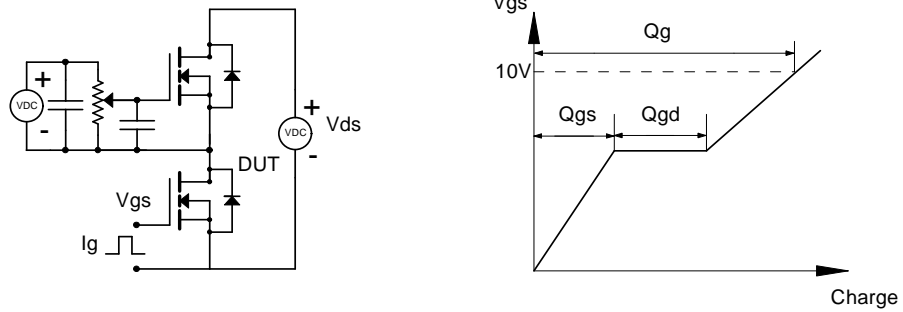


**Figure 15: Normalized Maximum Transient Thermal Impedance (Note F)**

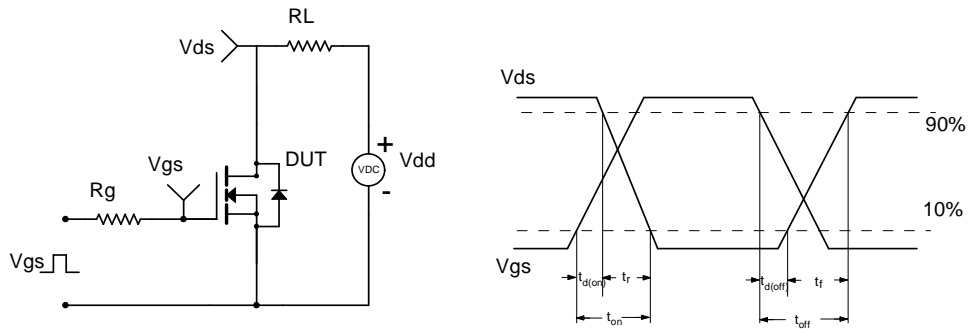


**Figure 16: Normalized Maximum Transient Thermal Impedance (Note G)**

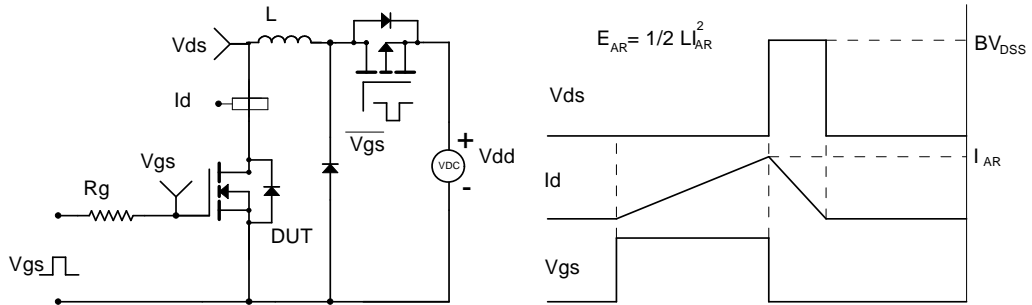
Gate Charge Test Circuit & Waveform



Resistive Switching Test Circuit & Waveforms



Unclamped Inductive Switching (UIS) Test Circuit & Waveforms



Diode Recovery Test Circuit & Waveforms

