

1	Connection for Standard Use	CBS-16
2	Wiring Input/Output Pin	CBS-16
2.1	Wiring input pin	CBS-16
2.2	Wiring output pin	CBS-17
3	Function	CBS-18
3.1	Overcurrent protection	CBS-18
3.2	Overvoltage protection	CBS-18
3.3	Thermal protection	CBS-18
3.4	Remote ON/OFF	CBS-18
3.5	Remote sensing	CBS-18
3.6	Adjustable voltage range	CBS-19
3.7	Withstanding Voltage / Isolation Voltage	CBS-19
4	Series and Parallel Operation	CBS-20
4.1	Series operation	CBS-20
4.2	Redundancy operation	CBS-20
5	Cleaning	CBS-20
6	Safety Considerations	CBS-20
7	Options	CBS-20
7.1	Addition of a Heat sink(Optional:F□)	CBS-20

1 Connection for Standard Use

■ The power module needs input and output connections as shown in Fig. 1.1.

(Reference: 2 "Wiring Input/Output Pin")

■ Short the following pins to turn on the power module.

-VIN↔RC, +VOUT↔+S, and -VOUT↔-S

(Reference: 3.4 "Remote ON/OFF"
3.5 "Remote sensing")

■ Only DC voltage can be applied to CBS Series. Applying AC voltage will damage the power module.

■ The power module is designed for conduction cooling. Make sure that heat sinks, fans, etc. are used for heat dissipation. Refer to "Derating"

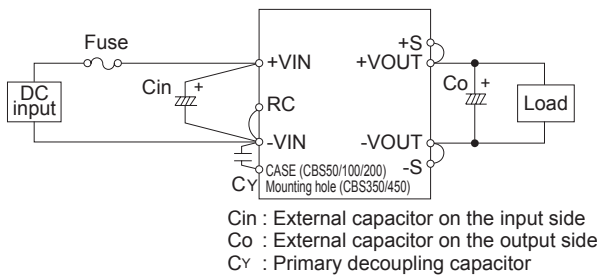

Fig.1.1 Connection for Standard Use

2 Wiring Input/Output Pin

2.1 Wiring input pin

(1) External fuse

■ The input circuit of CBS Series does not come with a built-in fuse. In order to protect the power module, a normal-blow fuse should be installed to +VIN.

■ When multiple modules get input voltage from a single front-end power supply, a normal-blow fuse must be installed to each module.

Table 2.1 Recommended Fuses (Normal-Blow Type)

Model	CBS5024	CBS10024	CBS20024		CBS35024
			1R8/2R5/03/05	12/15/24/28	
Rated current	6A	12A	20A	25A	30A
Model	CBS5048	CBS10048	CBS20048		CBS35048 CBS45048
			1R8/2R5/03/05	12/15/24/28/48	
Rated current	3A	6A	10A	12A	20A

(2) Noise Filter/Grounding Capacitor

■ A grounding capacitor C_Y must be used to reduce the line noise on the input line and stabilize the power module operation (Fig. 1.1). Note that resonance and inductance from the input line filter may cause the power module to become unstable.

■ An appropriate filter must be used if conformance to the conducted noise regulation is required or if surge voltage may be applied to the unit. Please consult us for more details.

■ Install a grounding capacitor C_Y of at least 4700 pF as close to the input pins as possible (within 50mm of the pins).

■ If the total capacitance of the grounding capacitor exceeds 15000 pF, the specified isolation voltage between input and output may not be satisfied. In this case, either reduce the capacitance of the grounding capacitor at the input or install a grounding capacitor to the output.

There is no maximum limit to capacitance C_Y when the power module is used with an isolation voltage of less than 500VAC (1 min.) between input and output.

(3) External Capacitor on the Input

■ An external capacitor C_{in} must be installed between +VIN and -VIN to reduce line noise and stabilize the power module operation (Fig. 1.1).

Capacitance	CBS50/100/20024: at least 68 μ F CBS35024: at least 220 μ F X 2 CBS50/100/20048: at least 33 μ F CBS35048: at least 68 μ F X 2 CBS45048: at least 68 μ F X 2
Tc=-20 to +100°C	Electrolytic or Ceramic capacitor
Tc=-40 to +100°C	Ceramic capacitor

■ The capacitor must be installed less than 50mm of the power module. As ripple current will flow through this capacitor, pay attention to the ripple current rating of the capacitor.

■ If the power module is to be turned ON/OFF directly with a switch, inductance from the input line will induce a surge voltage several times that of the input voltage and it may damage the power module. Make sure that the surge is absorbed, for example, by connecting an electrolytic capacitor between the input pins.

(4) Input Voltage Range/Input Current Range

■ Keep the input voltage ripple within the specifications below. Output ripple voltage will increase as these values increase.

Ripple voltage	CBS50/100/200/35024: less than 2Vp-p CBS50/100/200/35048: less than 4Vp-p CBS45048: less than 4Vp-p
----------------	---

■ Make sure that the peak input voltage stays within the specified input voltage range of the power module.

■ Choose a front end power supply that can supply enough current I_p (Fig. 2.2) for starting up the power module.

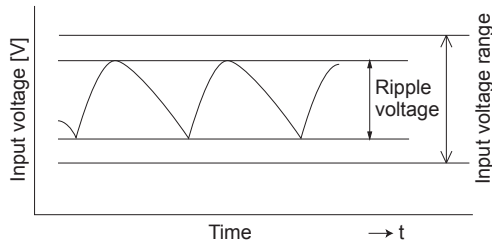

Fig.2.1 Input Voltage Ripple

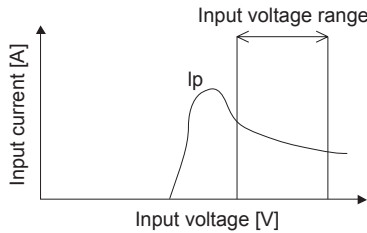

Fig.2.2 Input Current Characteristics

(5) Reverse Input Voltage Protection

■ Avoid applying reversed-polarity voltage to the power module as it will damage the power module. To protect the power module from reversed polarity voltage, installing an external diode as shown in Fig. 2.3 is recommended.

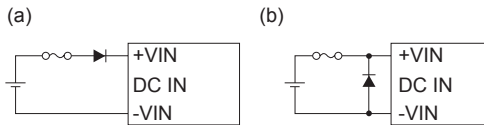

Fig.2.3 Reverse Input Voltage Protection

2.2 Wiring output pin

■ Install an external capacitor C_o between +VOUT and -VOUT to increase stability of output (Fig. 1.1).

Recommended capacitance of C_o is shown in Table 2.2.

■ Choose a high frequency type electrolytic capacitor for C_o . Output ripple and rise time will be influenced by the capacitor's ESR and ESL and the wiring impedance.

■ As ripple current will flow through capacitor C_o , pay attention to the ripple current rating of the capacitor.

■ Install capacitor C_o as close to the power module as possible (within 50mm).

This is useful for reducing radiated noise and increasing stability of the power module operation.

 Table 2.2 Recommended Capacitance for External Output Capacitor C_o (μF)

Base plate temperature : $T_c = -20$ to $+100^\circ\text{C}$							
VOUT	1.8V/2.5V/3.3V/5V	12V	15V	24V	28V	32V	48V
CBS50	2200	470		220		—	—
CBS100	2200	470		220		—	—
CBS200	2200	1000		470		—	330
CBS350	—	470	—	220			
CBS450	—	—		220			—
Base plate temperature : $T_c = -40$ to $+100^\circ\text{C}$							
VOUT	1.8V/2.5V/3.3V/5V	12V	15V	24V	28V	32V	48V
CBS50	2200×2	470×2		220×2		—	—
CBS100	2200×2	470×2		220×2		—	—
CBS200	2200×2	1000×2		470×2		—	330×3
CBS350	—	470×3	—	220×3			
CBS450	—	—		220×3			—

■ The specified ripple and ripple noise are measured by the method introduced in Fig. 2.4.

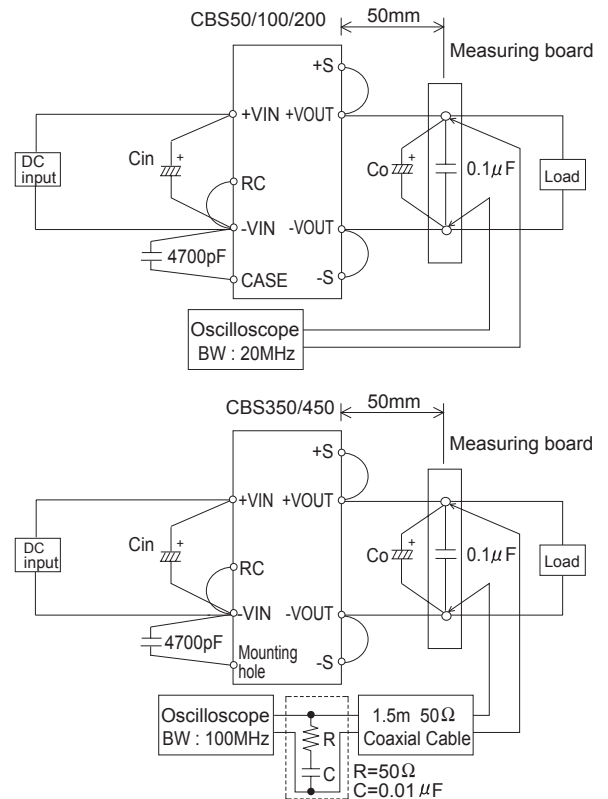

Fig.2.4 Method of Measuring Output Ripple and Ripple Noise

3 Function

3.1 Overcurrent protection

Over Current Protection (OCP) is built in and works over 105% of the rated current or higher. However, use in an over current situation must be avoided whenever possible. The output voltage of the power module will recover automatically if the fault causing over current is corrected.

When the output voltage drops after OCP works, the power module enters a "hiccup mode" where it repeatedly turns on and off at a certain frequency.

3.2 Overvoltage protection

Over Voltage Protection (OVP) is built in. When OVP works, output voltage can be recovered by shutting down DC input for at least one second or by turning off the remote control switch for one second without shutting down the DC input. The recovery time varies according to input voltage and input capacitance.

Remarks:

Note that devices inside the power module may fail when a voltage greater than the rated output voltage is applied from an external power supply to the output terminal of the power module. This could happen in in-coming inspections that include OVP function test or when voltage is applied from the load circuit. OVP can be tested by using the TRM terminal. Consult us for details.

3.3 Thermal protection

Over Temperature Protection (OTP) is built in. If the base plate temperature exceeds 100°C, OTP will work, causing the output voltage to drop. Output voltage can be recovered by shutting down DC input for at least one second or by turning RC off for one second without shutting down the DC input.

3.4 Remote ON/OFF

The remote ON/OFF function is incorporated in the input circuit and operated with RC and -VIN. If positive logic control is required, order the power module with "-R" option.

Table 3.1 Remote ON/OFF Specifications

	ON/OFF logic	Between RC and -VIN	Output voltage
Standard	Negative	L level(0 - 1.2V) or short	ON
		H level(3.5 - 7.0V) or open	OFF
Optional -R	Positive	L level(0 - 1.2V) or short	OFF
		H level(3.5 - 7.0V) or open	ON

When RC is at low level, a current of 0.5mA typ will flow out. When Vcc is used, keep it within the following rage:

$$3.5 \leq V_{CC} \leq 7V.$$

When remote ON/OFF is not used, short RC and -VIN.

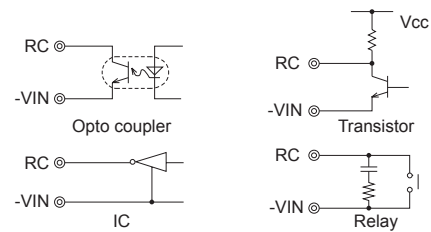

Fig.3.1 RC Connection Example

3.5 Remote sensing

(1) When Remote Sensing is Not Used

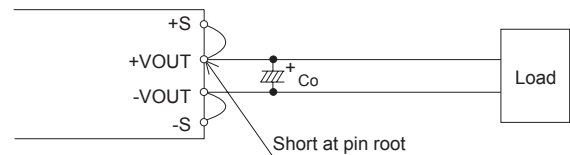

Fig.3.2 When Remote Sensing is Not Used

When remote sensing is not used, make sure +VOUT and +S are shorted, and that -VOUT and -S are shorted as well.

Keep the patterns between +S and +VOUT and between -S and -VOUT as short as possible. Avoid a looping pattern. If noise enters the loop, the operation of the power module will become unstable.

(2) When Remote Sensing is Used

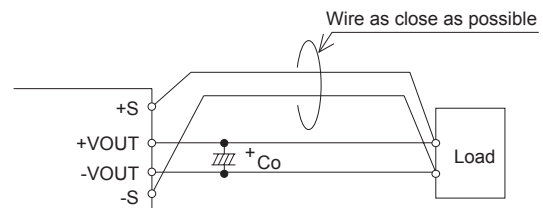

Fig.3.3 When Remote Sensing is Used

Using remote sensing with long wires may cause output voltage to become unstable. Consult us if long sensing wiring is necessary.

Sensing patterns or wires should be as short as possible. If wires are used, use either twisted-pair or shielded wires.

Use wide PCB patterns or thick wires between the power module and the load. Line drop should be kept less than 0.3V. Make sure output voltage from the power module stays within the specified range.

If the sensing patterns are shorted by mistake, a large current may flow and damage the pattern. This can be prevented by installing fuses or resistors close to the load.

As wiring or load impedance may generate oscillation or large fluctuations in output voltage, make sure enough evaluation is given in advance.

3.6 Adjustable voltage range

Output voltage can be adjusted by connecting an external potentiometer (VR1) and resistors (R1 and R2) as shown in Fig. 3.5. Output voltage will increase if the resistance between ① and ② is reduced by turning the potentiometer clockwise. Recommended values for external components are shown in Table 3.2.

Consult us if the power module is used in a different configuration. Output voltage between +VOUT and -VOUT can be adjusted by connecting external resistors to TRM.

However, when the input voltage is 18 - 20VDC with CBS50/100/20024 or 36 - 40VDC with CBS50/100/20048, the output voltage adjustment range is 60 - 105% of the rated output voltage except for 1.8/2.5/48V output models. When input voltage is 20 - 22VDC with CBS35024 models or 36 - 40VDC with CBS35048 models, the output voltage adjustment range becomes as shown in Fig. 3.4-1.

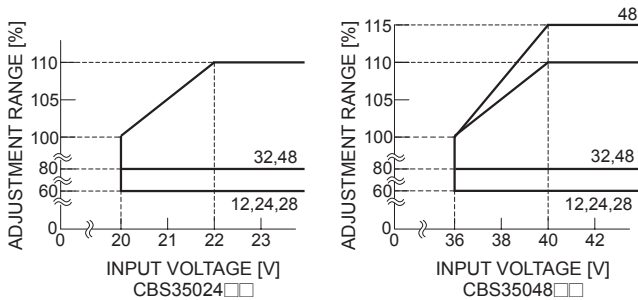

Fig.3.4-1 CBS350 Output Voltage Adjustment Range

The output adjustment range for CBS450 is shown in Fig. 3.4-2.

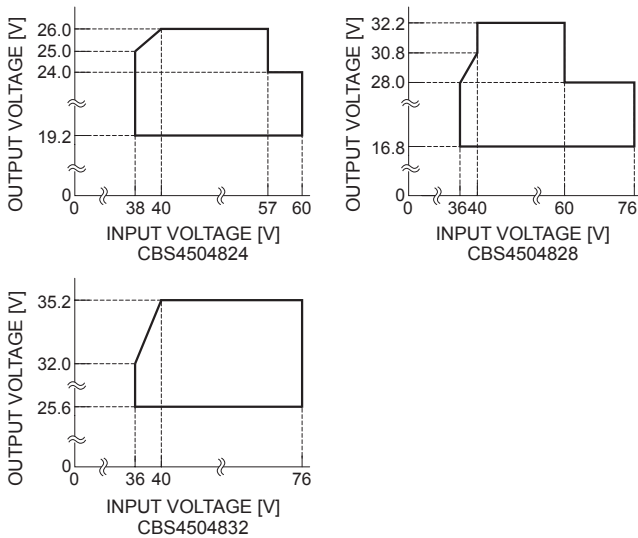

Fig.3.4-2 CBS450 Output Voltage Adjustment Range

The wiring to the potentiometer should be as short as possible. As the ambient temperature fluctuation characteristics deteriorates depending on the types of resistors and potentiometers used, please use resistors and potentiometers of the following specifications:

- Resistors..... Metal film type, coefficient less than $\pm 100\text{ppm}/^\circ\text{C}$
- Potentiometers ... Cermet type, coefficient less than $\pm 300\text{ppm}/^\circ\text{C}$

When output voltage adjustment is not required, open TRM. Note that, when adjusting output voltage, setting output voltage too high may cause OVP to work.

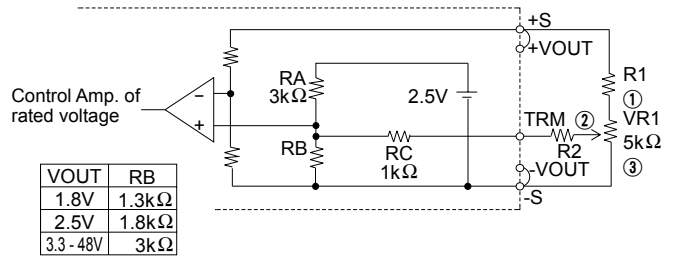

Fig.3.5 Connecting External Parts

Table 3.2 Recommended Values of External Resistors

No.	VOUT	Adjustable range			
		VOUT $\pm 5\%$		VOUT $\pm 10\%$	
		R1	R2	R1	R2
1	1.8V	1.8kΩ	6.2kΩ	1.6kΩ	3.6kΩ
2	2.5V	2.7kΩ	7.5kΩ	2.4kΩ	4.7kΩ
3	3.3V	2.4kΩ	11kΩ	2.4kΩ	6.8kΩ
4	5V	5.6kΩ		5.6kΩ	
5	12V	18kΩ		18kΩ	
6	15V	24kΩ		24kΩ	
7	24V	43kΩ		39kΩ	
8	28V	51kΩ		47kΩ	
9	32V	56kΩ		56kΩ	
10	48V	82kΩ		82kΩ	

3.7 Withstanding Voltage / Isolation Voltage

When testing the withstanding voltage, make sure the voltage is increased gradually. When turning off, reduce the voltage gradually by using the dial of the hi-pot tester. Do not use a voltage tester with a timer as it may generate voltage several times as large as the applied voltage.

4 Series and Parallel Operation

4.1 Series operation

Multiple CBS units can be used in series. Keep the output current less than the smallest specified rated current of the modules connected in series. Make sure the current flow into the power module will not exceed the rated current.

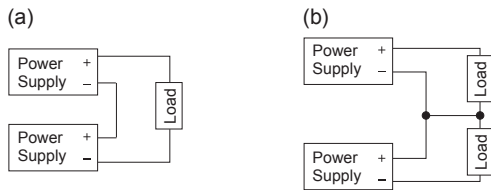

Fig.4.1 Examples of Series Operation

4.2 Redundancy operation

Parallel operation is not possible.

Redundancy operation is available by wiring as shown below.

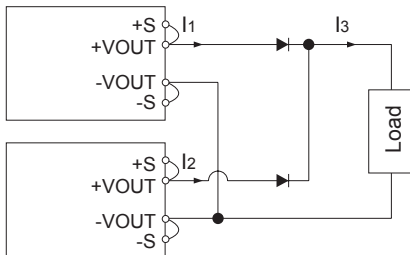

Fig.4.2 Example of Redundancy Operation

Even a slight difference in output voltage can affect the balance between the values of I_1 and I_2 .

Please make sure that the value of I_3 does not exceed the rated current of a power supply.

$$I_3 \leq \text{the rated current value}$$

5 Cleaning

Clean the soldered side of the power module with a brush.

Prevent liquid from getting into the power module. Do not clean by soaking the power module into liquid.

Do not allow solvent to come in contact with product labels or resin cases as this may change the color of the resin case or cause deletion of the letters printed on the product label.

After cleaning, dry the power modules well.

6 Safety Considerations

To apply for safety standard approvals with the power module, the following conditions must be met. Consult us for more details.

- The power modules must be used as a component power supply in end-use equipment.
- Neither basic isolation nor double/reinforced isolation is provided across input, output and the base plate of the power module. If the power module is to be used with input voltage of more than 60VDC and needs basic or double/reinforced isolation, the required isolation must be provided in the construction of the final product.
- Use external fuses that comply with safety standards at the input.

7 Options

7.1 Addition of a Heat sink(Optional:F□)

Heat sink pre-attached models are also available.

(Except CBS350/450)

Table 7.1 Types of Heat Sink Pre-Attached Models Available

Option	Size[mm]			Weight [g]	Style	Heat sink type name
	H	W	D			
F1	26.5	58.7	62.5	150 or less	Horizontal	F-CBS-F1
F2	26.5	59.5	62.0		Vertical	F-CBS-F2
F3	39.2	58.7	62.5	170 or less	Horizontal	F-CBS-F3
F4	39.2	59.5	62.0		Vertical	F-CBS-F4
F5	52.0	58.7	62.5	185 or less	Horizontal	F-CBS-F5
F6	52.0	59.5	62.0		Vertical	F-CBS-F6

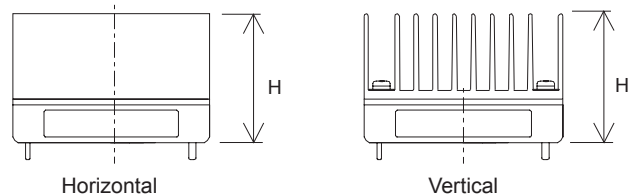
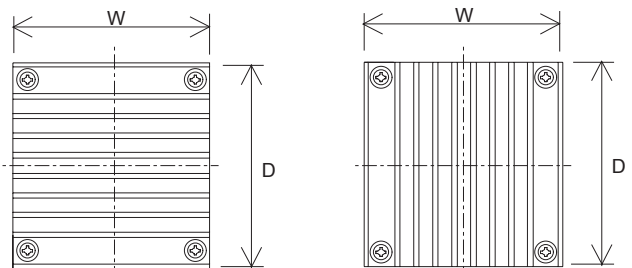

Fig.7.1 Dimensions of Heat Sink Pre-Attached Models

Derating curve characteristics with respect to aluminum base plate temperature are shown in Fig. 7.2. Measure the temperature of the base plate in a location away from direct airflow (A). Note that operation within the hatched areas will cause a significant level of ripple and ripple noise.

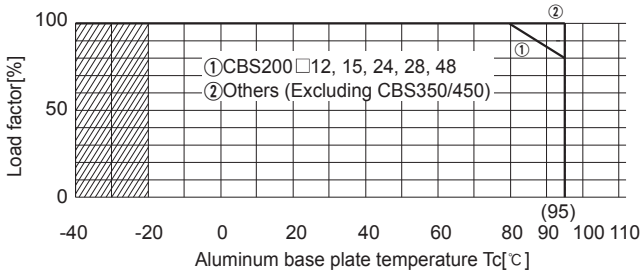

Fig.7.2 Derating Curve Characteristics

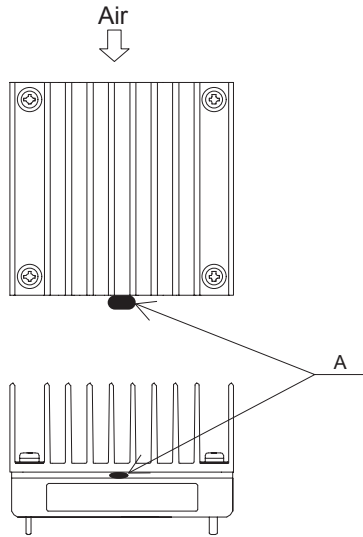

Fig.7.3 Measuring Point

Make sure that PCB mounting screws do not touch the heat sink mounting screws.

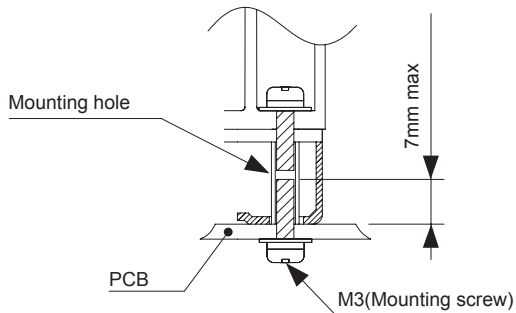

Fig.7.4 PCB Mounting Screw Dimensions