



High-Voltage, Non-Isolated Buck-Boost Converter for ISDN Digital Phones

FEATURES

- Fixed +5-V or +3.3-V Output
- Integrated Floating Feedback Amplifier
- On-Chip 70-V, 1.5- Ω N-Channel MOSFET Switch
- Integrated High Voltage Start-Up Circuit, with V_{CC} Regulator
- -10-V to -60-V Input Voltage Range
- 95-kHz PWM Operation
- Integrated Soft-Start and Oscillator
- High Efficiency Over Full Load Range
- Under Voltage Lockout
- Current Mode Control
- Hiccup Mode Short Circuit Protection
- Thermal Shutdown
- SOIC-8 Narrow-Body Package

DESCRIPTION

The Si9121 simplifies the -48-V to +5-V or +3.3-V converter design for ISDN application by integrating the floating feedback error amplifier providing direct output voltage regulation. This approach eliminates the need for an external shunt regulator. The Si9121 also integrates a high voltage depletion mode MOSFET which allows the converter to be powered directly from the high input bus voltage without requiring an external start-up circuit. Combined with simple magnetic design due to its non-isolated topology, the Si9121 provides a one-chip solution for complete ISDN power supply.

In order to reduce external component count, the Si9121 has a fully integrated 95-kHz oscillator and soft-start circuit.

The Si9121 is available in both standard and lead (Pb)-free SOIC-8 pin packages, and is offered in either +5-V or +3.3-V fixed output options (Si9121DY-5 or Si9121DY-3, respectively). In order to satisfy the stringent ambient temperature requirements in many applications, the Si9121 is rated to the industrial temperature range of -40°C to 85°C.

FUNCTIONAL BLOCK DIAGRAM

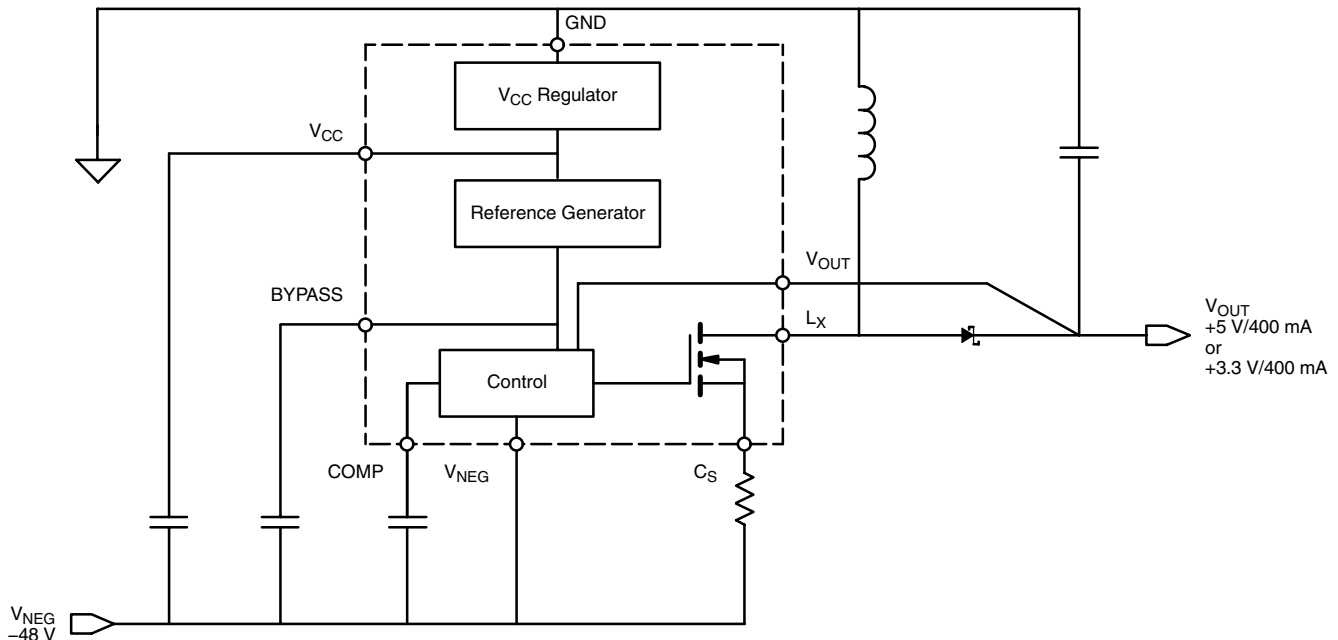

ABSOLUTE MAXIMUM RATINGS (ALL VOLTAGES REFERENCED TO GND = 0 V)

V_{NEG}	-63 V	Operating Junction Temperature	150°C
V_{CS}	$V_{NEG} - 0.3$ V to $V_{CC} + 0.3$ V	Power Dissipation (Package) ^a	
V_{CC}	$V_{NEG} + 13.2$ V	8-Pin SOIC (Y Suffix) ^b	1.25 W
I_{LX} (peak current)	3 A	Thermal Impedance (Θ_{JA}) ^a	
V_{OUT}	6 V	8-Pin SOIC	100 °C/W
Bypass, CS	$V_{NEG} - 0.3$ V to $V_{CC} + 0.3$ V	Notes	
($V_{LX} - V_{CS}$) internal power MOSFET	70 V	a. Device mounted with all leads soldered or welded to PC board.	
Storage Temperature	-65 to 150°C	b. Derate 10 mW/°C above 25°C.	

Stresses beyond those listed under "Absolute Maximum Ratings" may cause permanent damage to the device. These are stress ratings only, and functional operation of the device at these or any other conditions beyond those indicated in the operational sections of the specifications is not implied. Exposure to absolute maximum rating conditions for extended periods may affect device reliability.

RECOMMENDED OPERATING RANGE (ALL VOLTAGES REFERENCED TO GND = 0 V)

V_{NEG}	-10 V to -60 V	V_{CC} (externally supplied)	$V_{NEG} + 9.5$ V to $V_{NEG} + 12.0$ V
V_{CC} (internally regulated)	$V_{NEG} + 8.5$ V	Digital Inputs	0 V to V_{CC}

RECOMMENDED EXTERNAL COMPONENTS (SEE TYPICAL APPLICATIONS CIRCUIT)

$L = 68 \mu\text{H}$, $C_{OUT} = 220 \mu\text{F} // 0.1 \mu\text{F}$, $C_{IN} = 33 \mu\text{F}$, $C_{BYPASS} = 0.1 \mu\text{F}$, $C_{VCC} = 1 \mu\text{F}$, $R_{SENSE} = 0.25 \Omega$, 0.5 W

SPECIFICATIONS ^a (All Voltages Are With Respect To V_{NEG} Unless Otherwise Specified)							
Parameter	Symbol	Test Conditions (Internally Regulated) Unless Otherwise Specified $V_{NEG} = -10$ to -60 V	Temp ^b	Limits -40 to 85°C			Unit
				Min ^c	Typ ^d	Max ^c	
Output Voltage (with respect to GND = 0 V)							
+5-V Converter	V_{OUT}	10 mA $<I_{LOAD} < 250$ mA	Full	4.80	5.00	5.20	V
+3.3-V Converter			Full	3.17	3.30	3.43	
Line Regulation (with respect to GND = 0 V)							
Line Regulation		$-60 \text{ V} \leq V_{NEG} \leq -40 \text{ V}$	Full			1	%
V_{CC} (Internal Regulator)							
V_{CC} Bias Voltage	V_{CC}		Full	7.5	8.5	9.5	V
UVLO							
Under Voltage Lockout	$V_{CC} - V_{NEG}$	Turn-On	Full	6.6	7.6	8.7	V
Hysteresis	ΔV		Room		0.6		
Soft-Start							
Error Amplifier Start-Up Current	I_{SS}	$V_{OUT} = 0$ V	Room		10		μA
Oscillator							
Switching Frequency	f_{OSC}		Room	80	95	110	kHz
Error Amplifier							
Transconductance	gm		Room	10	15	20	umho
Clamp Voltage	V_{CL}	Internal Error Amplifier Output Clamp Voltage	Room		3.5		V
Current Limit							
Threshold Voltage	V_{CS}		Full	0.57	0.67	0.77	V
MOSFET Switch							
N-Channel MOSFET	$r_{DS(on)}$		Room		1.5	2.5	Ω

SPECIFICATIONS^a (All Voltages Are With Respect To V_{NEG} Unless Otherwise Specified)							
Parameter	Symbol	Test Conditions (Internally Regulated) Unless Otherwise Specified $V_{NEG} = -10$ to -60 V	Temp ^b	Limits -40 to 85°C			Unit
				Min ^c	Typ ^d	Max ^c	
Supply							
Supply Current (Internally Regulator)	I_{GND}	GND to V_{NEG}	Full		1.2	1.5	mA
Supply Current (External V_{CC} Applied)	I_{CC}	V_{CC} to $V_{NEG} + 10$ V; $V_{NEG} > -20$ V	Full		1.5	2.0	
V_{OUT} supply Current	I_{OUT}	V_{OUT} to V_{NEG}	Full		0.2	0.3	
Start-Up Current	I_{START}	$V_{CC} = 0$ V	Full		5	30	
Thermal Shutdown							
Thermal Shutdown Temperature	T_{OTP}				170		°C
Thermal Hysteresis	T_{HYS}				25		
Efficiency							
Efficiency		400-mA Output, $V_{NEG} = -48$ V	+5 V	Room		77	%
			+3.3 V	Room		73	

Notes

- Refer to PROCESS OPTION FLOWCHART for additional information.
- Room = 25°C, Full = as determined by the operating temperature suffix.
- The algebraic convention whereby the most negative value is a minimum and the most positive a maximum.
- Typical values are for DESIGN AID ONLY, not guaranteed nor subject to production testing.

DETAILED BLOCK DIAGRAM

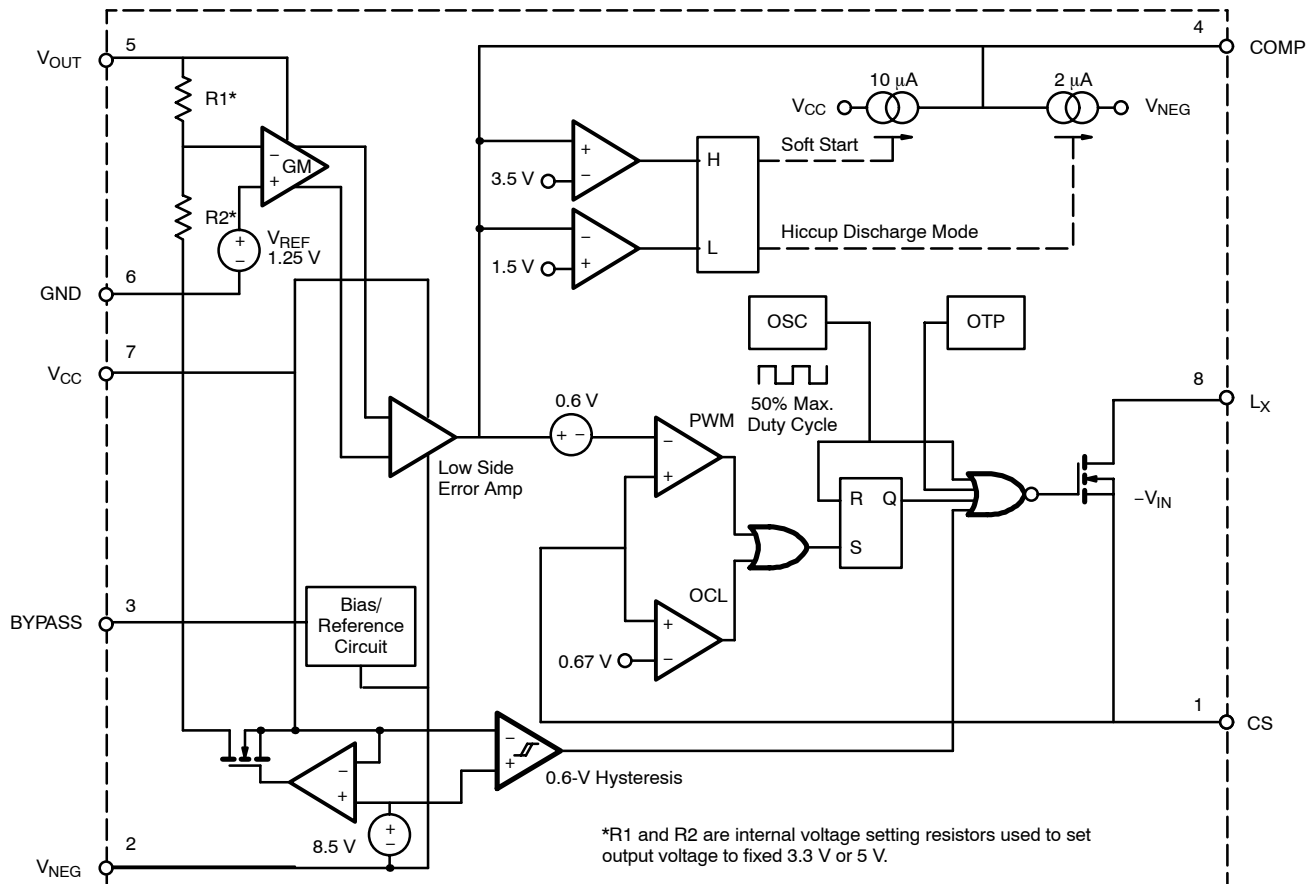

TYPICAL CHARACTERISTICS (INTERNALLY REGULATED, 25°C UNLESS NOTED)

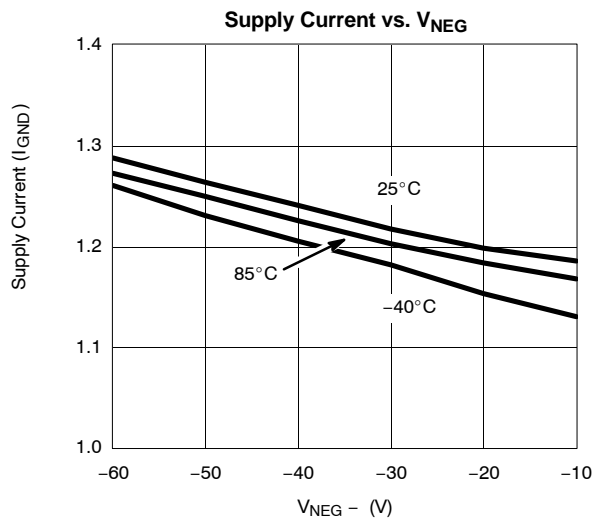
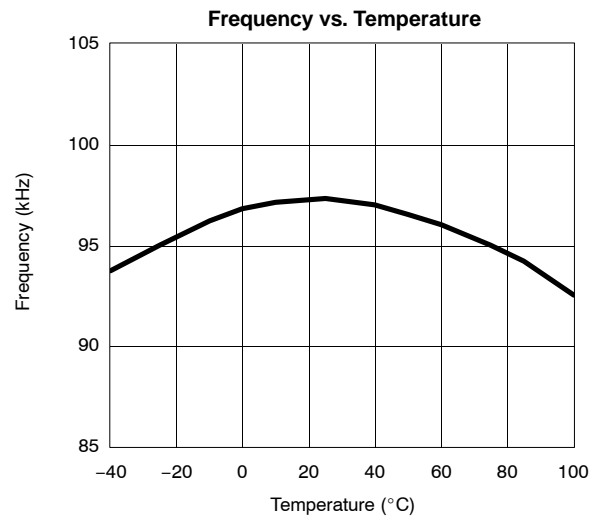
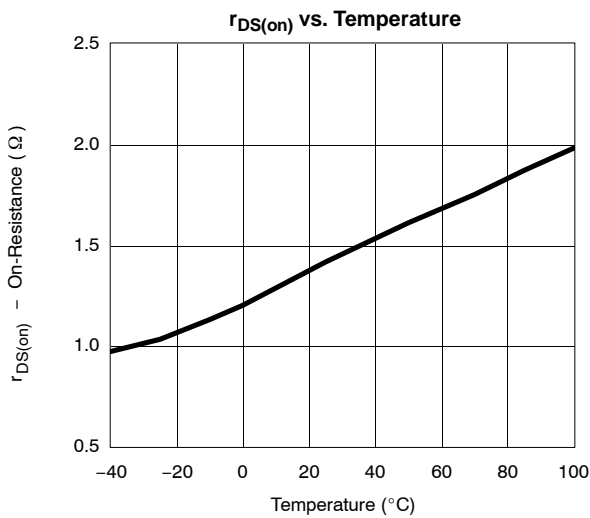
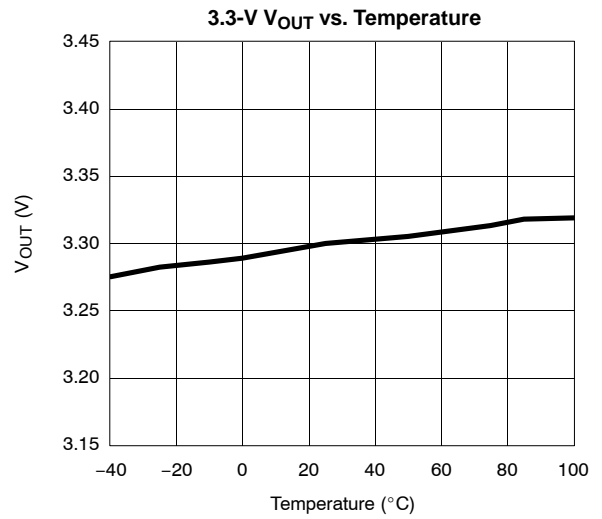
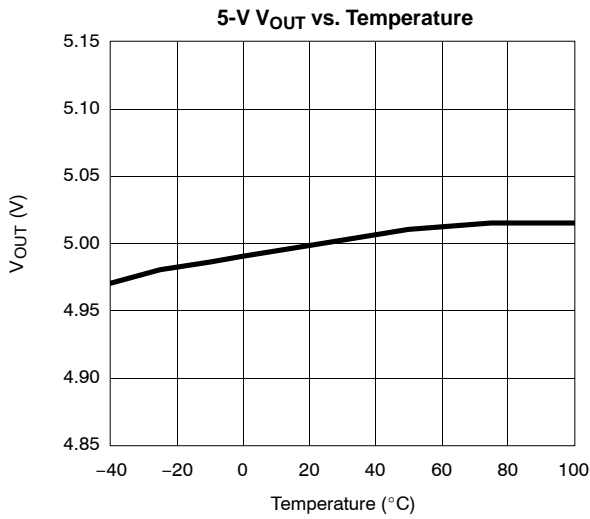

TYPICAL CHARACTERISTICS (INTERNALLY REGULATED, 25°C UNLESS NOTED)

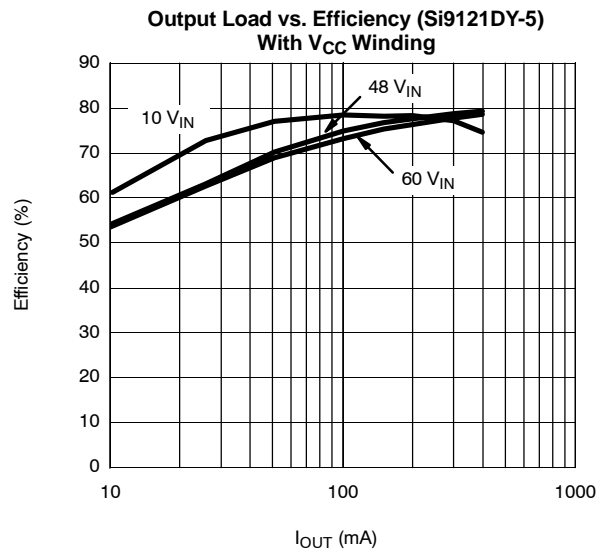
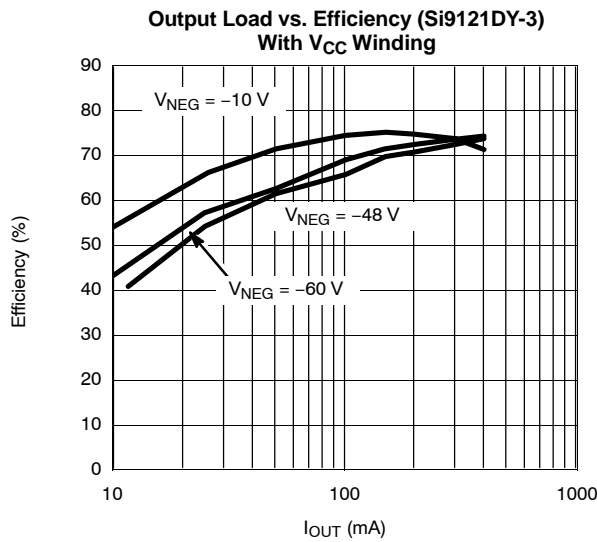
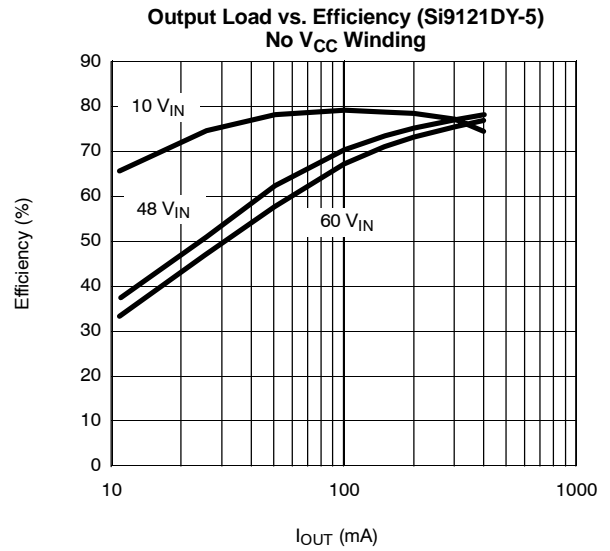
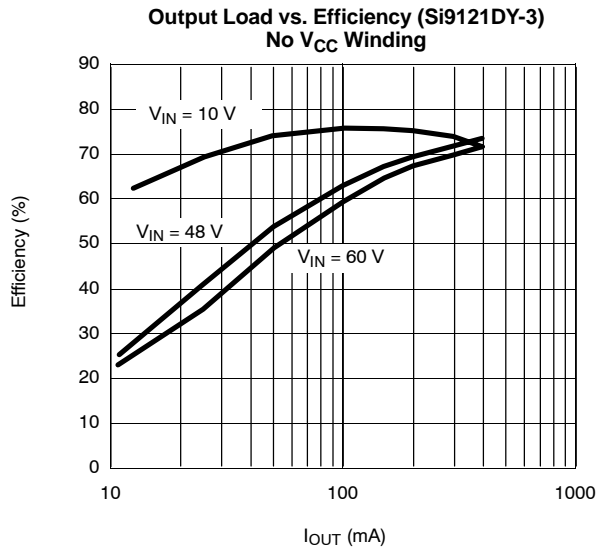

PIN CONFIGURATION AND ORDERING INFORMATION

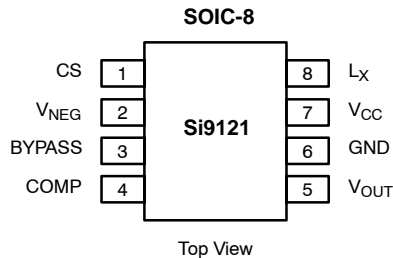

ORDERING INFORMATION

Part Number	Temperature Range	Package
Si9121DY-5-T1	-40 to 85°C	Tape and Reel
Si9121DY-5-T1—E3		
Si9121DY-3-T1		
Si9121DY-3-T1—E3		
Si9121DY-5	-10 to 70°C	Bulk
Si9121DY-3		

Eval Kit	Temperature Range	Board Type
Si9121DB-5	-10 to 70°C	Surface Mount and Thru-Hole
Si9121DB-3		

PIN DESCRIPTION

Pin Number	Name	Function
1	CS	Current sense pin to detect the inductor current for current mode control and over current protection
2	V _{NEG}	Negative supply voltage (-10 V to -60 V)
3	BYPASS	+1.5-V bandgap reference. Decouple with 0.1 μF capacitor.
4	COMP	Compensation node to stabilize the converter
5	V _{OUT}	Output voltage feedback connected to the PWM summing comparator
6	GND	Low impedance system ground
7	V _{CC}	Internally generated supply voltage for the internal circuit and MOSFET drive circuit. Decouple with an external bypass capacitor.
8	L _X	Inductor connection node

DETAILED DESCRIPTION

Start-Up

The UVLO circuit prevents the internal circuits from turning on if V_{CC} is less than 7.6 V (typical) above the negative supply voltage at V_{NEG} pin. With a typical hysteresis of 0.6 V, the controller is continuously powered on until the V_{CC} voltage drops below 7.0 V. This hysteresis prevents the converter from oscillating during the start-up phase and unintentionally locking up the system. Once (V_{CC} - V_{NEG}) exceeds the UVLO threshold the internal reference, oscillator, and soft-start circuits are enabled.

Soft-Start

The Si9121 has an on-chip soft-start circuit which utilizes the error amplifier external compensation network to ramp the output NMOS transistor current limit which, in turn, allows the output voltage to rise gradually without excessive overshoot. The soft-start circuit is enable once the V_{CC} voltage exceeds

the UVLO threshold. For the recommended frequency compensation components (see Typical Application Circuit) the soft-start time is approximately 10 ms.

Oscillator

The oscillator is designed to operate at a nominal frequency of 95 kHz with no external components. The 95-kHz operating frequency allows the converter to operate in PWM mode during the full load condition even though the duty cycle is very low. The 95kHz switching frequency also allows the converter to operate at optimal efficiency without a large output inductor and capacitor.

PWM Mode and Current Limit

The Si9121 is a current-mode converter designed to operate in PWM mode. It features pulse-by-pulse peak current limiting such that when the peak current sensed voltage on the CS pin is greater than 0.67 V the switch is turned off for the remainder of the clock cycle.



DETAILED DESCRIPTION

Bypass

The bypass voltage of the Si9121 is set at a particular positive reference relative to the V_{NEG} pin. The bypass voltage is used to set an accurate voltage and bias current for the on-chip oscillator and soft-start circuits. The 0.1- μ F ceramic decoupling capacitor is recommended between the bypass and V_{NEG} . No other components should be connected to this pin.

Error Amplifier

With a -48-V bus voltage, the converter is referenced to the -48-V (V_{NEG}) node as its system ground. However, the +5-V or +3.3-V output is referenced to the GND pin, which is normally connected to 0 V. To regulate this output voltage, the Si9121 has an on-chip error amplifier which continuously monitors the output voltage and compares it to a reference voltage. This difference signal is level-shifted to the low side circuit to control the power switch duty-cycle and hence the regulation of the output voltage. Frequency compensation for the error amplifier is achieved by connecting an external network between the COMP pin and the V_{NEG} pin.

V_{CC} Regulator

V_{CC} is an internally generated bias supply voltage which should be externally bypassed with a 0.1- μ F capacitor connected to the negative supply voltage, V_{NEG} . No load current should be drawn from the V_{CC} pin. V_{CC} may be supplied from an external source of 9.5-V to 12-V referenced to V_{NEG} . In this configuration, the internal V_{CC} regulator is disabled when the V_{CC} receives 9.5-V, or greater, above V_{NEG} .

Thermal Shutdown

The Si9121 also includes thermal shutdown which shuts down the device when junction temperature exceeds 170°C due to over heating. In thermal shutdown once the die temperature cools to below 145°C the regulator is enabled. If the die temperature is excessive due to high package power

dissipation the regulator's thermal circuit will continue to pulse the regulator on and off. This is called thermal cycling.

Hiccup Mode Short Circuit Protection

In addition to the thermal shutdown and the cycle-by-cycle current limiting features already described, the Si9121 has a built-in hiccup mode timer to handle a continuous output short-circuit and to automatically restart the device when the short-circuit is removed.

If an output short-circuit occurs, the device immediately enters a cycle-by-cycle current limiting mode. As long as the thermal shutdown is not activated then the Si9121 automatically determines whether the internal hiccup timer should be started by monitoring the COMP pin. If V_{COMP} exceeds an upper threshold voltage (approximately 3.5 V) the timer is started and the external network at the COMP pin is discharged by an internal 2- μ A current sink until V_{COMP} reaches approximately 1.5 V. (Note: all voltages are with respect to V_{NEG}). At this point, the circuit reverts to the normal soft-start mode, whereby the COMP network is charged by its internal soft-start 10- μ A current source and the circuit will attempt to start up in the normal manner. However, if the output short circuit is still present, the converter will again enter the cycle-by-cycle current limiting mode until the COMP pin voltage reaches 3.5 V, whereupon this cycle repeats until the short circuit is removed.

The duty cycle imposed by the hiccup timer allows the Si9121 to handle continuous short-circuit without damage as long as the recommended component values shown in the Typical Application Circuit are used.

MOSFET Switch

The low-side n-channel MOSFET switch is integrated to provide optimum performance and to minimize the overall converter size. The typical 1.5- Ω $r_{DS(on)}$ of the MOSFET allows the converter to deliver up to 2 W of output power.

TYPICAL APPLICATION CIRCUIT

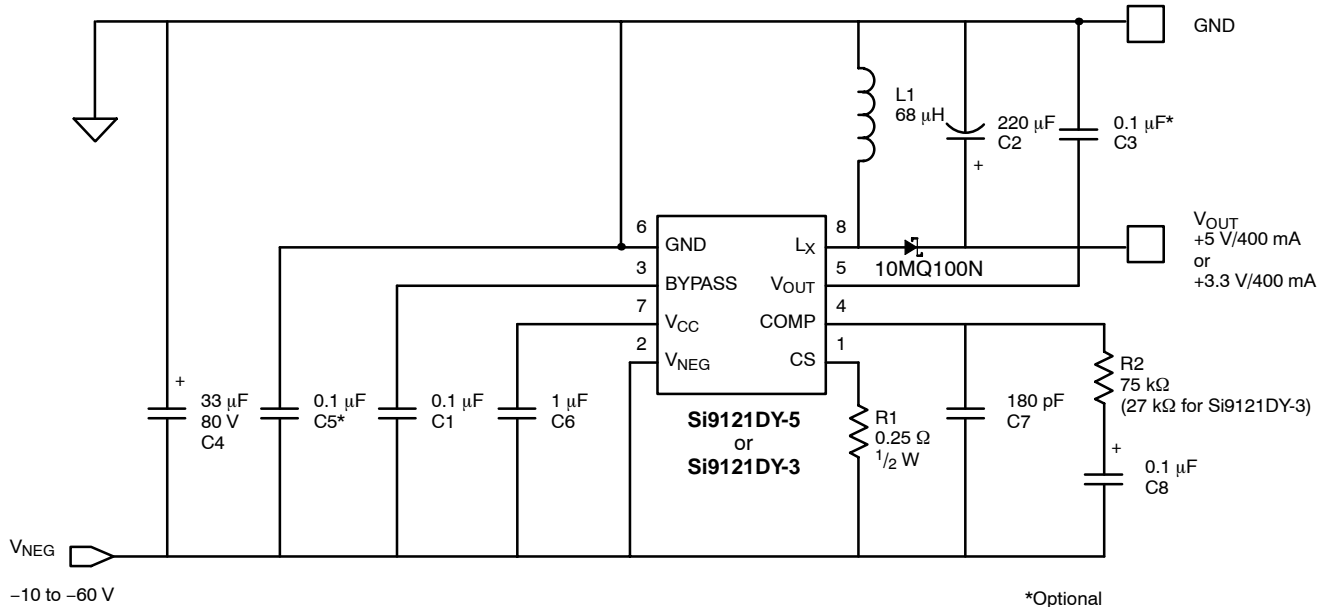

Silk Screen

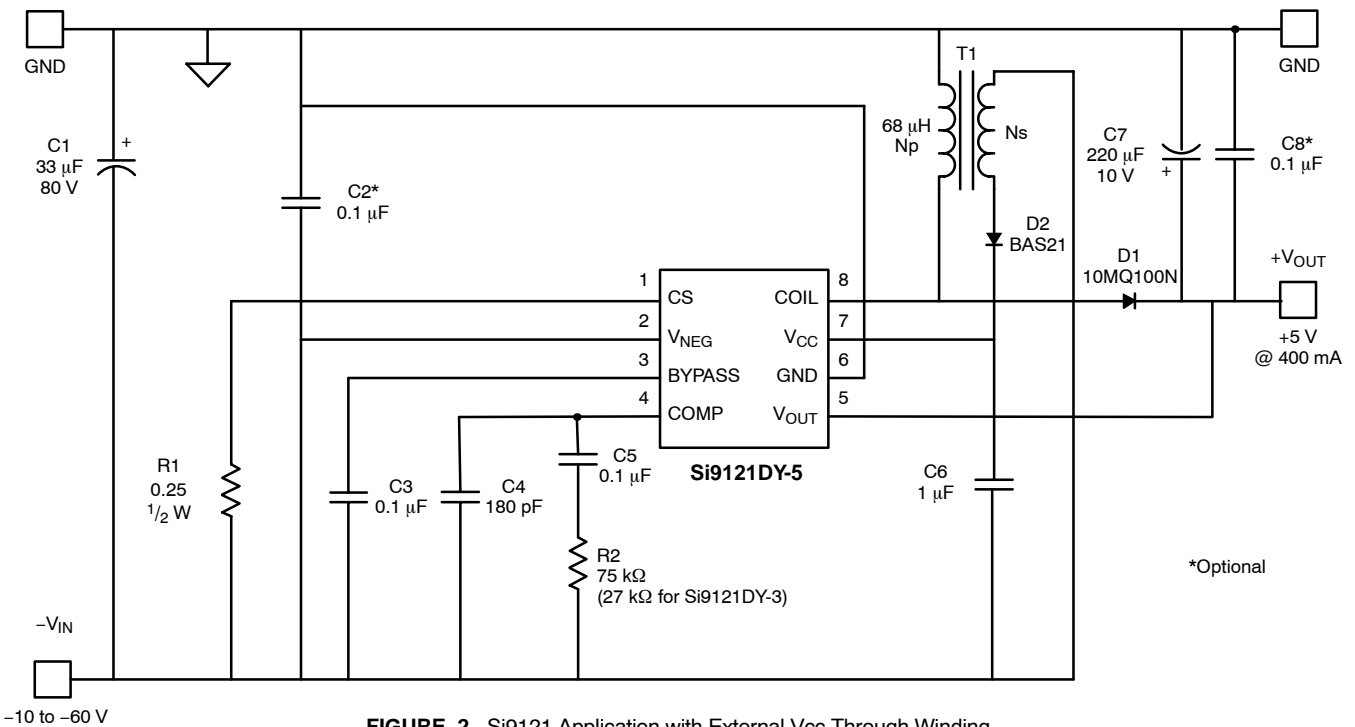

SOIC (NARROW): 8-LEAD

JEDEC Part Number: MS-012



DIM	MILLIMETERS		INCHES	
	Min	Max	Min	Max
A	1.35	1.75	0.053	0.069
A ₁	0.10	0.20	0.004	0.008
B	0.35	0.51	0.014	0.020
C	0.19	0.25	0.0075	0.010
D	4.80	5.00	0.189	0.196
E	3.80	4.00	0.150	0.157
e	1.27 BSC		0.050 BSC	
H	5.80	6.20	0.228	0.244
h	0.25	0.50	0.010	0.020
L	0.50	0.93	0.020	0.037
q	0°	8°	0°	8°
S	0.44	0.64	0.018	0.026
ECN: C-06527-Rev. I, 11-Sep-06				
DWG: 5498				



Disclaimer

ALL PRODUCT, PRODUCT SPECIFICATIONS AND DATA ARE SUBJECT TO CHANGE WITHOUT NOTICE TO IMPROVE RELIABILITY, FUNCTION OR DESIGN OR OTHERWISE.

Vishay Intertechnology, Inc., its affiliates, agents, and employees, and all persons acting on its or their behalf (collectively, "Vishay"), disclaim any and all liability for any errors, inaccuracies or incompleteness contained in any datasheet or in any other disclosure relating to any product.

Vishay makes no warranty, representation or guarantee regarding the suitability of the products for any particular purpose or the continuing production of any product. To the maximum extent permitted by applicable law, Vishay disclaims (i) any and all liability arising out of the application or use of any product, (ii) any and all liability, including without limitation special, consequential or incidental damages, and (iii) any and all implied warranties, including warranties of fitness for particular purpose, non-infringement and merchantability.

Statements regarding the suitability of products for certain types of applications are based on Vishay's knowledge of typical requirements that are often placed on Vishay products in generic applications. Such statements are not binding statements about the suitability of products for a particular application. It is the customer's responsibility to validate that a particular product with the properties described in the product specification is suitable for use in a particular application. Parameters provided in datasheets and / or specifications may vary in different applications and performance may vary over time. All operating parameters, including typical parameters, must be validated for each customer application by the customer's technical experts. Product specifications do not expand or otherwise modify Vishay's terms and conditions of purchase, including but not limited to the warranty expressed therein.

Hyperlinks included in this datasheet may direct users to third-party websites. These links are provided as a convenience and for informational purposes only. Inclusion of these hyperlinks does not constitute an endorsement or an approval by Vishay of any of the products, services or opinions of the corporation, organization or individual associated with the third-party website. Vishay disclaims any and all liability and bears no responsibility for the accuracy, legality or content of the third-party website or for that of subsequent links.

Except as expressly indicated in writing, Vishay products are not designed for use in medical, life-saving, or life-sustaining applications or for any other application in which the failure of the Vishay product could result in personal injury or death. Customers using or selling Vishay products not expressly indicated for use in such applications do so at their own risk. Please contact authorized Vishay personnel to obtain written terms and conditions regarding products designed for such applications.

No license, express or implied, by estoppel or otherwise, to any intellectual property rights is granted by this document or by any conduct of Vishay. Product names and markings noted herein may be trademarks of their respective owners.