

Smart LED Lamp Driver IC with PFC Function

FL7701

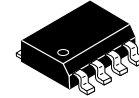

SOIC8
CASE 751EB

Description

The FL7701 LED lamp driver is a simple IC with PFC function. The special “adopted digital” technique of the IC can automatically detect input voltage condition and send an internal reference signal for achieving high power factor. When AC input is applied to the IC, PFC function is automatically enabled. Otherwise, when DC input is applied to the IC, PFC function is automatically disabled. The FL7701 does not need a bulk capacitor (electrolytic capacitor) for supply rail stability, which can significantly affect to LED lamp system.

Features

- Digitally Implemented Active PFC Function (No Additional Circuit Necessary for High PF)
- Built-in HV Supplying Circuit: Self Biasing
- Application Input Range: 80 V_{AC}~308 V_{AC}
- AOCF Function with Auto-Restart Mode
- Built-in Over-Temperature Protection Function
- Cycle-by-Cycle Current Limit
- Current-Sense Pin Open Protection
- Low Operating Current: 0.85 mA (Typical)
- Under-Voltage Lockout with 5 V Hysteresis
- Programmable Oscillation Frequency
- Programmable LED Current
- Analog Dimming Function
- Soft-Start Function
- Precise Internal Reference: ±3%

Applications

- LED Lamp for Decorative Lighting
- LED Lamp for Low-Power Lighting

Related Resources

- [Evaluation Board: FEBFL7701_L30U003A](#)

MARKING DIAGRAM

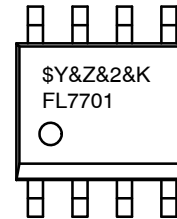

- FL7701 = Device Code
- \$Y = onsemi Logo
- &Z = Assembly Plant Code
- &2 = 2-Digit Date Code Format
- &K = 2-Digits Lot Run Traceability Code

ORDERING INFORMATION

See detailed ordering and shipping information on page 10 of this data sheet.

FL7701

PIN CONFIGURATION

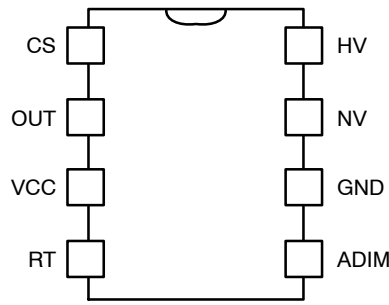

Figure 3. Pin Configuration

PIN DEFINITIONS

Pin No.	Name	Description
1	CS	<i>Current Sense.</i> Limits output current depending on the sensing resistor voltage. The CS pin is also used to set the LED current regulation
2	OUT	<i>OUT.</i> Connects to the MOSFET gate.
3	VCC	<i>VCC.</i> Supply pin for stable IC operation ZCD signal detection used for accurate PFC function.
4	RT	<i>RT.</i> Programmable operating frequency using external resistor and the IC has pre-fixed frequency when this pin is open or floating.
5	ADIM	<i>Analog Dimming.</i> Connect to the internal current source and can change the output current using an external resistor. If ADIM is not used, it is recommended to connect a 0.1 μ F bypass capacitor between the ADIM and GND.
6	GND	<i>GROUND.</i> Ground for the IC.
7	NC	No Connection
8	HV	<i>High Voltage.</i> Connect to the high voltage line and supply current to the IC

ABSOLUTE MAXIMUM RATINGS

Symbol	Parameter	Min	Max	Unit	
V _{CC}	IC Supply Voltage	-	20	V	
HV	High Voltage Sensing	-	500	V	
I _{O+} /I _{O-}	Peak Drive Output Current (Sourcing / Sinking)	-	250	mA	
V _{ADIM}	Analog Dimming	-	5	V	
V _{RT}	RT Pin Voltage	-	5	V	
V _{CS}	Allowable Current Sensing Detection Voltage	-	5	V	
T _A	Operating Ambient Temperature Range	-40	+125	°C	
T _J	Operating Junction Temperature	-40	+150	°C	
T _{STG}	Storage Temperature Range	-65	+150	°C	
θ_{JA}	Thermal Resistance Junction-Air (Notes 1, 2)	-	135	°C/W	
P _D	Power Dissipation	-	660	mW	
ESD	Electrostatic Discharge Capability	Human Body Model, JESD22-A114	-	2000	V
		Charged Device Model, JESD22-C101	-	1000	

Stresses exceeding those listed in the Maximum Ratings table may damage the device. If any of these limits are exceeded, device functionality should not be assumed, damage may occur and reliability may be affected.

1. Thermal resistance test board. Size: 76.2 mm x 114.3 mm x 1.6 mm (1S0P); JEDEC standard: JESD51-2, JESD51-3.
2. Assume no ambient airflow.

FL7701

ELECTRICAL CHARACTERISTICS (Typical values are at $T_A = +25^\circ\text{C}$. Specifications to -40°C ~ 125°C are guaranteed by design based on final characterization results.)

Symbol	Parameter	Conditions	Min	Typ	Max	Unit
--------	-----------	------------	-----	-----	-----	------

V_{CC} BIAS SECTION

V _{CC}	VCC Regulator Output Voltage	V _{HV} = 100 V _{DC}	14.0	15.5	17.0	V
V _{CCST+}	UVLO Positive Going Threshold	V _{CC} Increasing	12	13	14	V
V _{CCST-}	UVLO Negative Going Threshold	V _{CC} Decreasing	7	8	9	V
V _{CCHY}	UVLO Hysteresis		4	5	6	V
I _{HV}	HV Pin Current	V _{HV} = 100 V _{DC} , C _L = 150 pF, RT = Open	-	0.85	1.10	mA
I _{ST}	Startup Current		-	120	150	μA

SWITCHING SECTION

f _{OSC}	Operating Frequency	R _T = 5.95 kΩ	200	250	300	kHz
		R _T = 87 kΩ	16	20	24	kHz
		R _T Open	40.5	45.0	49.5	kHz
t _{MIN}	Minimum On Time		-	400	-	ns
D _{MAX}	Maximum Duty Cycle		-	50	-	%
t _{LEB}	Leading Edge Blanking Time (Note 3)		-	350	-	ns
V _{RT}	Voltage Reference of RT Pin		-	1.5	-	V

SOFT-START SECTION

t _{SS}	Soft-Start Time (Note 3)	DC Mode	48	60	72	ms
		AC Mode	-	7	-	Periods

REFERENCE SECTION

V _{CS1}	Internal Reference Voltage of CS Pin	DC Mode	0.354	0.365	0.376	V
V _{CS2}		AC Mode (Note 3)	0.485	0.500	0.515	

PROTECTION SECTION

OVP _{VCC}	Over-Voltage Protection on VCC Pin		17.7	18.7	19.7	V
V _{AOCP}	Abnormal OCP Level at CS Pin (Note 3)		-	2.5	-	V
t _{AOCP}	Abnormal Detection Time (Note 3)		-	70	-	ns
t _{TSDH}	Thermal Shutdown Threshold (Note 3)		140	150	-	°C
t _{TSDHY}	Thermal Shutdown Threshold Hysteresis (Note 3)		-	50	-	°C

DIMMING SECTION

V _{ADIM(ST+)}	Analog Dimming Positive Going Threshold (Note 3)		3.15	3.50	3.85	V
V _{ADIM(ST-)}	Analog Dimming Negative Going Threshold (Note 3)		-	0.50	0.75	V
I _{AD}	Internal Current Source for ADIM Pin		9	12	15	μA

Product parametric performance is indicated in the Electrical Characteristics for the listed test conditions, unless otherwise noted. Product performance may not be indicated by the Electrical Characteristics if operated under different conditions.

3. These parameters, although guaranteed, are not 100% tested in production.

FUNCTIONAL DESCRIPTION

The FL7701 is a basic PWM controller for buck converter topology in Continuous Conduction Mode (CCM) with intelligent PFC function using a digital control algorithm. The FL7701 has an internal self-biasing circuit that uses the high-voltage switching device. The IC does not need an auxiliary powering path to the VCC pin typical in flyback control ICs or PSR product family.

When the input voltage applied to the HV pin is over 25 V to 500 V, the FL7701 maintains a 15.5 V DC voltage at the VCC pin for stable operation. The FL7701 has UVLO block functions such that when the VCC voltage rises higher than V_{CCST+} , the internal UVLO block releases and starts operation. Otherwise the VCC goes down to the V_{CCST-} and IC operation stops. Normally, the hysteresis function provides stable operation even if the input voltage is operating under the very noisy or unstable circumstances.

The FL7701 has a smart internal digital block for determining input condition: AC or DC. When an AC source with 50 Hz or 60 Hz is applied to the IC, the IC automatically changes its internal reference signal, which is similar to input signal, for creating high power factor. Otherwise, once the DC source connects to the IC, the internal reference immediately changes to DC.

Soft-Start Function

The FL7701 has an internal soft-start function to reduce inrush current at startup. When the IC starts operation following an internal sequence, the internal reference slowly increases for a pre-determined fixed time. After this transient period, the internal reference goes to a steady-state level. In this time, the IC continually tries to find phase information from the VCC pin. If the IC succeeds in getting phase information, it automatically follows a similar shape reference made during the transient times, 7 periods. If not, the IC has a DC reference level.

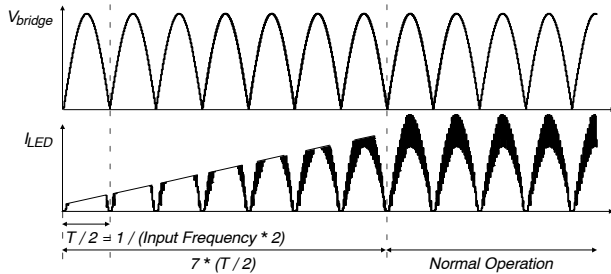

Figure 4. Soft Starting Function in AC Input Mode

Internal PFC Function: How to Achieve High Power Factor

The FL7701 has a simple, but smart, internal PFC function that does not require additional detection pins for detecting input phase information or an electrolytic capacitor for supply voltage stabilization. For achieving high PF, the FL7701 does not use the rectification capacitor after the bridge diode. This is important because the IC

instead uses fluctuation in the signal on the VCC pin. Basically, the VCC pin, which supplies power for the IC, has voltage ripple as well as the rectification voltage after bridge, changing voltage level according to the VCC capacitor value. Using this kind of voltage fluctuation on the VCC pin, the IC can detect the time reference and create the internal ZCD signal.

For precise and reliable internal reference for input voltage signal, the FL7701 uses a digital technique (sigma/delta modulation) and creates a new internal signal (DAC_OUT) that has the same phase as the input voltage, as shown in Figure 5. This signal enters the final comparator and is compared with current information from the sensing resistor.

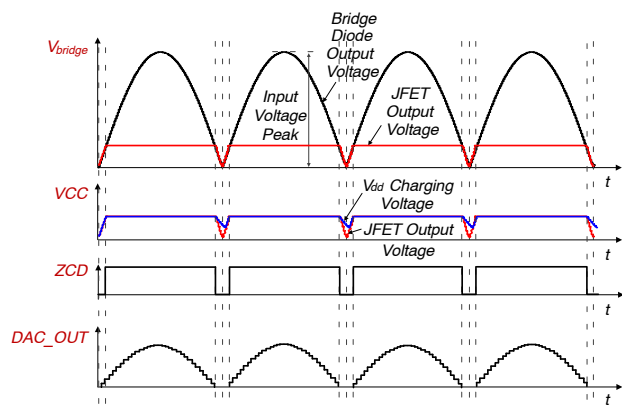

Figure 5. Internal PFC Function

Self-Biasing Function

The self-biasing function, using an HV device, can supply enough operating current to the IC and guarantee similar startup time across the whole input voltage range (80 V~308 V_{AC}). However, self-biasing has a weakness in high-voltage condition. Normally, the HV device acts as constant current source, so the internal HV device has power loss when high input voltage connects to the HV pin. This power loss is proportional to input voltage. To reduce this power loss, one of the possible solutions is an additional resistor between the input voltage source and the HV pin, as shown in Figure 6.

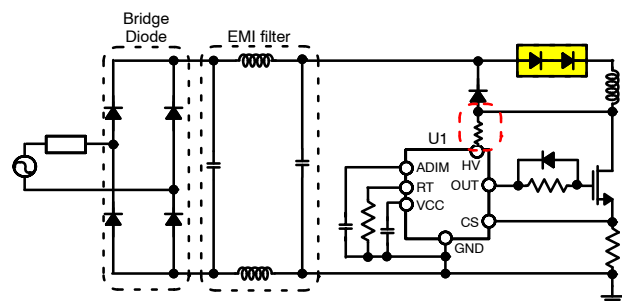

Figure 6. High-Voltage Application

Dimming Function

The FL7701 uses the ADIM pin for analog or 0 V to 10 V dimming by using a resistive divider. The peak voltage of internal reference, which is DAC_OUT signal in Figure 5, is changed by the V_{ADIM} level, as shown in Figure 7, and has different peak level according to the operating mode.

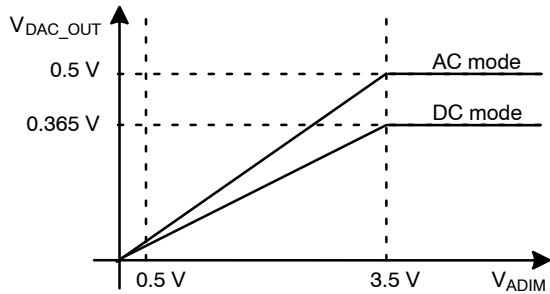

Figure 7. V_{ADIM} vs. V_{DAC_OUT(peak)}

Inductor Design

The FL7701 prefixed internal duty ratio range is below 50%, or around 400 ns, from timing point of view. The range is dependent on the input voltage and LED numbers in its string.

Minimum duty is calculated as:

$$D_{min} = \frac{n \cdot V_f}{\eta \cdot V_{in(max)}} \quad (eq. 1)$$

where:

η is efficiency of system;

$V_{IN(max)}$ is maximum input voltage;

V_f is forward drop voltage of LED; and

n is LED number in series connection.

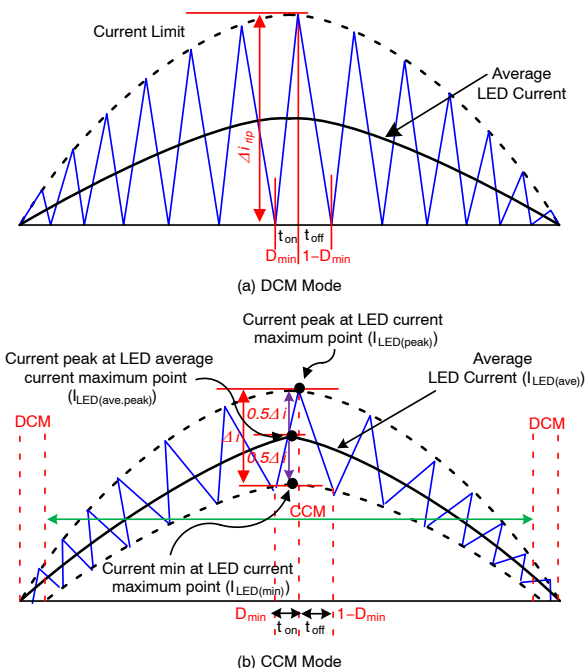

Figure 8. DCM and CCM Operation

In DCM Mode, inductance is:

$$L_m = \frac{n \cdot V_f \cdot (1 - D_{min})}{f_s \cdot \Delta i_{rip}} \quad [H] \quad (eq. 2)$$

If the peak current is fixed at 350 mApk, the formula for the peak current is:

$$I_{LED(ave,peak)} = \Delta i_{con} + \frac{\Delta i_{rip}}{2} \quad [A] \quad (eq. 3)$$

In FL7701, the LED RMS current determines the inductance parameter. To drive for CCM Mode, define LED RMS current first, as:

$$I_{LED(rms)} = \frac{I_{LED(ave,peak)}}{\sqrt{2}} \quad [A] \quad (eq. 4)$$

Substituting Equation (2) for Equation (4), the inductance of inductor is obtained.

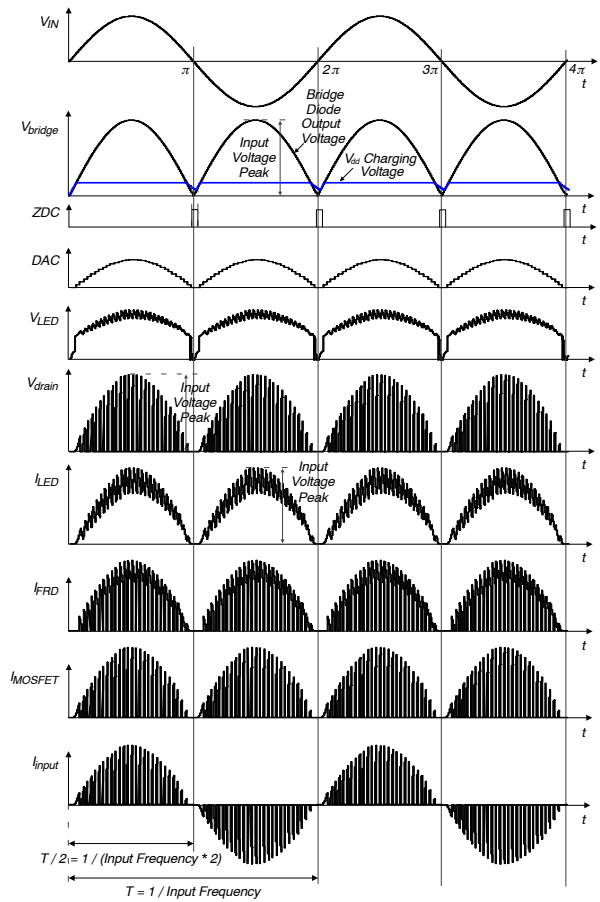

Figure 9. Typical Performance Characteristics

TYPICAL CHARACTERISTICS

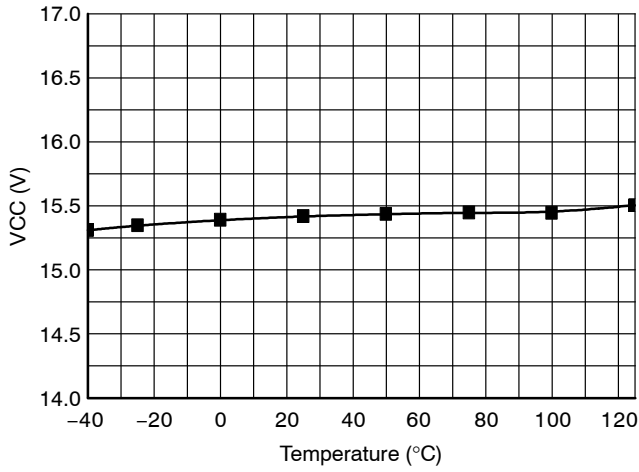

Figure 12. V_{CC} vs. Temperature

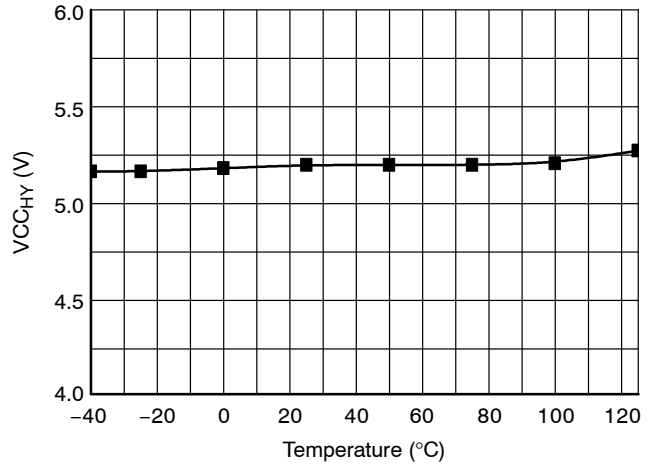

Figure 13. $V_{CC_{HY}}$ vs. Temperature

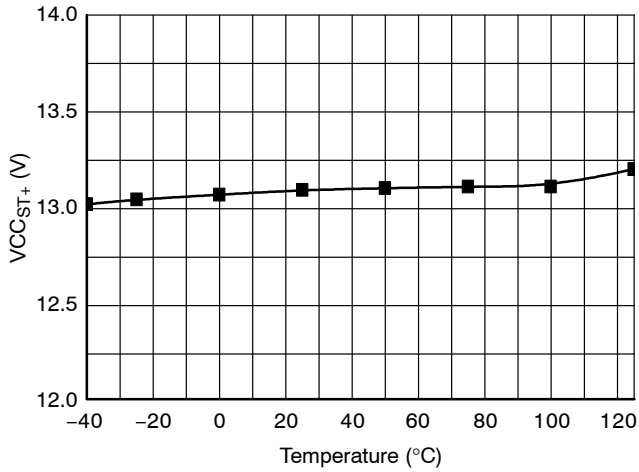

Figure 14. $V_{CC_{ST+}}$ vs. Temperature

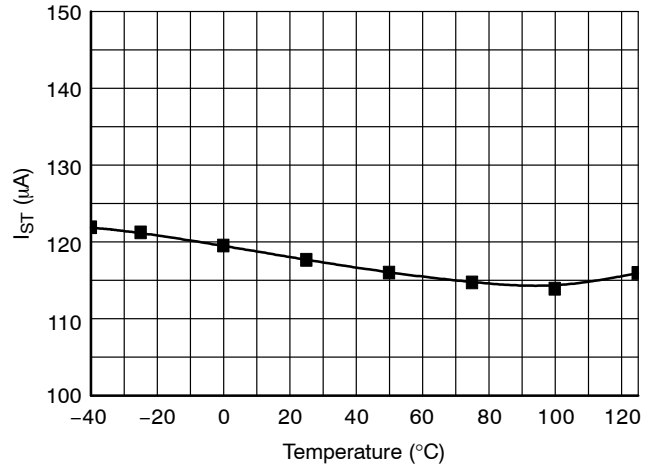

Figure 15. I_{ST} vs. Temperature

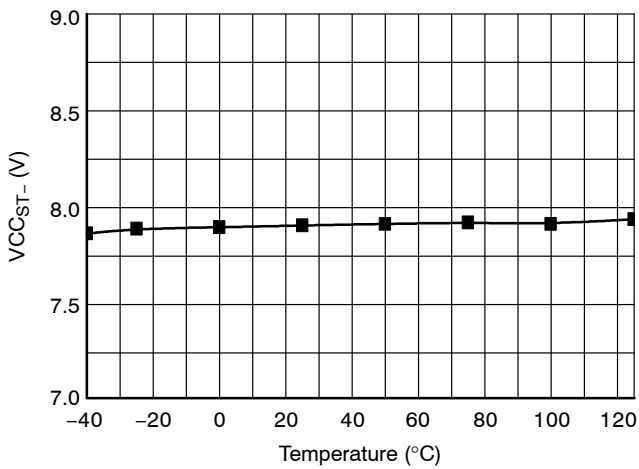

Figure 16. $V_{CC_{ST-}}$ vs. Temperature

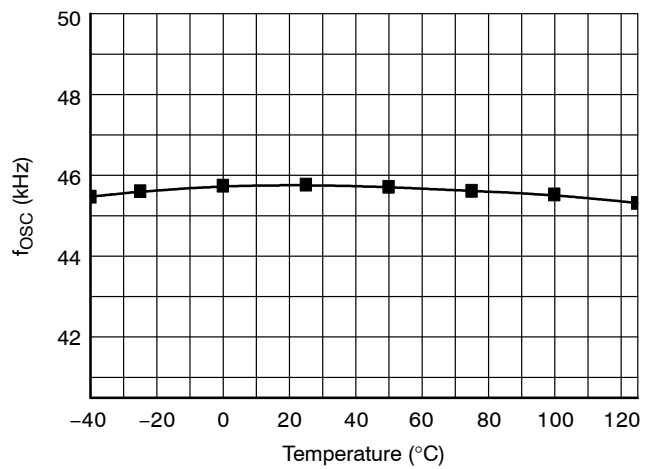

Figure 17. f_{OSC} vs. Temperature ($R_t = \text{Open}$)

TYPICAL CHARACTERISTICS (continued)

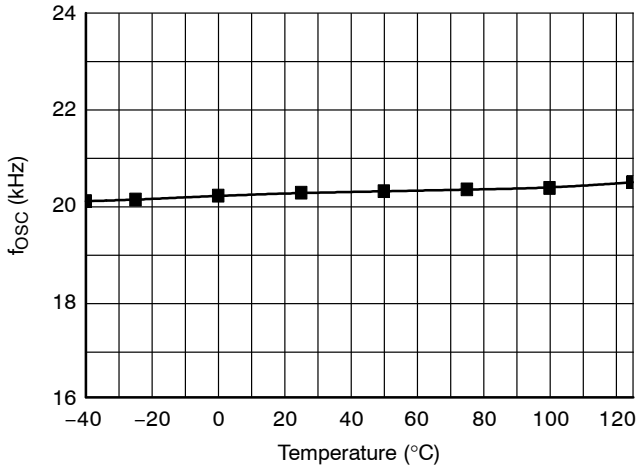

Figure 18. f_{OSC} vs. Temperature ($R_t = 87\text{ k}\Omega$)

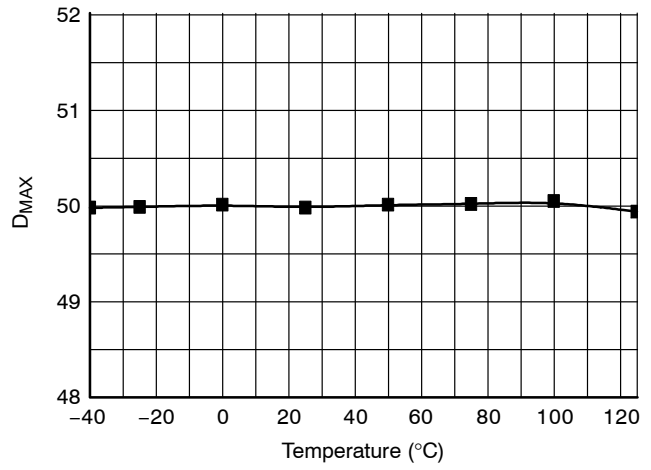

Figure 19. D_{MAX} vs. Temperature

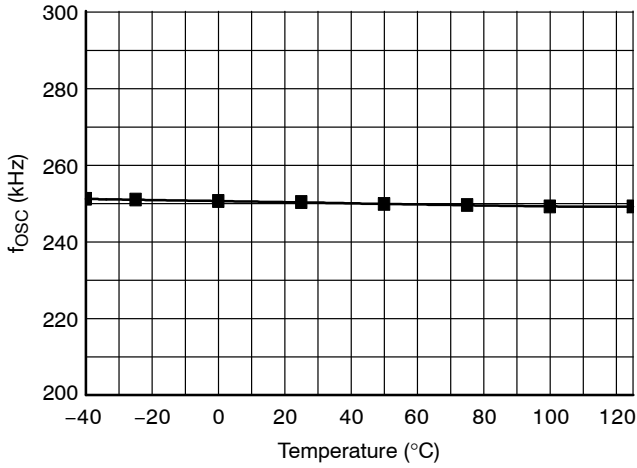

Figure 20. f_{OSC} vs. Temperature ($R_t = 5.95\text{ k}\Omega$)

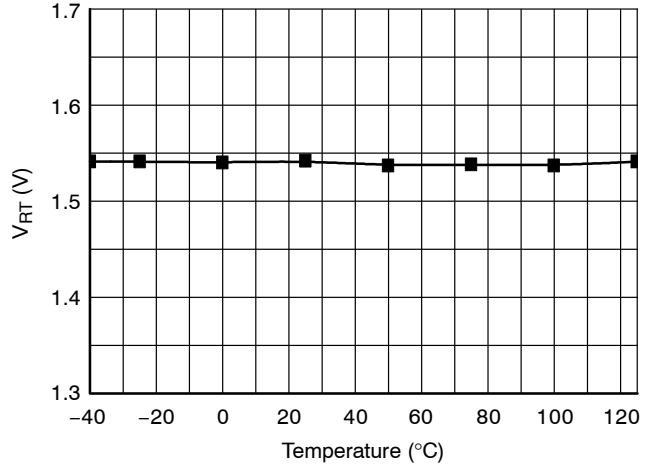

Figure 21. V_{RT} vs. Temperature

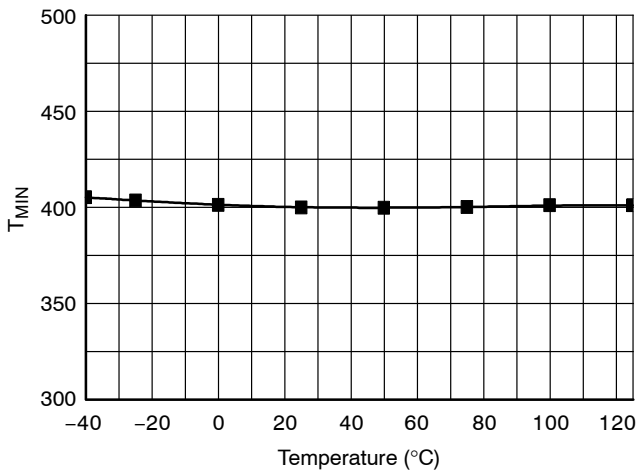

Figure 22. t_{MIN} vs. Temperature

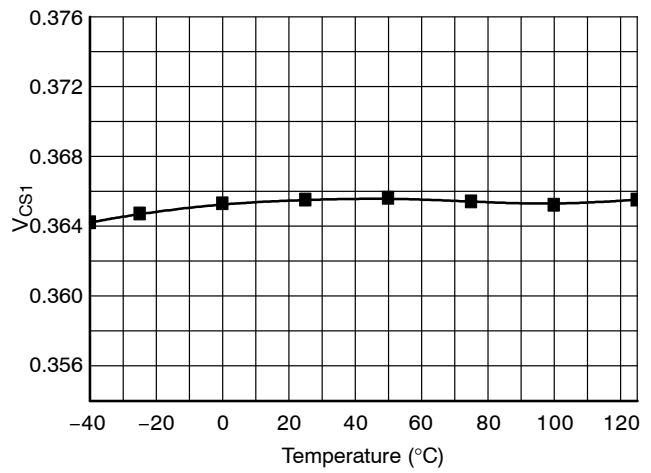

Figure 23. V_{CS1} vs. Temperature

FL7701

TYPICAL CHARACTERISTICS (continued)

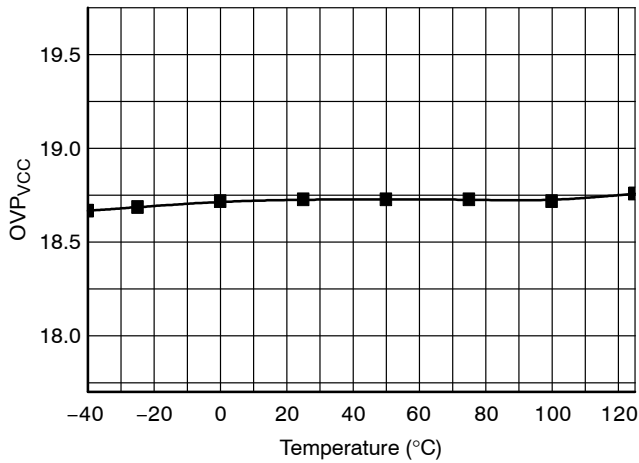

Figure 24. OVP_{VCC} vs. Temperature

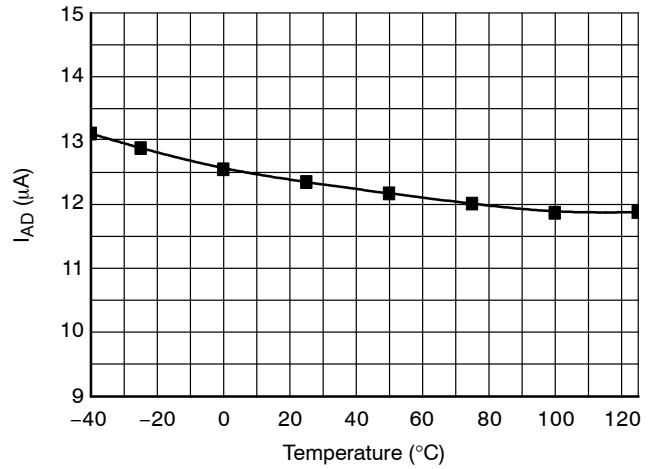

Figure 25. I_{AD} vs. Temperature

ORDERING INFORMATION

Part Number	Operating Temperature Range	Package	Shipping [†]
FL7701MX	-40°C to +125°C	8-Lead, Small Outline Integrated Circuit (SOIC), JEDEC MS-012, .150-inch Narrow Body (Pb-Free)	2500 Units / Tape & Reel

[†]For information on tape and reel specifications, including part orientation and tape sizes, please refer to our Tape and Reel Packaging Specifications Brochure, BRD8011/D.

MECHANICAL CASE OUTLINE

PACKAGE DIMENSIONS

ON Semiconductor®



SOIC8
CASE 751EB
ISSUE A

DATE 24 AUG 2017

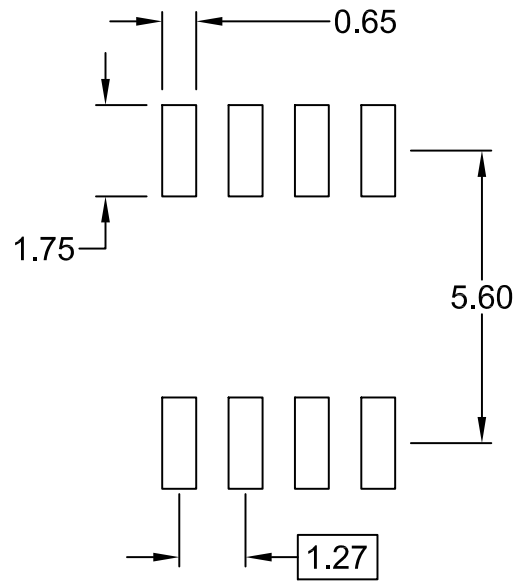
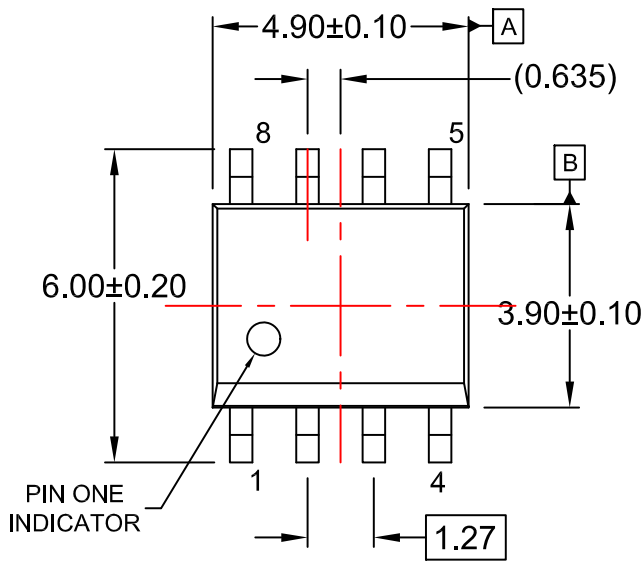

⊕ 0.25 (M) C B A

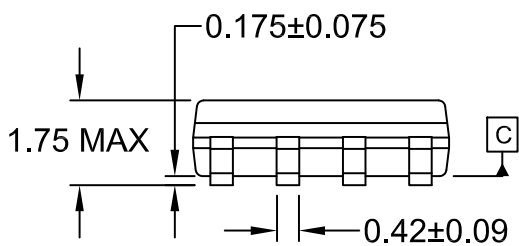

⌒ 0.10

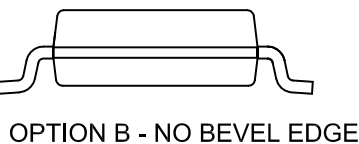
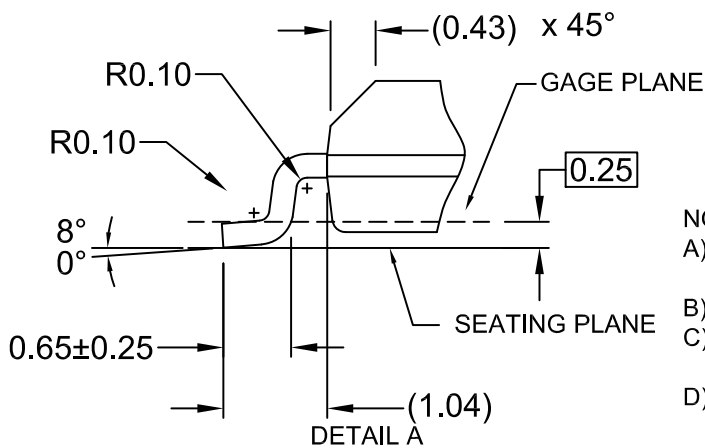
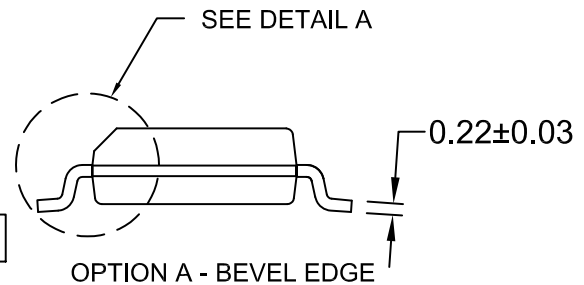

NOTES:

- A) THIS PACKAGE CONFORMS TO JEDEC MS-012, VARIATION AA.
- B) ALL DIMENSIONS ARE IN MILLIMETERS.
- C) DIMENSIONS DO NOT INCLUDE MOLD FLASH OR BURRS.
- D) LANDPATTERN STANDARD: SOIC127P600X175-8M

DOCUMENT NUMBER:	98AON13735G	Electronic versions are uncontrolled except when accessed directly from the Document Repository. Printed versions are uncontrolled except when stamped "CONTROLLED COPY" in red.
DESCRIPTION:	SOIC8	PAGE 1 OF 1

ON Semiconductor and are trademarks of Semiconductor Components Industries, LLC dba ON Semiconductor or its subsidiaries in the United States and/or other countries. ON Semiconductor reserves the right to make changes without further notice to any products herein. ON Semiconductor makes no warranty, representation or guarantee regarding the suitability of its products for any particular purpose, nor does ON Semiconductor assume any liability arising out of the application or use of any product or circuit, and specifically disclaims any and all liability, including without limitation special, consequential or incidental damages. ON Semiconductor does not convey any license under its patent rights nor the rights of others.

onsemi, **Onsemi**, and other names, marks, and brands are registered and/or common law trademarks of Semiconductor Components Industries, LLC dba "**onsemi**" or its affiliates and/or subsidiaries in the United States and/or other countries. **onsemi** owns the rights to a number of patents, trademarks, copyrights, trade secrets, and other intellectual property. A listing of **onsemi**'s product/patent coverage may be accessed at www.onsemi.com/site/pdf/Patent-Marking.pdf. **onsemi** reserves the right to make changes at any time to any products or information herein, without notice. The information herein is provided "as-is" and **onsemi** makes no warranty, representation or guarantee regarding the accuracy of the information, product features, availability, functionality, or suitability of its products for any particular purpose, nor does **onsemi** assume any liability arising out of the application or use of any product or circuit, and specifically disclaims any and all liability, including without limitation special, consequential or incidental damages. Buyer is responsible for its products and applications using **onsemi** products, including compliance with all laws, regulations and safety requirements or standards, regardless of any support or applications information provided by **onsemi**. "Typical" parameters which may be provided in **onsemi** data sheets and/or specifications can and do vary in different applications and actual performance may vary over time. All operating parameters, including "Typicals" must be validated for each customer application by customer's technical experts. **onsemi** does not convey any license under any of its intellectual property rights nor the rights of others. **onsemi** products are not designed, intended, or authorized for use as a critical component in life support systems or any FDA Class 3 medical devices or medical devices with a same or similar classification in a foreign jurisdiction or any devices intended for implantation in the human body. Should Buyer purchase or use **onsemi** products for any such unintended or unauthorized application, Buyer shall indemnify and hold **onsemi** and its officers, employees, subsidiaries, affiliates, and distributors harmless against all claims, costs, damages, and expenses, and reasonable attorney fees arising out of, directly or indirectly, any claim of personal injury or death associated with such unintended or unauthorized use, even if such claim alleges that **onsemi** was negligent regarding the design or manufacture of the part. **onsemi** is an Equal Opportunity/Affirmative Action Employer. This literature is subject to all applicable copyright laws and is not for resale in any manner.

PUBLICATION ORDERING INFORMATION

LITERATURE FULFILLMENT:

Email Requests to: orderlit@onsemi.com

onsemi Website: www.onsemi.com

TECHNICAL SUPPORT

North American Technical Support:

Voice Mail: 1 800-282-9855 Toll Free USA/Canada

Phone: 011 421 33 790 2910

Europe, Middle East and Africa Technical Support:

Phone: 00421 33 790 2910

For additional information, please contact your local Sales Representative