

5V/3.3V Dual Differential 2:1 Multiplexer

Features

- 3.3V and 5V Power Supply Option
- 440 ps Typical Propagation Delay
- Separate and Common Select
- High Bandwidth Output Transitions
- Internal 75 k Ω Input Pull Down Resistors
- Available in 20-Pin SOIC Package

General Description

The SY100EL56V is a dual, fully differential 2:1 multiplexer. The differential data path makes the device ideal for multiplexing low skew clock or other skew sensitive signals. Multiple VBB pins are provided to ease AC coupling input signals.

The device features both individual and common select inputs to address both data path and random logic applications.

The differential inputs have special circuitry which ensures device stability under open input conditions. When both differential inputs are left open the D input will pull down to V_{EE} , the /D input will bias around $V_{CC}/2$ forcing the Q output LOW.

Package Type

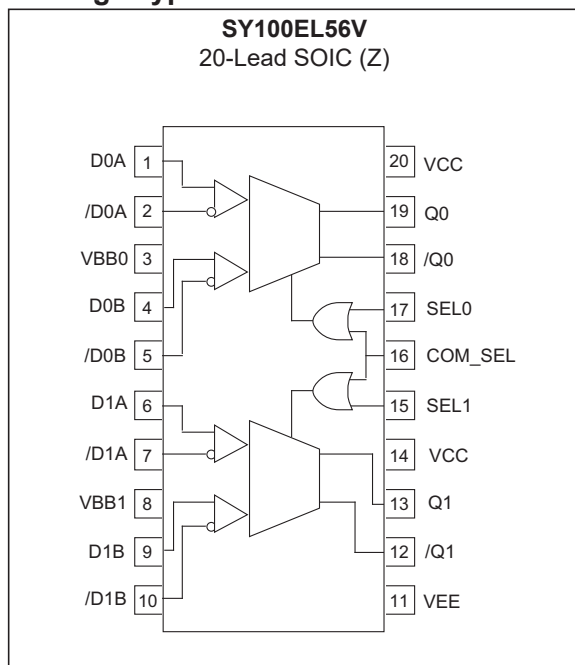

SY100EL56V

1.0 ELECTRICAL CHARACTERISTICS

Absolute Maximum Ratings †

PECL Power Supply Voltage (V_{CC}) (Note 1)	+8V
NECL Power Supply Voltage (V_{EE}) (Note 2)	-8V
PECL Mode Input Voltage (V_{IN}) (Note 3)	+6V
NECL Mode Input Voltage (V_{IN}) (Note 4)	-6V
Continuous Output Current (I_{OUT})	50 mA
Surge Output Current (I_{OUT})	100 mA
ESD Rating (Note 5)	>1.5 kV

† **Notice:** Stresses above those listed under “Absolute Maximum ratings” may cause permanent damage to the device. Exposure to maximum rating conditions for extended periods may affect device reliability.

Note 1: $V_{EE} = 0V$.

2: $V_{CC} = 0V$.

3: $V_{EE} = 0V, V_{IN} \leq V_{CC}$.

4: $V_{CC} = 0V, V_{IN} \geq V_{EE}$.

5: Mil Std. 883 Human Body Model, all pins.

DC ELECTRICAL CHARACTERISTICS

Electrical Characteristics: $V_{CC} = 3.0V$ to $5.5V$, $V_{EE} = 0V$ or $V_{EE} = -5.5V$ to $-3.0V$, $V_{CC} = 0V$; $T_A = -40^{\circ}C$ to $+85^{\circ}C$, unless otherwise stated. (Note 1)

Parameter	Symbol	Min.	Typ.	Max.	Units	Conditions
Power Supply Current	I_{EE}	—	20	24	mA	—
Output High Voltage (Note 2)	V_{OH}	$V_{CC} - 1.085$	$V_{CC} - 1.005$	$V_{CC} - 0.88$	V	$T_A = -40^{\circ}C$
		$V_{CC} - 1.025$	$V_{CC} - 0.955$	$V_{CC} - 0.88$		$T_A = 0^{\circ}C$ to $+85^{\circ}C$
Output Low Voltage (Note 2)	V_{OL}	$V_{CC} - 1.830$	$V_{CC} - 1.695$	$V_{CC} - 1.555$	V	$T_A = -40^{\circ}C$
		$V_{CC} - 1.810$	$V_{CC} - 1.705$	$V_{CC} - 1.620$		$T_A = 0^{\circ}C$ to $+85^{\circ}C$
Input High Voltage (Single-Ended)	V_{IH}	$V_{CC} - 1.165$	—	$V_{CC} - 0.880$	V	—
Input Low Voltage (Single-Ended)	V_{IL}	$V_{CC} - 1.810$	—	$V_{CC} - 1.475$	V	—
Output Reference Voltage	V_{BB}	$V_{CC} - 1.38$	—	$V_{CC} - 1.26$	V	—
Common Mode Range (Note 3)	V_{IHCMR}	$V_{EE} + 1.3$	—	$V_{CC} - 0.4$	V	$T_A = -40^{\circ}C$, $V_{PP} < 500$ mV
		$V_{EE} + 1.2$	—	$V_{CC} - 0.4$		$T_A = 0^{\circ}C$ to $85^{\circ}C$, $V_{PP} < 500$ mV
		$V_{EE} + 1.5$	—	$V_{CC} - 0.4$		$T_A = -40^{\circ}C$, $V_{PP} \geq 500$ mV
		$V_{EE} + 1.4$	—	$V_{CC} - 0.4$		$T_A = 0^{\circ}C$ to $85^{\circ}C$, $V_{PP} \geq 500$ mV
Input Sensitivity (Note 4)	V_{PP} (DC)	50	—	—	mV	—
Input High Current	I_{IH}	—	—	150	μA	—
Input Low Current	I_{IL}	0.5	—	—	μA	D, SEL, COM_SEL
		-300	—	—	μA	/D

- Note 1:** Devices are designed to meet the DC specifications shown in the above table after thermal equilibration has been established. The circuit is in a test socket or mounted on a printed circuit board and transverse airflow greater than 500 lfpm is maintained.
- 2:** Outputs are terminated through a 50Ω resistor to $V_{CC} - 2.0V$.
- 3:** The CMR range is referenced to the most positive side of the differential input voltage. Normal operation is obtained if the high level falls within the specified range and the peak-to-peak voltage lies between 150 mV and 1V.
- 4:** Differential input voltage required to obtain a full ECL swing on the outputs.

SY100EL56V

AC ELECTRICAL CHARACTERISTICS

Electrical Characteristics: $V_{CC} = +3.0V$ to $+5.5V$, $V_{EE} = 0V$ or $V_{EE} = -5.5V$ to $-3.02V$, $V_{CC} = 0V$; $T_A = -40^{\circ}C$ to $+85^{\circ}C$, $R_L = 50\Omega$ to $V_{CC} - 2V$; unless otherwise stated.

Parameter	Symbol	Min.	Typ.	Max.	Units	Conditions
Propagation Delay D to Q (Differential)	t_{PLH}, t_{PHL}	340	—	540	ps	$T_A = -40^{\circ}C$
		350	—	550		$T_A = 0^{\circ}C$
		360	—	560		$T_A = +25^{\circ}C$
		380	—	580		$T_A = +85^{\circ}C$
Propagation Delay D to Q (Single-Ended)		290	—	590		$T_A = -40^{\circ}C$
		300	—	600		$T_A = 0^{\circ}C$
		310	—	610		$T_A = +25^{\circ}C$
Propagation Delay SEL, COM_SEL to Q		330	—	630		$T_A = +85^{\circ}C$
		430	—	730		$T_A = -40^{\circ}C$
		440	—	740		$T_A = 0^{\circ}C, +25^{\circ}C$
450	—	750	$T_A = +85^{\circ}C$			
Within Device Skew (Note 1)	t_{SKEW}	—	40	80	ps	—
Duty Cycle Skew (Note 2)		—	—	100		—
Input Swing (Note 3)	$V_{PP}(AC)$	150	—	1000	mV	—
Output Rise/Fall Time Q (20% to 80%)	t_r/t_f	200	—	540	ps	—

- Note 1:** Within-device skew defined as identical transitions on similar paths through a device.
Note 2: Duty cycle skew is the difference between a t_{PLH} and t_{PHL} propagation delay through a device.
Note 3: Input swing for which AC parameters are ensured.

TEMPERATURE SPECIFICATIONS

Parameters	Symbol	Min.	Typ.	Max.	Units	Conditions
Temperature Ranges						
Operating Temperature Range	T_A	-40	—	+85	°C	—
Storage Temperature	T_S	-65	—	+150	°C	—
Lead Temperature	T_{LEAD}	—	—	+260	°C	Soldering, 20 sec.
Package Thermal Resistance (SOIC)						
Junction-to-Ambient	θ_{JA}	—	90	—	°C/W	Still Air
		—	60	—		500 lfpm
Junction-to-Case	θ_{JC}	—	35	—	°C/W	—

SY100EL56V

2.0 PIN DESCRIPTIONS

The descriptions of the pins are listed in [Table 2-1](#).

TABLE 2-1: PIN FUNCTION TABLE

Pin Name	Description
D0A - D1A	Input Data A.
D0B - D1B	Input Data B.
SEL0 - SEL1	Individual Select Input.
COM_SEL	Common Select Input.
Q0 - Q1	True Outputs.
/Q0 - /Q1	Inverted Outputs.

2.1 Truth Table

TABLE 2-2: TRUTH TABLE

SEL	DATA
H	A
L	B

3.0 PACKAGING INFORMATION

3.1 Package Marking Information

20-Lead SOIC*



Example

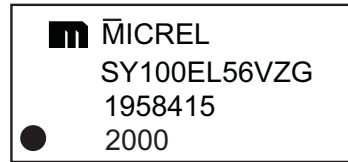

Legend:	XX...X	Product code or customer-specific information
	Y	Year code (last digit of calendar year)
	YY	Year code (last 2 digits of calendar year)
	WW	Week code (week of January 1 is week '01')
	NNN	Alphanumeric traceability code
	(e3)	Pb-free JEDEC® designator for Matte Tin (Sn)
	*	This package is Pb-free. The Pb-free JEDEC designator ((e3)) can be found on the outer packaging for this package.
	•, ▲, ▼	Pin one index is identified by a dot, delta up, or delta down (triangle mark).
Note:	In the event the full Microchip part number cannot be marked on one line, it will be carried over to the next line, thus limiting the number of available characters for customer-specific information. Package may or may not include the corporate logo.	
	Underbar (¯) and/or Overbar (¯) symbol may not be to scale.	

SY100EL56V

TITLE

20 LEAD SOICW PACKAGE OUTLINE & RECOMMENDED LAND PATTERN

DRAWING #	SOICW-20LD-PL-1	UNIT	INCH [MM]
-----------	-----------------	------	-----------

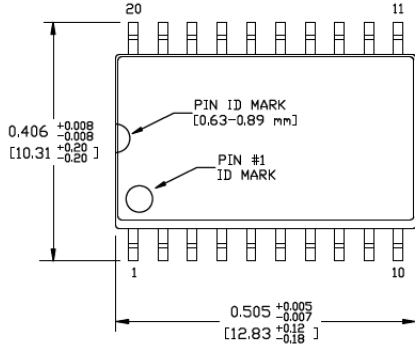

TOP VIEW
NOTE: 1, 2

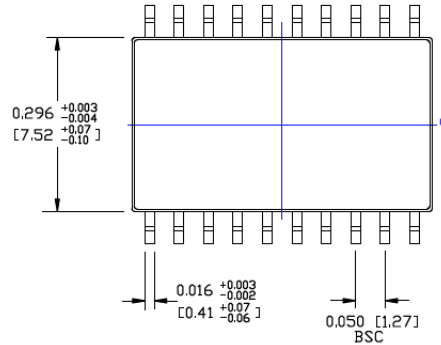

BOTTOM VIEW
NOTE: 1, 2

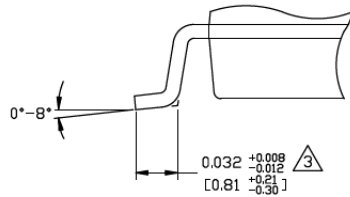

DETAIL "A"

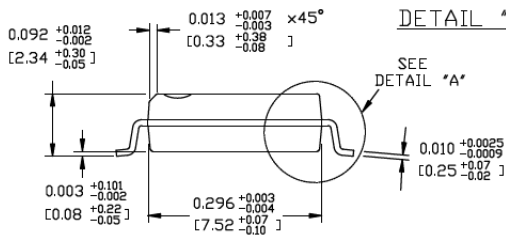

END VIEW
NOTE: 1, 2, 3

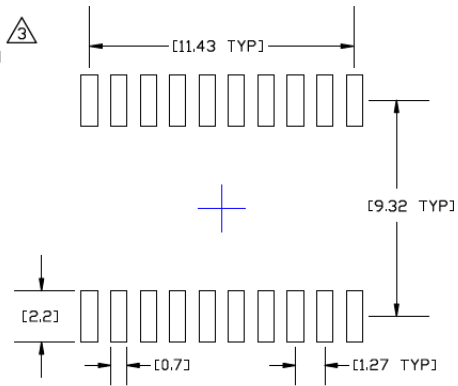

RECOMMENDED LAND PATTERN

NOTES:

1. DIMENSIONS ARE IN INCHES[MM].
2. CONTROLLING DIMENSION: INCHES.
3. DIMENSION DOES NOT INCLUDE MOLD FLASH OR PROTRUSIONS, EITHER OF WHICH SHALL NOT EXCEED 0.006[0.15] PER SIDE.

Note: For the most current package drawings, please see the Microchip Packaging Specification located at <http://www.microchip.com/packaging>.

APPENDIX A: REVISION HISTORY

Revision A (August 2019)

- Converted Micrel document SY100EL56V to Microchip data sheet DS20006242A.
- Minor text changes throughout.

SY100EL56V

NOTES:

PRODUCT IDENTIFICATION SYSTEM

To order or obtain information, e.g., on pricing or delivery, contact your local Microchip representative or sales office.

<u>PART NO.</u>	<u>-XX</u>	<u>X</u>	<u>X</u>	<u>-XX</u>	Examples:
Device	Supply Voltage Range	Package	Temperature Range	Special Processing	
Device:	SY100EL56:	Dual Differential 2:1 Multiplexer			a) SY100EL56VZG: SY100EL56, 3.3V/5V, 20-Lead SOIC, -40°C to +85°C, 38/Tube
Supply Voltage Range:	V	=	3.3V/5V		b) SY100EL56VZG-TR: SY100EL56, 3.3V/5V, 20-Lead, SOIC, -40°C to +85°C, 1,000/Reel
Package:	Z	=	20-Lead SOIC (Pb-Free NiPdAu)		
Temperature Range:	G	=	-40°C to +85°C		
Special Processing:	<blank>	=	38/Tube		
	TR	=	1,000/Reel		Note 1: Tape and Reel identifier only appears in the catalog part number description. This identifier is used for ordering purposes and is not printed on the device package. Check with your Microchip Sales Office for package availability with the Tape and Reel option.

SY100EL56V

NOTES:

Note the following details of the code protection feature on Microchip devices:

- Microchip products meet the specification contained in their particular Microchip Data Sheet.
- Microchip believes that its family of products is one of the most secure families of its kind on the market today, when used in the intended manner and under normal conditions.
- There are dishonest and possibly illegal methods used to breach the code protection feature. All of these methods, to our knowledge, require using the Microchip products in a manner outside the operating specifications contained in Microchip's Data Sheets. Most likely, the person doing so is engaged in theft of intellectual property.
- Microchip is willing to work with the customer who is concerned about the integrity of their code.
- Neither Microchip nor any other semiconductor manufacturer can guarantee the security of their code. Code protection does not mean that we are guaranteeing the product as “unbreakable.”

Code protection is constantly evolving. We at Microchip are committed to continuously improving the code protection features of our products. Attempts to break Microchip's code protection feature may be a violation of the Digital Millennium Copyright Act. If such acts allow unauthorized access to your software or other copyrighted work, you may have a right to sue for relief under that Act.

Information contained in this publication regarding device applications and the like is provided only for your convenience and may be superseded by updates. It is your responsibility to ensure that your application meets with your specifications. MICROCHIP MAKES NO REPRESENTATIONS OR WARRANTIES OF ANY KIND WHETHER EXPRESS OR IMPLIED, WRITTEN OR ORAL, STATUTORY OR OTHERWISE, RELATED TO THE INFORMATION, INCLUDING BUT NOT LIMITED TO ITS CONDITION, QUALITY, PERFORMANCE, MERCHANTABILITY OR FITNESS FOR PURPOSE. Microchip disclaims all liability arising from this information and its use. Use of Microchip devices in life support and/or safety applications is entirely at the buyer's risk, and the buyer agrees to defend, indemnify and hold harmless Microchip from any and all damages, claims, suits, or expenses resulting from such use. No licenses are conveyed, implicitly or otherwise, under any Microchip intellectual property rights unless otherwise stated.

Trademarks

The Microchip name and logo, the Microchip logo, Adaptec, AnyRate, AVR, AVR logo, AVR Freaks, BesTime, BitCloud, chipKIT, chipKIT logo, CryptoMemory, CryptoRF, dsPIC, FlashFlex, flexPWR, HELDO, IGLOO, JukeBlox, KeeLoq, Klear, LANCheck, LinkMD, maXStylus, maXTouch, MediaLB, megaAVR, Microsemi, Microsemi logo, MOST, MOST logo, MPLAB, OptoLyzer, PackeTime, PIC, picoPower, PICSTART, PIC32 logo, PolarFire, Prochip Designer, QTouch, SAM-BA, SenGenuity, SpyNIC, SST, SST Logo, SuperFlash, Symmetricom, SyncServer, Tachyon, TempTrackr, TimeSource, tinyAVR, UNI/O, Vectron, and XMEGA are registered trademarks of Microchip Technology Incorporated in the U.S.A. and other countries.

APT, ClockWorks, The Embedded Control Solutions Company, EtherSynch, FlashTec, Hyper Speed Control, HyperLight Load, IntelliMOS, Libero, motorBench, mTouch, Powermite 3, Precision Edge, ProASIC, ProASIC Plus, ProASIC Plus logo, Quiet-Wire, SmartFusion, SyncWorld, Temux, TimeCesium, TimeHub, TimePictra, TimeProvider, Vite, WinPath, and ZL are registered trademarks of Microchip Technology Incorporated in the U.S.A.

Adjacent Key Suppression, AKS, Analog-for-the-Digital Age, Any Capacitor, AnyIn, AnyOut, BlueSky, BodyCom, CodeGuard, CryptoAuthentication, CryptoAutomotive, CryptoCompanion, CryptoController, dsPICDEM, dsPICDEM.net, Dynamic Average Matching, DAM, ECAN, EtherGREEN, In-Circuit Serial Programming, ICSP, INICnet, Inter-Chip Connectivity, JitterBlocker, KlearNet, KlearNet logo, memBrain, Mindi, MiWi, MPASM, MPF, MPLAB Certified logo, MPLIB, MPLINK, MultiTRAK, NetDetach, Omniscient Code Generation, PICDEM, PICDEM.net, PICKit, PICtail, PowerSmart, PureSilicon, QMatrix, REAL ICE, Ripple Blocker, SAM-ICE, Serial Quad I/O, SMART-I.S., SQI, SuperSwitcher, SuperSwitcher II, Total Endurance, TSHARC, USBCheck, VariSense, ViewSpan, WiperLock, Wireless DNA, and ZENA are trademarks of Microchip Technology Incorporated in the U.S.A. and other countries.

SQTP is a service mark of Microchip Technology Incorporated in the U.S.A.

The Adaptec logo, Frequency on Demand, Silicon Storage Technology, and Symmcom are registered trademarks of Microchip Technology Inc. in other countries.

GestIC is a registered trademark of Microchip Technology Germany II GmbH & Co. KG, a subsidiary of Microchip Technology Inc., in other countries.

All other trademarks mentioned herein are property of their respective companies.

© 2019, Microchip Technology Incorporated, All Rights Reserved.

ISBN: 978-1-5224-4612-5

For information regarding Microchip's Quality Management Systems, please visit www.microchip.com/quality.



MICROCHIP

Worldwide Sales and Service

AMERICAS

Corporate Office
2355 West Chandler Blvd.
Chandler, AZ 85224-6199
Tel: 480-792-7200
Fax: 480-792-7277
Technical Support:
<http://www.microchip.com/support>
Web Address:
www.microchip.com

Atlanta

Duluth, GA
Tel: 678-957-9614
Fax: 678-957-1455

Austin, TX

Tel: 512-257-3370

Boston

Westborough, MA
Tel: 774-760-0087
Fax: 774-760-0088

Chicago

Itasca, IL
Tel: 630-285-0071
Fax: 630-285-0075

Dallas

Addison, TX
Tel: 972-818-7423
Fax: 972-818-2924

Detroit

Novi, MI
Tel: 248-848-4000

Houston, TX

Tel: 281-894-5983

Indianapolis

Noblesville, IN
Tel: 317-773-8323
Fax: 317-773-5453
Tel: 317-536-2380

Los Angeles

Mission Viejo, CA
Tel: 949-462-9523
Fax: 949-462-9608
Tel: 951-273-7800

Raleigh, NC

Tel: 919-844-7510

New York, NY

Tel: 631-435-6000

San Jose, CA

Tel: 408-735-9110
Tel: 408-436-4270

Canada - Toronto

Tel: 905-695-1980
Fax: 905-695-2078

ASIA/PACIFIC

Australia - Sydney
Tel: 61-2-9868-6733

China - Beijing
Tel: 86-10-8569-7000

China - Chengdu
Tel: 86-28-8665-5511

China - Chongqing
Tel: 86-23-8980-9588

China - Dongguan
Tel: 86-769-8702-9880

China - Guangzhou
Tel: 86-20-8755-8029

China - Hangzhou
Tel: 86-571-8792-8115

China - Hong Kong SAR
Tel: 852-2943-5100

China - Nanjing
Tel: 86-25-8473-2460

China - Qingdao
Tel: 86-532-8502-7355

China - Shanghai
Tel: 86-21-3326-8000

China - Shenyang
Tel: 86-24-2334-2829

China - Shenzhen
Tel: 86-755-8864-2200

China - Suzhou
Tel: 86-186-6233-1526

China - Wuhan
Tel: 86-27-5980-5300

China - Xian
Tel: 86-29-8833-7252

China - Xiamen
Tel: 86-592-2388138

China - Zhuhai
Tel: 86-756-3210040

ASIA/PACIFIC

India - Bangalore
Tel: 91-80-3090-4444

India - New Delhi
Tel: 91-11-4160-8631

India - Pune
Tel: 91-20-4121-0141

Japan - Osaka
Tel: 81-6-6152-7160

Japan - Tokyo
Tel: 81-3-6880-3770

Korea - Daegu
Tel: 82-53-744-4301

Korea - Seoul
Tel: 82-2-554-7200

Malaysia - Kuala Lumpur
Tel: 60-3-7651-7906

Malaysia - Penang
Tel: 60-4-227-8870

Philippines - Manila
Tel: 63-2-634-9065

Singapore
Tel: 65-6334-8870

Taiwan - Hsin Chu
Tel: 886-3-577-8366

Taiwan - Kaohsiung
Tel: 886-7-213-7830

Taiwan - Taipei
Tel: 886-2-2508-8600

Thailand - Bangkok
Tel: 66-2-694-1351

Vietnam - Ho Chi Minh
Tel: 84-28-5448-2100

EUROPE

Austria - Wels
Tel: 43-7242-2244-39
Fax: 43-7242-2244-393

Denmark - Copenhagen
Tel: 45-4450-2828
Fax: 45-4485-2829

Finland - Espoo
Tel: 358-9-4520-820

France - Paris
Tel: 33-1-69-53-63-20
Fax: 33-1-69-30-90-79

Germany - Garching
Tel: 49-8931-9700

Germany - Haan
Tel: 49-2129-3766400

Germany - Heilbronn
Tel: 49-7131-72400

Germany - Karlsruhe
Tel: 49-721-625370

Germany - Munich
Tel: 49-89-627-144-0
Fax: 49-89-627-144-44

Germany - Rosenheim
Tel: 49-8031-354-560

Israel - Ra'anana
Tel: 972-9-744-7705

Italy - Milan
Tel: 39-0331-742611
Fax: 39-0331-466781

Italy - Padova
Tel: 39-049-7625286

Netherlands - Drunen
Tel: 31-416-690399
Fax: 31-416-690340

Norway - Trondheim
Tel: 47-7288-4388

Poland - Warsaw
Tel: 48-22-3325737

Romania - Bucharest
Tel: 40-21-407-87-50

Spain - Madrid
Tel: 34-91-708-08-90
Fax: 34-91-708-08-91

Sweden - Gothenberg
Tel: 46-31-704-60-40

Sweden - Stockholm
Tel: 46-8-5090-4654

UK - Wokingham
Tel: 44-118-921-5800
Fax: 44-118-921-5820