

MOSFET – Dual P-Channel POWERTRENCH®

-20 V, -2.6 A, 142 mΩ

FDME1023PZT

Description

This device is designed specifically as a single package solution for the battery charges switch in cellular handset and other ultra-portable applications. It features two independent P-Channel MOSFETs with low on-state resistance for minimum conduction losses. When connected in the typical common source configuration, bi-directional current flow is possible.

The MicroFET 1.6x1.6 **Thin** package offers exceptional thermal performance for its physical size and is well suited to switching and linear mode applications.

Features

- Max $R_{DS(on)}$ = 142 mΩ at $V_{GS} = -4.5$ V, $I_D = -2.3$ A
- Max $R_{DS(on)}$ = 213 mΩ at $V_{GS} = -2.5$ V, $I_D = -1.8$ A
- Max $R_{DS(on)}$ = 331 mΩ at $V_{GS} = -1.8$ V, $I_D = -1.5$ A
- Max $R_{DS(on)}$ = 530 mΩ at $V_{GS} = -1.5$ V, $I_D = -1.2$ A
- Low Profile: 0.55 mm Maximum in the New Package MicroFET 1.6x1.6 **Thin**
- HBM ESD Protection Level > 1600 V (Note 3)
- This Device is Pb-Free, Halide Free and RoHS Compliant

Typical Applications

- Load Switch
- Battery Charging
- Battery Disconnect Switch

ABSOLUTE MAXIMUM RATINGS ($T_A = 25^\circ\text{C}$ unless otherwise noted)

Symbol	Parameter	Value	Unit
V_{DS}	Drain to Source Voltage	-20	V
V_{GS}	Gate to Source Voltage	±8	V
I_D	Drain Current – Continuous (Note 1a) – Pulsed	$T_A = 25^\circ\text{C}$ -2.6 -6	A
P_D	Power Dissipation for Single Operation – (Note 1a) – (Note 1b)	$T_A = 25^\circ\text{C}$ 1.4 $T_A = 25^\circ\text{C}$ 0.6	W
T_J, T_{STG}	Operating and Storage Junction Temperature Range	-55 to +150	°C

Stresses exceeding those listed in the Maximum Ratings table may damage the device. If any of these limits are exceeded, device functionality should not be assumed, damage may occur and reliability may be affected.

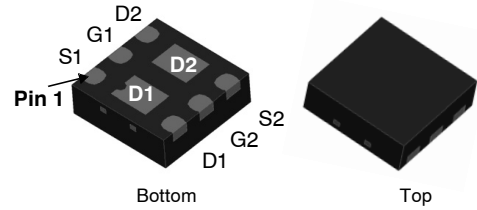

UDFN6 1.6 x 1.6 0.5P
(MicroFET™ 1.6 x 1.6 Thin)
CASE 517DW

ELECTRICAL CONNECTION

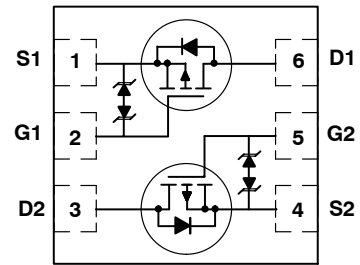

Dual P-Channel MOSFET
(Top View)

MARKING DIAGRAM

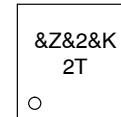

- &Z = Assembly Plant Code
- &2 = 2-Digit Date Code (Year and Week)
- &K = 2-Digit Lot Run Code
- 2T = Specific Device Code

ORDERING INFORMATION

See detailed ordering and shipping information on page 6 of this data sheet.

FDME1023PZT

THERMAL CHARACTERISTICS

Symbol	Parameter	Value	Unit
$R_{\theta JA}$	Thermal Resistance, Junction to Ambient (Single Operation) (Note 1a)	90	°C/W
$R_{\theta JA}$	Thermal Resistance, Junction to Ambient (Single Operation) (Note 1b)	195	

ELECTRICAL CHARACTERISTICS $T_A = 25^\circ\text{C}$ unless otherwise noted

Symbol	Parameter	Test Conditions	Min	Typ	Max	Units
Off Characteristics						
BV_{DSS}	Drain to Source Breakdown Voltage	$I_D = -250 \mu\text{A}$, $V_{GS} = 0 \text{ V}$	-20	-	-	V
$\frac{\Delta BV_{DSS}}{\Delta T_J}$	Breakdown Voltage Temperature Coefficient	$I_D = -250 \mu\text{A}$, referenced to 25°C	-	-12	-	mV/°C
I_{DSS}	Zero Gate Voltage Drain Current	$V_{DS} = -16 \text{ V}$, $V_{GS} = 0 \text{ V}$	-	-	-1	μA
I_{GSS}	Gate to Source Leakage Current	$V_{GS} = \pm 8 \text{ V}$, $V_{DS} = 0 \text{ V}$	-	-	± 10	μA
On Characteristics						
$V_{GS(th)}$	Gate to Source Threshold Voltage	$V_{GS} = V_{DS}$, $I_D = -250 \mu\text{A}$	-0.4	-0.6	-1.0	V
$\frac{\Delta V_{GS(th)}}{\Delta T_J}$	Gate to Source Threshold Voltage Temperature Coefficient	$I_D = -250 \mu\text{A}$, referenced to 25°C	-	2	-	mV/°C
$R_{DS(on)}$	Drain to Source On Resistance	$V_{GS} = -4.5 \text{ V}$, $I_D = -2.3 \text{ A}$	-	95	142	m Ω
		$V_{GS} = -2.5 \text{ V}$, $I_D = -1.8 \text{ A}$	-	120	213	
		$V_{GS} = -1.8 \text{ V}$, $I_D = -1.5 \text{ A}$	-	150	331	
		$V_{GS} = -1.5 \text{ V}$, $I_D = -1.2 \text{ A}$	-	190	530	m Ω
		$V_{GS} = -4.5 \text{ V}$, $I_D = -2.3 \text{ A}$, $T_J = 125^\circ\text{C}$	-	128	190	m Ω
g_{FS}	Forward Transconductance	$V_{DS} = -4.5 \text{ V}$, $I_D = -2.3 \text{ A}$	-	7	-	S
Dynamic Characteristics						
C_{iss}	Input Capacitance	$V_{DS} = -10 \text{ V}$, $V_{GS} = 0 \text{ V}$, $f = 1 \text{ MHz}$	-	305	405	pF
C_{oss}	Output Capacitance		-	55	75	pF
C_{rss}	Reverse Transfer Capacitance		-	50	75	pF
Switching Characteristics						
$t_{d(on)}$	Turn-On Delay Time	$V_{DD} = -10 \text{ V}$, $I_D = -1 \text{ A}$, $V_{GS} = -4.5 \text{ V}$, $R_{GEN} = 6 \Omega$	-	4.7	10	ns
t_r	Rise Time		-	4.8	10	ns
$t_{d(off)}$	Turn-Off Delay Time		-	33	53	ns
t_f	Fall Time		-	16	29	ns
Q_g	Total Gate Charge	$V_{DD} = -10 \text{ V}$, $I_D = -2.3 \text{ A}$, $V_{GS} = -4.5 \text{ V}$	-	5.5	7.7	nC
Q_{gs}	Gate to Source Gate Charge		-	0.6	-	nC
Q_{gd}	Gate to Drain "Miller" Charge		-	1.4	-	nC
Drain-Source Diode Characteristics						
V_{SD}	Source to Drain Diode Forward Voltage	$V_{GS} = 0 \text{ V}$, $I_S = -0.9 \text{ A}$ (Note 2)	-	-0.8	-1.2	V
t_{rr}	Reverse Recovery Time	$I_F = -2.3 \text{ A}$, $di/dt = 100 \text{ A}/\mu\text{s}$	-	16	29	ns
Q_{rr}	Reverse Recovery Charge		-	4.4	10	nC

Product parametric performance is indicated in the Electrical Characteristics for the listed test conditions, unless otherwise noted. Product performance may not be indicated by the Electrical Characteristics if operated under different conditions.

FDME1023PZT

NOTES:

1. $R_{\theta JA}$ is determined with the device mounted on a 1 in² pad 2 oz copper pad on a 1.5 x 1.5 in. board of FR-4 material. $R_{\theta JC}$ is guaranteed by design while $R_{\theta JA}$ is determined by the user's board design.

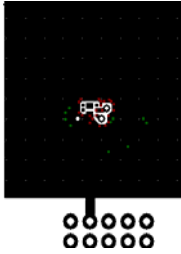

a. 90°C/W when mounted on
a 1 in² pad of 2 oz copper

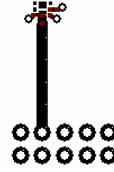

b. 195°C/W when mounted on
a minimum pad of 2 oz copper

2. Pulse Test : Pulse Width < 300 μ s, Duty Cycle < 2.0%
3. The diode connected between gate and source serves only as protection against ESD. No gate overvoltage rating is implied.

FDME1023PZT

TYPICAL CHARACTERISTICS ($T_J = 25^\circ\text{C}$ unless otherwise noted)

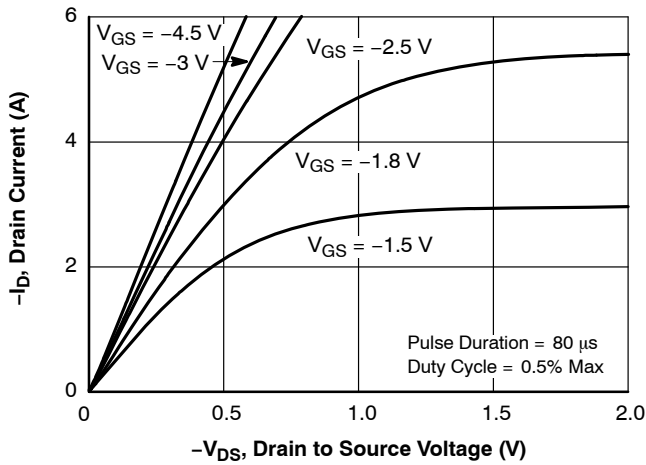

Figure 1. On Region Characteristics

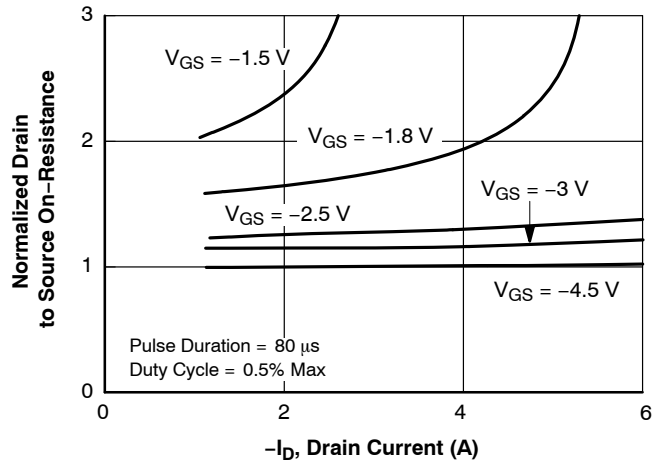

Figure 2. Normalized On-Resistance vs. Drain Current and Gate Voltage

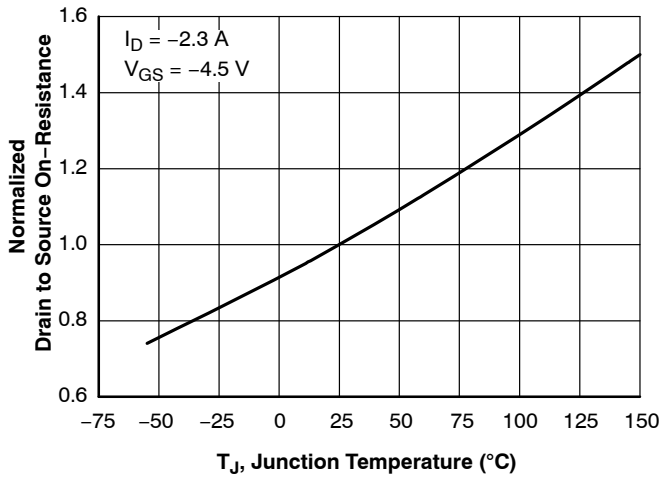

Figure 3. Normalized On Resistance vs. Junction Temperature

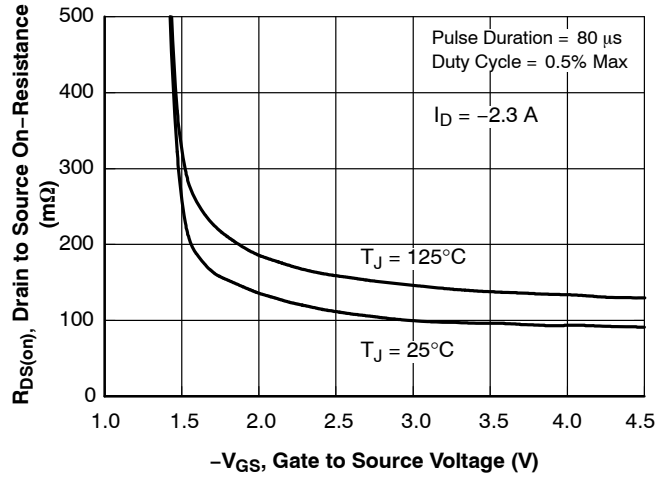

Figure 4. On-Resistance vs. Gate to Source Voltage

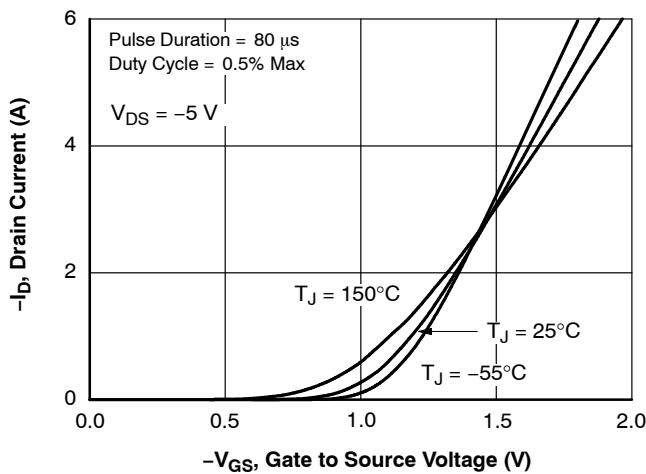

Figure 5. Transfer Characteristics

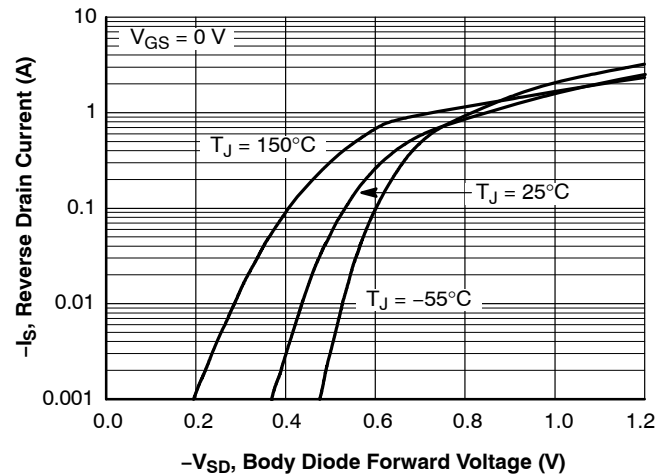

Figure 6. Source to Drain Diode Forward Voltage vs. Source Current

FDME1023PZT

TYPICAL CHARACTERISTICS ($T_J = 25^\circ\text{C}$ unless otherwise noted) (continued)

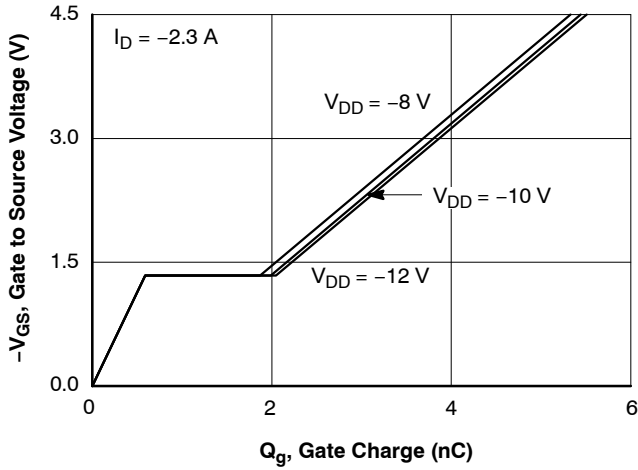

Figure 8. Gate Charge Characteristics

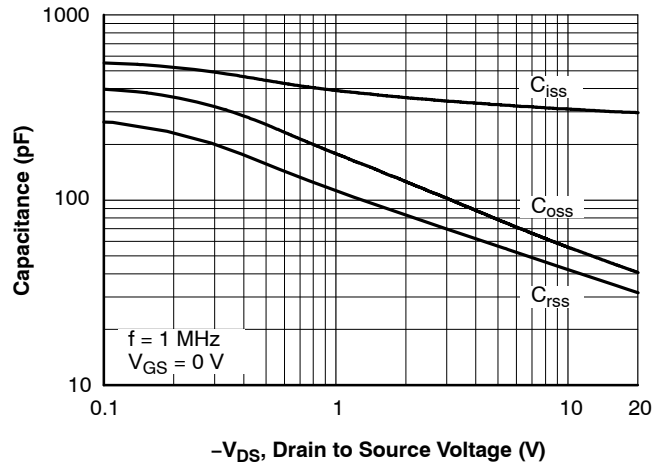

Figure 9. Capacitance vs. Drain to Source Voltage

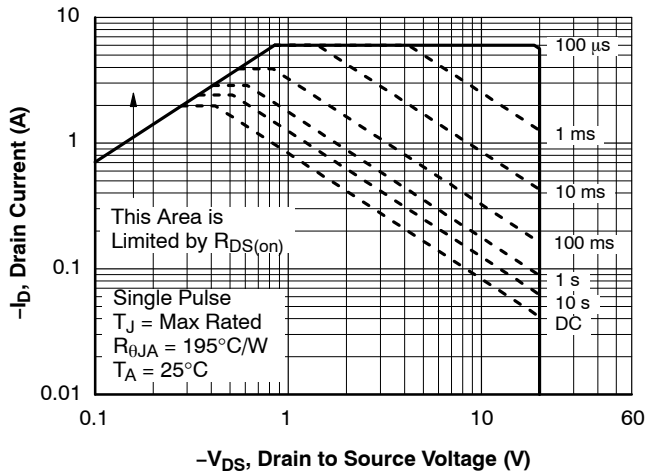

Figure 7. Forward Bias Safe Operating Area

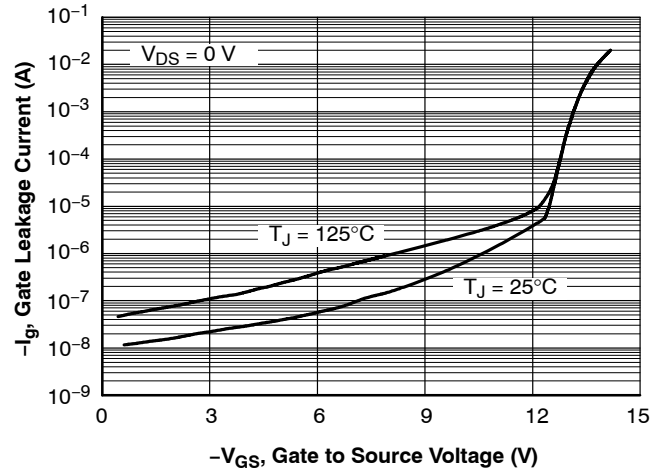

Figure 10. Gate Leakage Current vs. Gate to Source Voltage

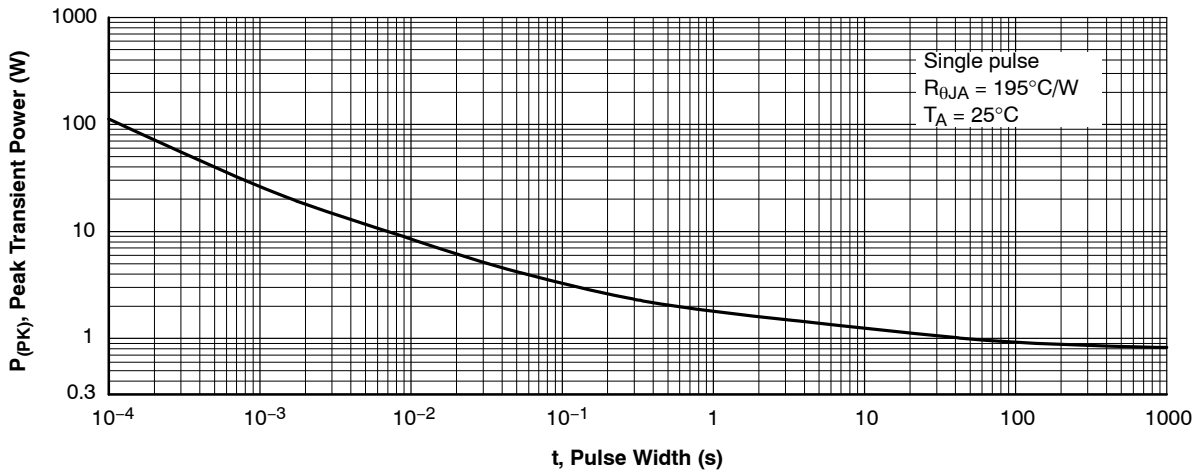

Figure 11. Single Pulse Maximum Power Dissipation

FDME1023PZT

TYPICAL CHARACTERISTICS ($T_J = 25^\circ\text{C}$ unless otherwise noted) (continued)

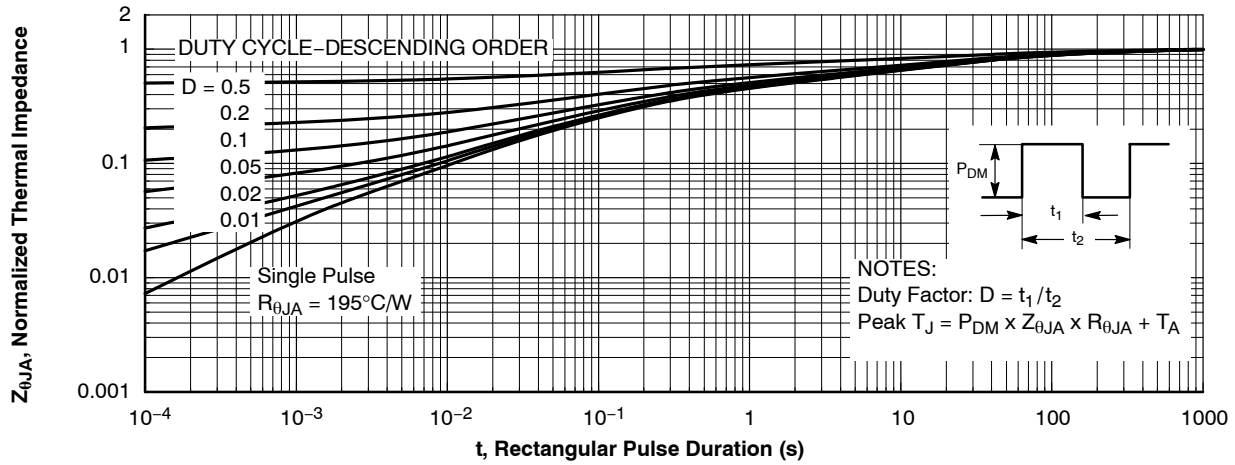

Figure 12. Junction-to-Ambient Transient Thermal Response Curve

PACKAGE MARKING AND ORDERING INFORMATION

Device	Device Marking	Package Type	Reel Size	Tape Width	Shipping [†]
FDME1023PZT	2T	UDFN6 1.6×1.6 0.5P (MicroFET 1.6×1.6 Thin) (Pb-Free/Halide Free)	7"	8 mm	5000 / Tape & Reel

[†]For information on tape and reel specifications, including part orientation and tape sizes, please refer to our Tape and Reel Packaging Specifications Brochure, [BRD8011/D](#).

POWERTRENCH is a registered trademark of Semiconductor Components Industries, LLC dba "onsemi" or its affiliates and/or subsidiaries in the United States and/or other countries.

MicroFET is a trademark of Semiconductor Components Industries, LLC dba "onsemi" or its affiliates and/or subsidiaries in the United States and/or other countries.



UDFN6 1.6x1.6, 0.5P
CASE 517DW
ISSUE O

DATE 31 OCT 2016

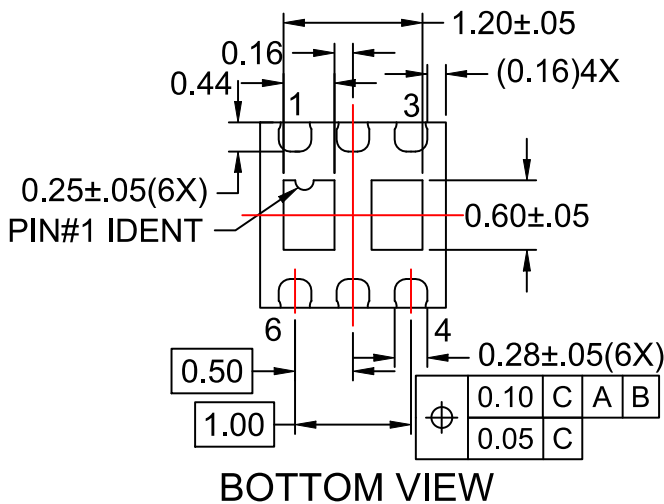
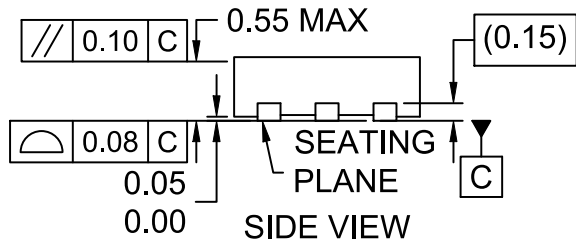
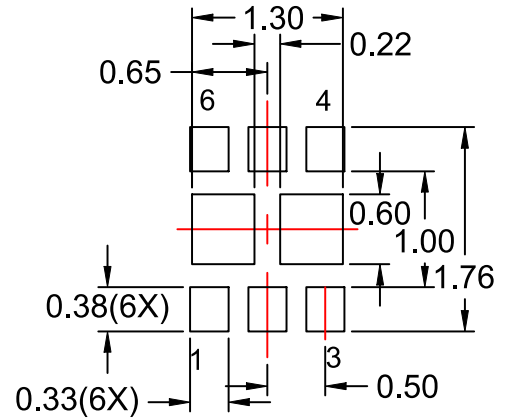
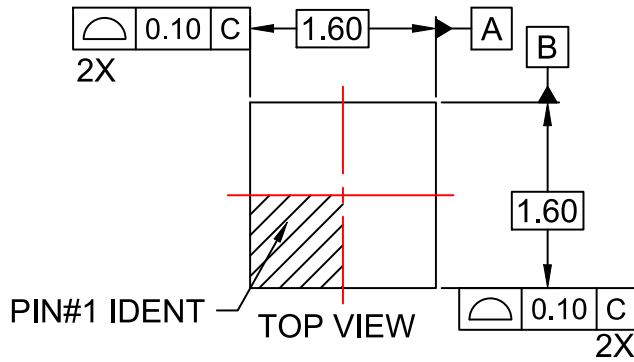

NOTES:

- A. PACKAGE DOES NOT CONFORM TO ANY JEDEC STANDARD.
- B. DIMENSIONS ARE IN MILLIMETERS.
- C. DIMENSIONS AND TOLERANCES PER ASME Y14.5M, 2009.
- D. LAND PATTERN RECOMMENDATION IS EXISTING INDUSTRY LAND PATTERN.

DOCUMENT NUMBER:	98AON13701G	Electronic versions are uncontrolled except when accessed directly from the Document Repository. Printed versions are uncontrolled except when stamped "CONTROLLED COPY" in red.
DESCRIPTION:	UDFN6 1.6x1.6, 0.5P	PAGE 1 OF 1

ON Semiconductor and are trademarks of Semiconductor Components Industries, LLC dba ON Semiconductor or its subsidiaries in the United States and/or other countries. ON Semiconductor reserves the right to make changes without further notice to any products herein. ON Semiconductor makes no warranty, representation or guarantee regarding the suitability of its products for any particular purpose, nor does ON Semiconductor assume any liability arising out of the application or use of any product or circuit, and specifically disclaims any and all liability, including without limitation special, consequential or incidental damages. ON Semiconductor does not convey any license under its patent rights nor the rights of others.

onsemi, **Onsemi**, and other names, marks, and brands are registered and/or common law trademarks of Semiconductor Components Industries, LLC dba "**onsemi**" or its affiliates and/or subsidiaries in the United States and/or other countries. **onsemi** owns the rights to a number of patents, trademarks, copyrights, trade secrets, and other intellectual property. A listing of **onsemi**'s product/patent coverage may be accessed at www.onsemi.com/site/pdf/Patent-Marking.pdf. **onsemi** reserves the right to make changes at any time to any products or information herein, without notice. The information herein is provided "as-is" and **onsemi** makes no warranty, representation or guarantee regarding the accuracy of the information, product features, availability, functionality, or suitability of its products for any particular purpose, nor does **onsemi** assume any liability arising out of the application or use of any product or circuit, and specifically disclaims any and all liability, including without limitation special, consequential or incidental damages. Buyer is responsible for its products and applications using **onsemi** products, including compliance with all laws, regulations and safety requirements or standards, regardless of any support or applications information provided by **onsemi**. "Typical" parameters which may be provided in **onsemi** data sheets and/or specifications can and do vary in different applications and actual performance may vary over time. All operating parameters, including "Typicals" must be validated for each customer application by customer's technical experts. **onsemi** does not convey any license under any of its intellectual property rights nor the rights of others. **onsemi** products are not designed, intended, or authorized for use as a critical component in life support systems or any FDA Class 3 medical devices or medical devices with a same or similar classification in a foreign jurisdiction or any devices intended for implantation in the human body. Should Buyer purchase or use **onsemi** products for any such unintended or unauthorized application, Buyer shall indemnify and hold **onsemi** and its officers, employees, subsidiaries, affiliates, and distributors harmless against all claims, costs, damages, and expenses, and reasonable attorney fees arising out of, directly or indirectly, any claim of personal injury or death associated with such unintended or unauthorized use, even if such claim alleges that **onsemi** was negligent regarding the design or manufacture of the part. **onsemi** is an Equal Opportunity/Affirmative Action Employer. This literature is subject to all applicable copyright laws and is not for resale in any manner.

ADDITIONAL INFORMATION

TECHNICAL PUBLICATIONS:

Technical Library: www.onsemi.com/design/resources/technical-documentation
onsemi Website: www.onsemi.com

ONLINE SUPPORT: www.onsemi.com/support

For additional information, please contact your local Sales Representative at www.onsemi.com/support/sales

