

# MOSFET – N-Channel, POWERTRENCH®

**100 V, 5.6 A, 160 mΩ**

## FDT1600N10ALZ

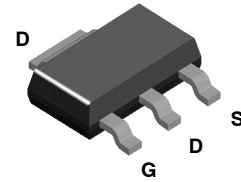

SOT-223  
 CASE 318H

### General Description

This N-Channel MOSFET is produced using onsemi’s advanced POWERTRENCH process that has been tailored to minimize the on-state resistance and maintain superior switching performance.

### Features

- $R_{DS(on)} = 121\text{ m}\Omega$  (Typ.) @  $V_{GS} = 10\text{ V}$ ,  $I_D = 2.8\text{ A}$
- $R_{DS(on)} = 156\text{ m}\Omega$  (Typ.) @  $V_{GS} = 5\text{ V}$ ,  $I_D = 1.8\text{ A}$
- Low Gate Charge (Typ. 2.9 nC)
- Low  $C_{rss}$  (Typ. 2.04 pF)
- Fast Switching
- 100% Avalanche Tested
- Improved dv/dt Capability
- RoHS Compliant

### Applications

- Consumer Appliances
- LED TV and Monitor
- Synchronous Rectification
- Uninterruptible Power Supply
- Micro Solar Inverter

### MARKING DIAGRAM

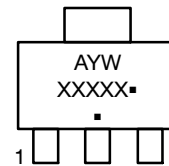

- A = Assembly Location
- Y = Year
- W = Work Week
- X = Specific Device Code
- = Pb-Free Package

(Note: Microdot may be in either location)

### PIN ASSIGNMENT

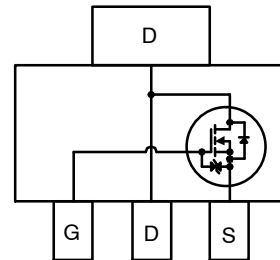

### ORDERING INFORMATION

See detailed ordering and shipping information on page 3 of this data sheet.

# FDT1600N10ALZ

## MOSFET MAXIMUM RATINGS (T<sub>C</sub> = 25°C unless otherwise noted)

Symbol	Parameter		FDT1600N10ALZ	Unit
V <sub>DSS</sub>	Drain to Source Voltage		100	V
V <sub>GSS</sub>	Gate to Source Voltage		±20	V
I <sub>D</sub>	Drain Current	- Continuous (T <sub>C</sub> = 25°C)	5.6	A
		- Continuous (T <sub>C</sub> = 100°C)	3.5	
I <sub>DM</sub>	Drain Current	- Pulsed (Note 2)	11.2	A
E <sub>AS</sub>	Single Pulse Avalanche Energy (Note 3)		9.2	mJ
dv/dt	Peak Diode Recovery dv/dt (Note 4)		6.0	V/ns
P <sub>D</sub>	Power Dissipation	(T <sub>C</sub> = 25°C)	10.42	W
		- Derate Above 25°C	0.083	
T <sub>J</sub> , T <sub>STG</sub>	Operating and Storage Junction Temperature Range		-55 to +150	°C
T <sub>L</sub>	Maximum Lead Temperature for Soldering, 1/8" from Case for 5 Seconds		300	°C

Stresses exceeding those listed in the Maximum Ratings table may damage the device. If any of these limits are exceeded, device functionality should not be assumed, damage may occur and reliability may be affected.

## THERMAL CHARACTERISTICS

Symbol	Parameter		FDT1600N10ALZ	Unit
R <sub>θJC</sub>	Thermal Resistance, Junction to Case (Note 1)		12	°C/W
R <sub>θJA</sub>	Thermal Resistance, Junction to Ambient (Note 1a)		60	

## ELECTRICAL CHARACTERISTICS (T<sub>J</sub> = 25°C unless otherwise noted)

Symbol	Parameter	Test Conditions	Min	Typ	Max	Unit
--------	-----------	-----------------	-----	-----	-----	------

### OFF CHARACTERISTICS

BV <sub>DSS</sub>	Drain to Source Breakdown Voltage	I <sub>D</sub> = 250 μA, V <sub>GS</sub> = 0 V	100	-	-	V
$\frac{\Delta BV_{DSS}}{\Delta T_J}$	Breakdown Voltage Temperature Coefficient	I <sub>D</sub> = 250 μA, Referenced to 25°C	-	0.1	-	V/°C
I <sub>DSS</sub>	Zero Gate Voltage Drain Current	V <sub>DS</sub> = 80 V, V <sub>GS</sub> = 0 V	-	-	1	μA
		V <sub>DS</sub> = 80 V, V <sub>GS</sub> = 0 V, T <sub>C</sub> = 125°C	-	-	500	
I <sub>GSS</sub>	Gate to Source Leakage Current	V <sub>GS</sub> = ±20 V, V <sub>DS</sub> = 0 V	-	-	±10	μA

### ON CHARACTERISTICS

V <sub>GS(th)</sub>	Gate to Source Threshold Voltage	V <sub>GS</sub> = V <sub>DS</sub> , I <sub>D</sub> = 250 μA	1.4	-	2.8	V
R <sub>DS(on)</sub>	Static Drain to Source On Resistance	V <sub>GS</sub> = 10 V, I <sub>D</sub> = 2.8 A	-	121	160	mΩ
		V <sub>GS</sub> = 5 V, I <sub>D</sub> = 1.8 A	-	156	375	
g <sub>FS</sub>	Forward Transconductance	V <sub>DS</sub> = 10 V, I <sub>D</sub> = 5.6 A	-	26.1	-	S

### DYNAMIC CHARACTERISTICS

C <sub>iss</sub>	Input Capacitance	V <sub>DS</sub> = 50 V, V <sub>GS</sub> = 0 V, f = 1 MHz	-	169	225	pF	
C <sub>oss</sub>	Output Capacitance		-	43	55	pF	
C <sub>rss</sub>	Reverse Transfer Capacitance		-	2.04	-	pF	
C <sub>oss(er)</sub>	Energy Related Output Capacitance	V <sub>DS</sub> = 50 V, V <sub>GS</sub> = 0 V	-	85	-	pF	
Q <sub>g(tot)</sub>	Total Gate Charge at 10 V	V <sub>GS</sub> = 10 V	V <sub>DD</sub> = 50 V, I <sub>D</sub> = 5.6 A  (Note 5)	-	2.9	3.77	nC
Q <sub>g(tot)</sub>	Total Gate Charge at 5 V	V <sub>GS</sub> = 5 V		-	1.6	2.08	
Q <sub>gs</sub>	Gate to Source Gate Charge			-	0.7	-	
Q <sub>gd</sub>	Gate to Drain "Miller" Charge			-	0.64	-	
V <sub>plateau</sub>	Gate Plateau Voltage			-	3.81	-	
Q <sub>sync</sub>	Total Gate Charge Sync.	V <sub>DS</sub> = 0 V, I <sub>D</sub> = 2.8 A	-	2.45	-	nC	
Q <sub>oss</sub>	Output Charge	V <sub>DS</sub> = 50 V, V <sub>GS</sub> = 0 V	-	5.2	-	nC	

# FDT1600N10ALZ

## ELECTRICAL CHARACTERISTICS ( $T_J = 25^\circ\text{C}$ unless otherwise noted) (continued)

Symbol	Parameter	Test Conditions	Min	Typ	Max	Unit
ESR	Equivalent Series Resistance (G-S)	$f = 1 \text{ MHz}$	-	2.1	-	$\Omega$

## SWITCHING CHARACTERISTICS

Symbol	Parameter	Test Conditions	Min	Typ	Max	Unit
$t_{d(on)}$	Turn-On Delay Time	$V_{DD} = 50 \text{ V}$ , $I_D = 5.6 \text{ A}$ , $V_{GS} = 10 \text{ V}$ , $R_G = 4.7 \Omega$	-	7.4	24.8	ns
$t_r$	Rise Time		-	2.5	15	ns
$t_{d(off)}$	Turn-Off Delay Time		-	13.5	37	ns
$t_f$	Turn-Off Fall Time		-	2.4	14.8	ns

(Note 5)

## DRAIN-SOURCE DIODE CHARACTERISTICS

Symbol	Parameter	Test Conditions	Min	Typ	Max	Unit
$I_S$	Maximum Continuous Drain to Source Diode Forward Current		-	-	5.6	A
$I_{SM}$	Maximum Pulsed Drain to Source Diode Forward Current		-	-	11.2	A
$V_{SD}$	Source to Drain Diode Forward Voltage	$V_{GS} = 0 \text{ V}$ , $I_S = 5.6 \text{ A}$	-	-	1.3	V
$t_{rr}$	Reverse Recovery Time	$V_{GS} = 0 \text{ V}$ , $I_{SD} = 5.6 \text{ A}$ , $V_{DD} = 50 \text{ V}$ $di_f/dt = 100 \text{ A}/\mu\text{s}$	-	34.1	-	ns
$Q_{rr}$	Reverse Recovery Charge		-	32.7	-	nC

Product parametric performance is indicated in the Electrical Characteristics for the listed test conditions, unless otherwise noted. Product performance may not be indicated by the Electrical Characteristics if operated under different conditions.

- $R_{\theta JA}$  is the sum of the junction-to-case and case-to-ambient thermal resistance where the case thermal reference is defined as the solder mounting surface of the drain pins.  $R_{\theta JC}$  is guaranteed by design while  $R_{\theta CA}$  is determined by the user's board design.

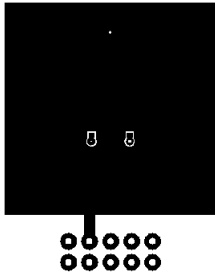

a.  $60^\circ\text{C}/\text{W}$  when mounted on a 1 in<sup>2</sup> pad of 2 oz copper

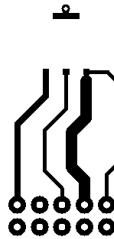

b.  $118^\circ\text{C}/\text{W}$  when mounted on a minimum pad of 2 oz copper

- Repetitive rating: pulse-width limited by maximum junction temperature.
- Starting  $T_J = 25^\circ\text{C}$ ,  $L = 3 \text{ mH}$ ,  $I_{AS} = 2.47 \text{ A}$ .
- $I_{SD} \leq 5.6 \text{ A}$ ,  $di/dt \leq 200 \text{ A}/\mu\text{s}$ ,  $V_{DD} \leq BV_{DSS}$ , starting  $T_J = 25^\circ\text{C}$ .
- Essentially independent of operating temperature typical characteristics.

## PACKAGE MARKING AND ORDERING INFORMATION

Part Number	Top Mark	Package	Reel Size	Tape Width	Shipping†
FDT1600N10ALZ	16010ALZ	SOT-223	13"	12 mm	4000/ Tape & Reel

†For information on tape and reel specifications, including part orientation and tape sizes, please refer to our Tape and Reel Packaging Specifications Brochure, [BRD8011/D](#).

# FDT1600N10ALZ

## TYPICAL CHARACTERISTICS

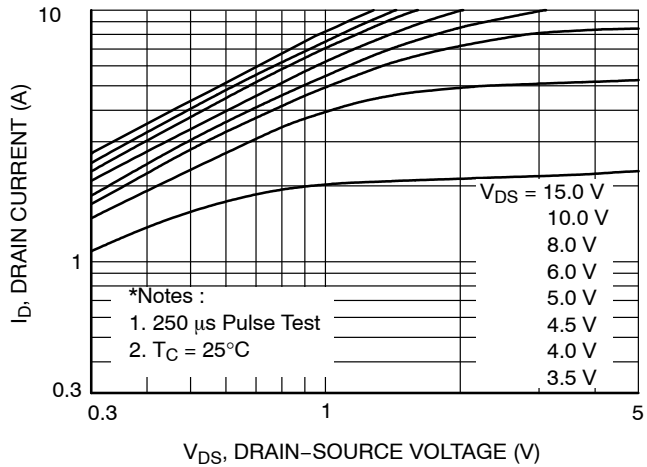

Figure 1. On-Region Characteristics

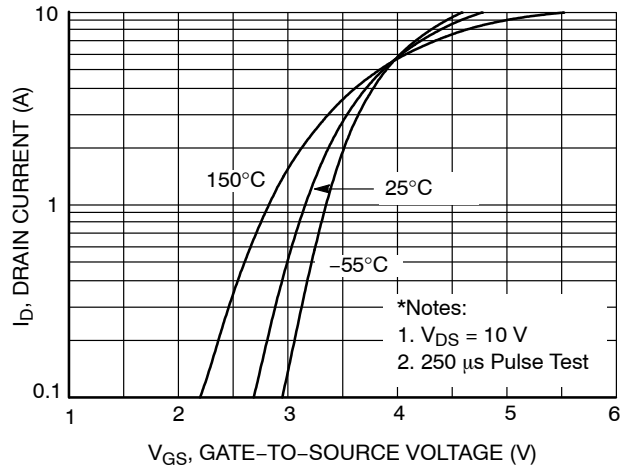

Figure 2. Transfer Characteristics

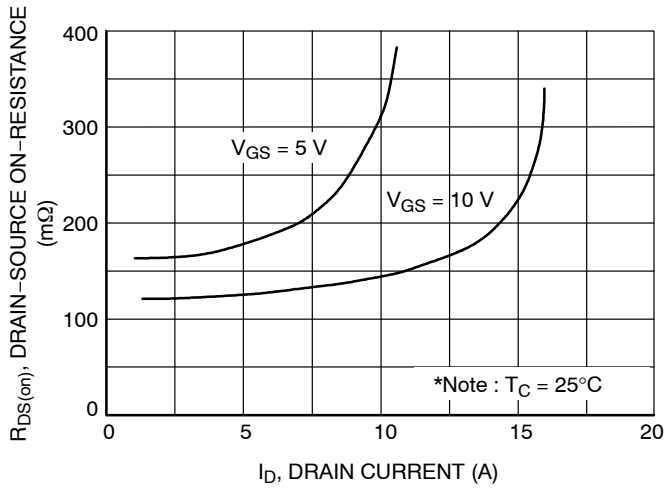

Figure 3. On-Resistance Variation vs. Drain Current and Gate Voltage

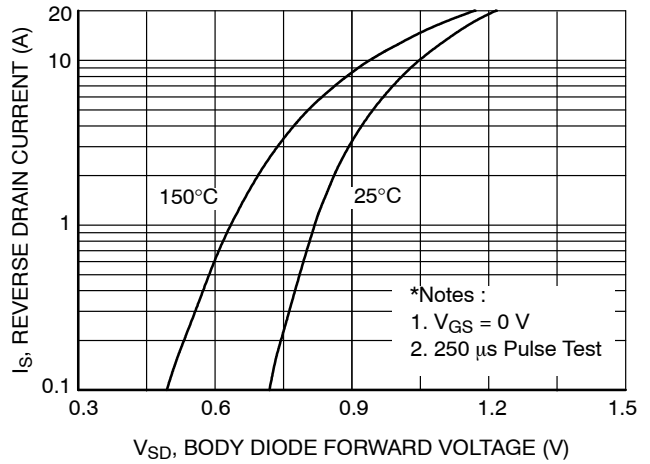

Figure 4. Body Diode Forward Voltage Variation vs. Source Current and Temperature

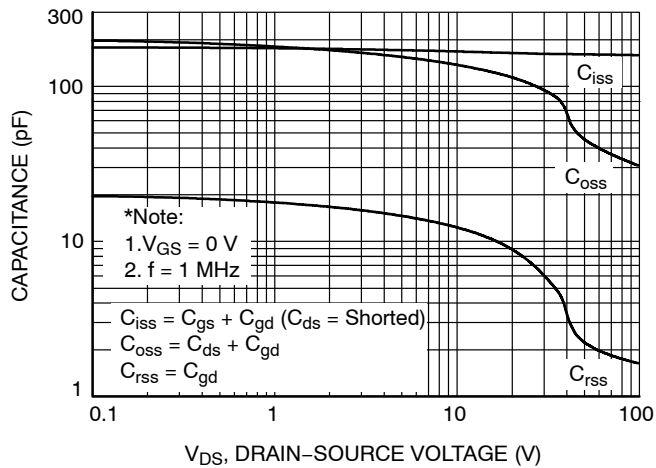

Figure 5. Capacitance Characteristics

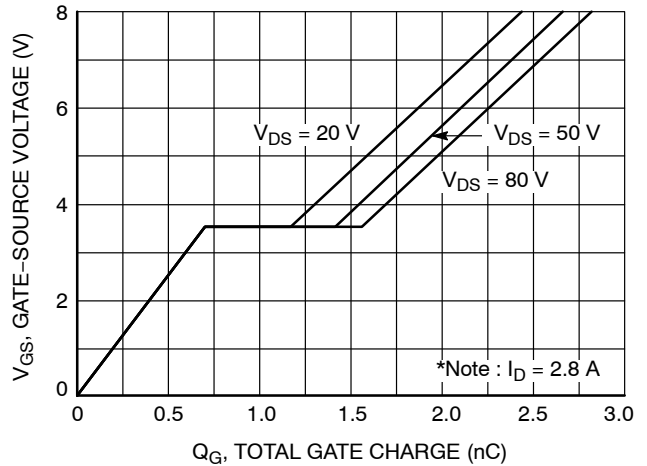
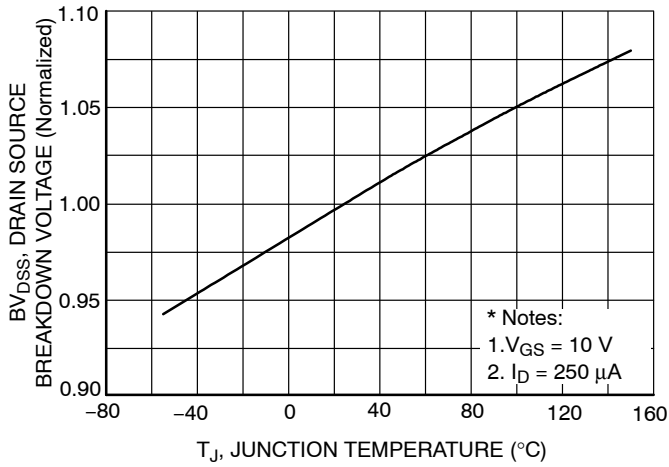

Figure 6. Gate Charge Characteristics

# FDT1600N10ALZ

## TYPICAL CHARACTERISTICS (continued)



**Figure 7. Breakdown Voltage Variation vs. Temperature**

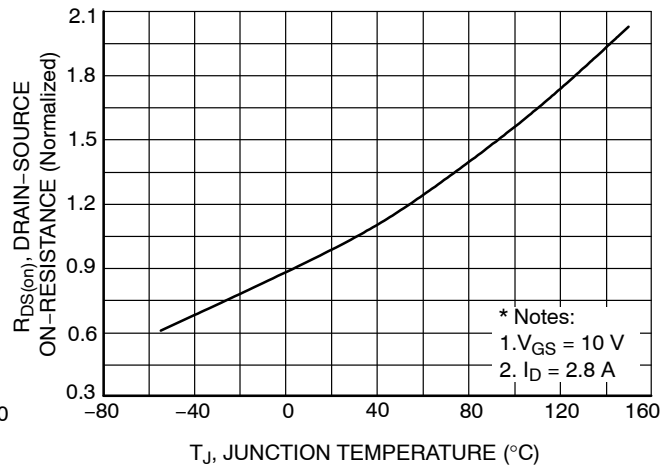

**Figure 8. On-Resistance Variation vs. Temperature**

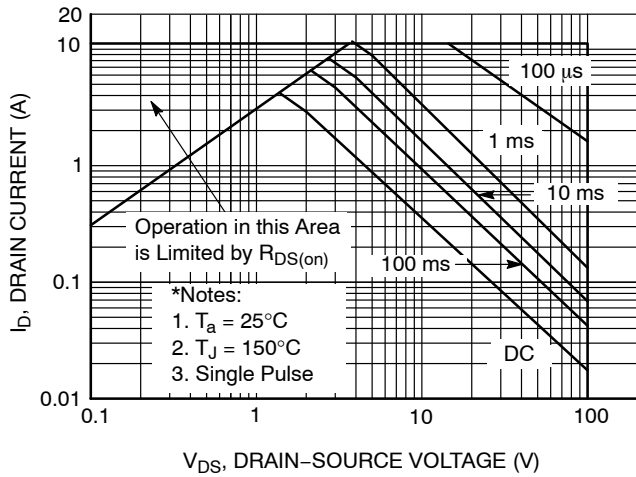

**Figure 9. Maximum Safe Operating Area**

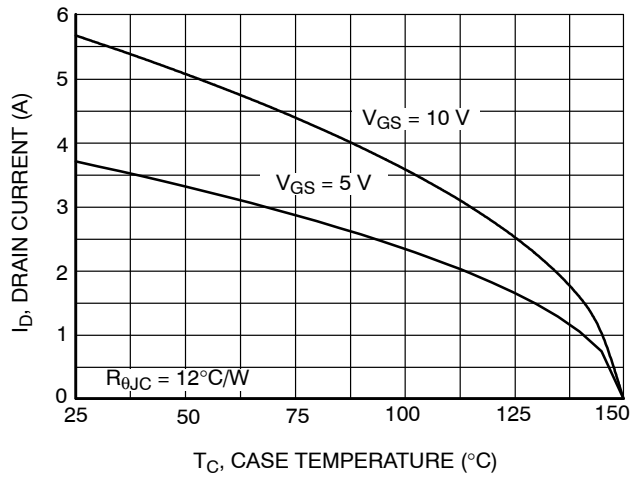

**Figure 10. Maximum Drain Current vs. Case Temperature**

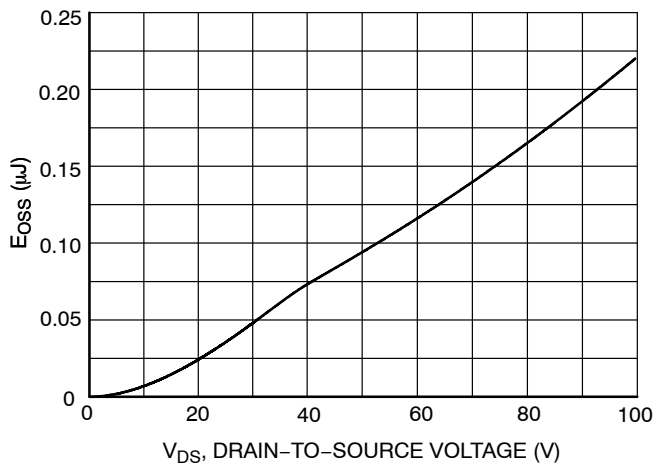

**Figure 11.  $E_{OSS}$  vs. Drain-to-Source Voltage**

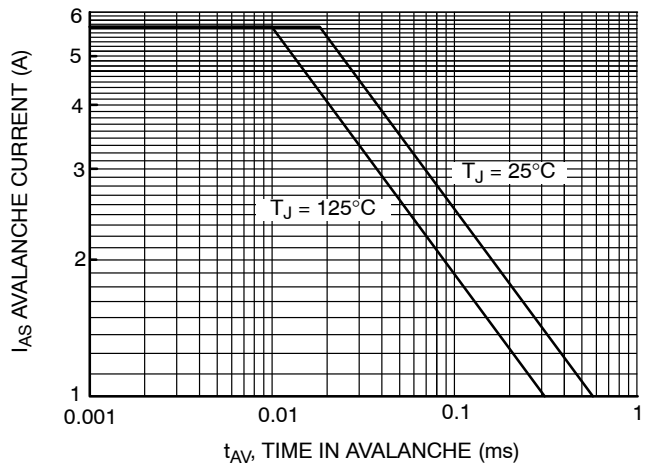

**Figure 12. Unclamped Inductive Switching Capability**

# FDT1600N10ALZ

## TYPICAL CHARACTERISTICS (continued)

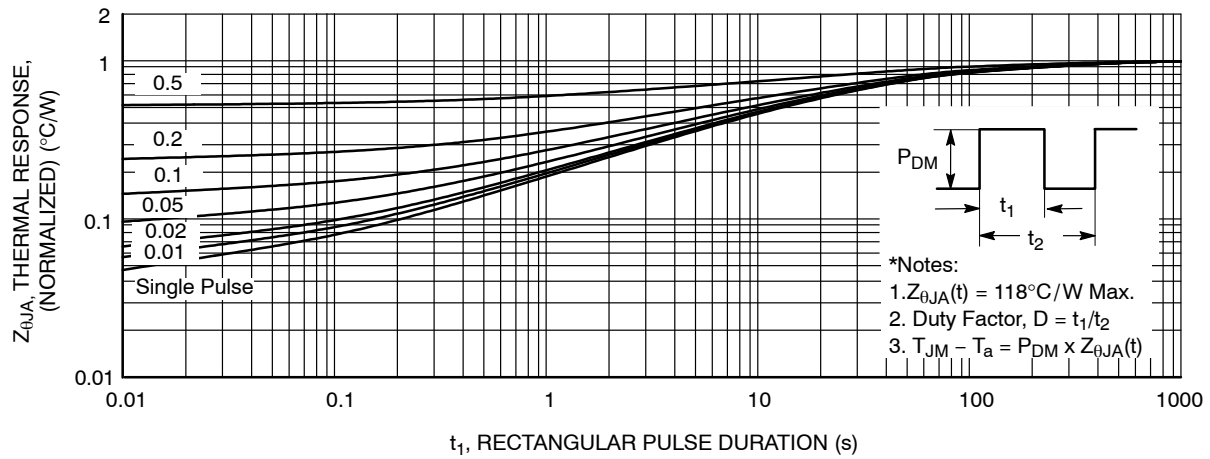

Figure 13. Transient Thermal Response Curve

# FDT1600N10ALZ

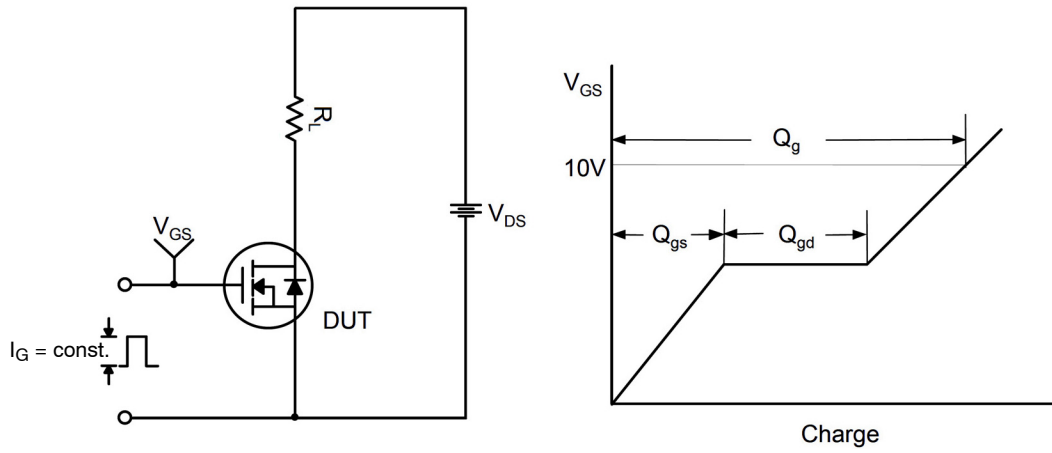

Figure 14. Gate Charge Test Circuit & Waveform

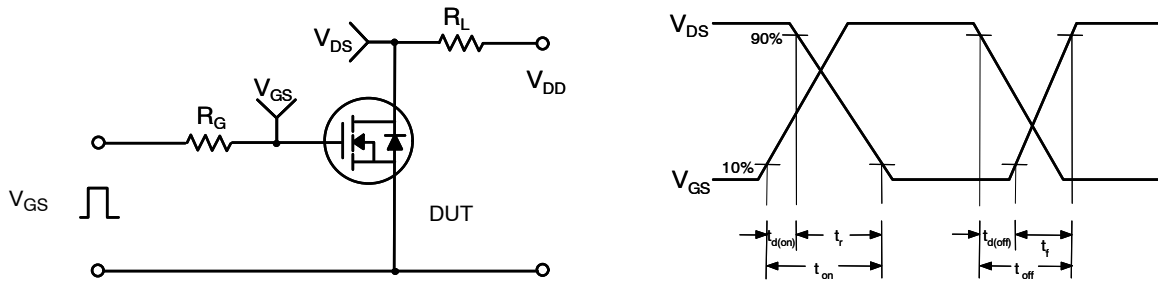

Figure 15. Resistive Switching Test Circuit & Waveforms

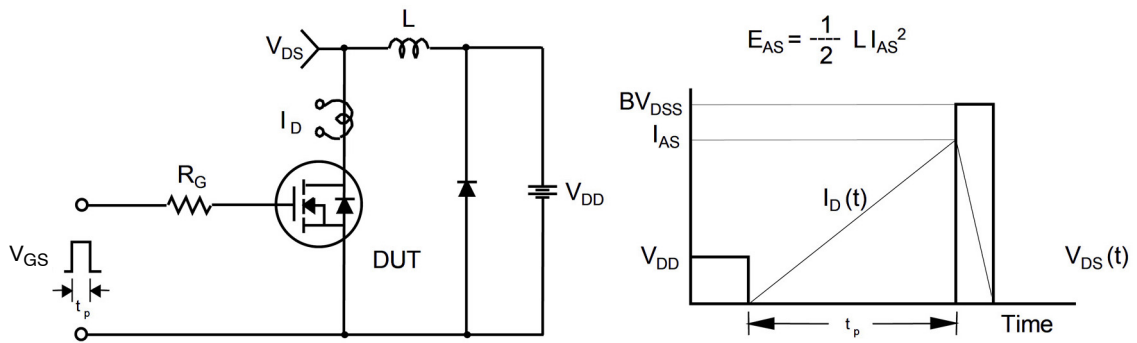

Figure 16. Unclamped Inductive Switching Test Circuit & Waveforms

# FDT1600N10ALZ

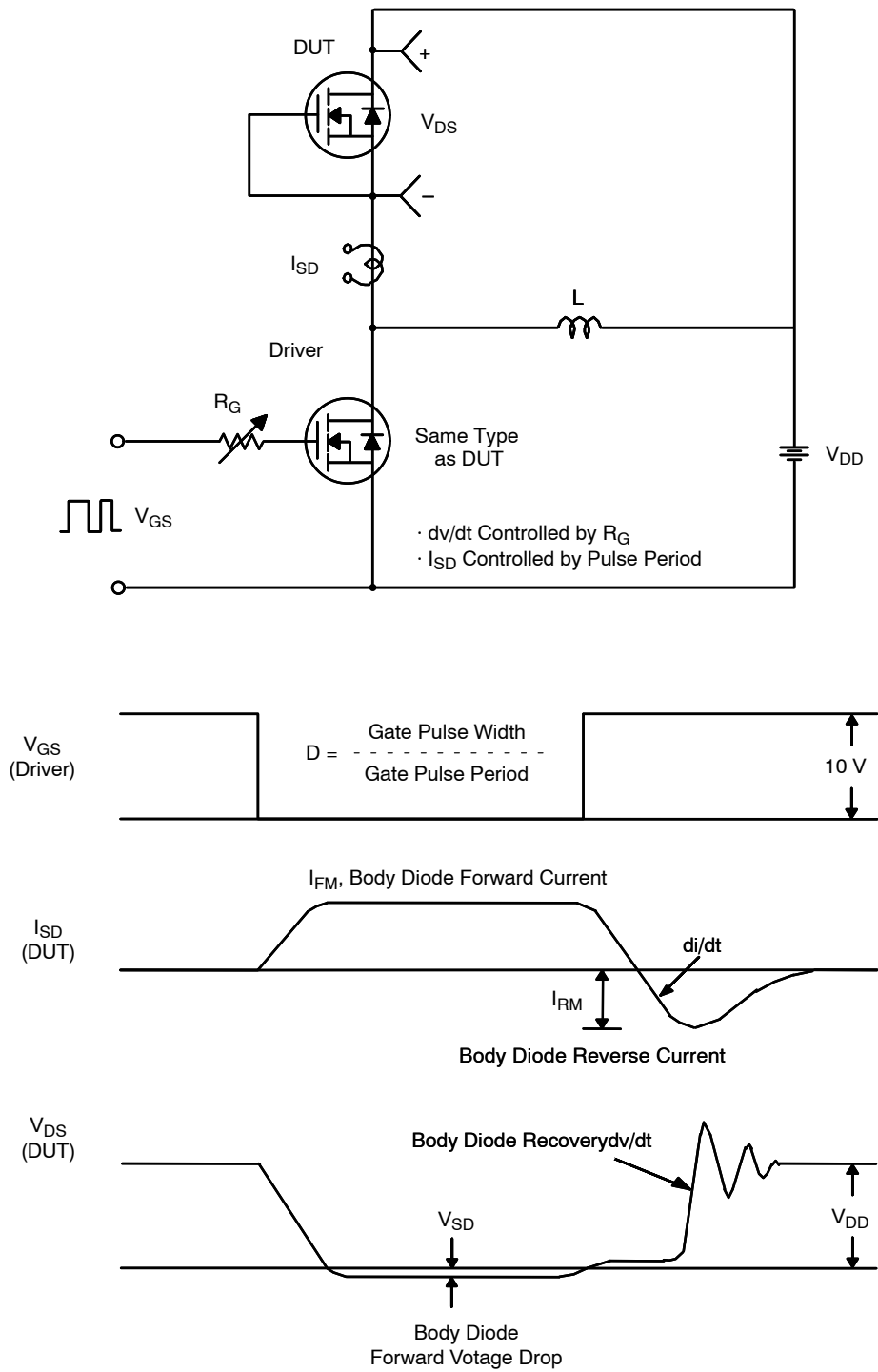

Figure 17. Peak Diode Recovery  $dv/dt$  Test Circuit & Waveforms



# FDT1600N10ALZ

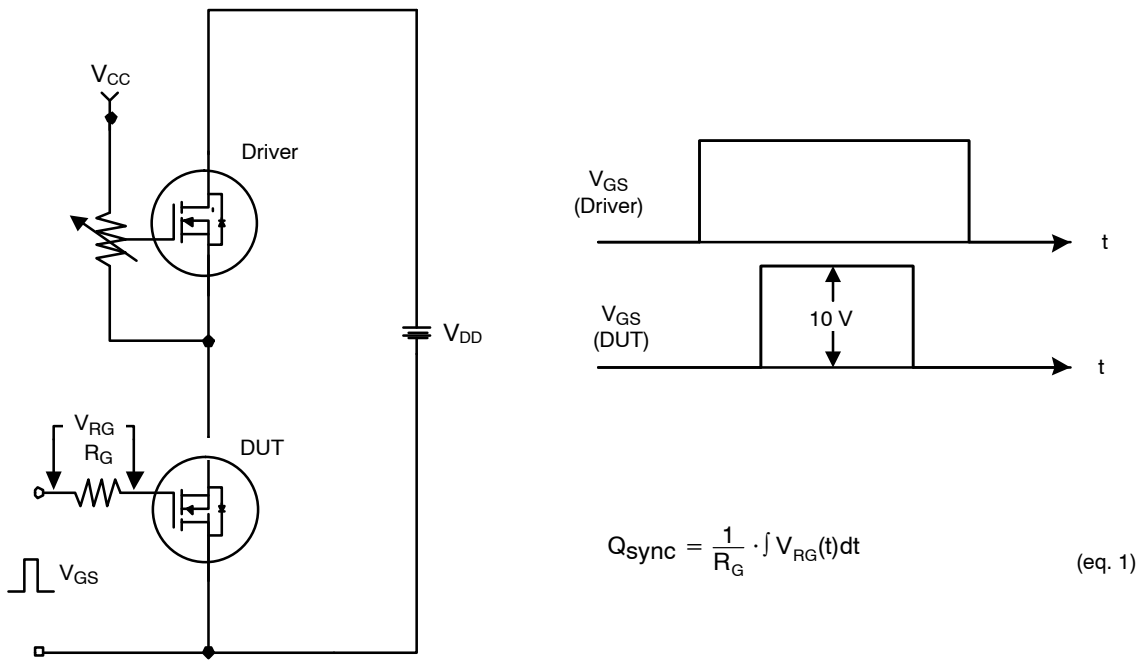
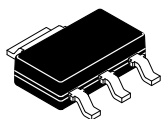

Figure 18. Total Gate Charge  $Q_{sync}$ . Test Circuit & Waveforms

# MECHANICAL CASE OUTLINE

## PACKAGE DIMENSIONS

ON Semiconductor®



**SOT-223**  
CASE 318H  
ISSUE B

DATE 13 MAY 2020

SCALE 2:1

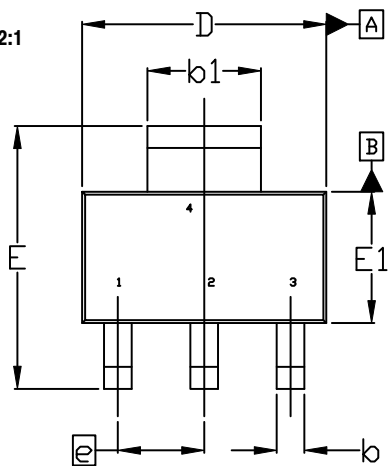

TOP VIEW

$\text{Ø} 0.10 \text{ (M) C A B}$

NOTE 7

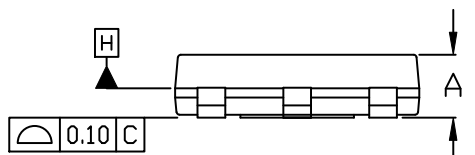

SIDE VIEW

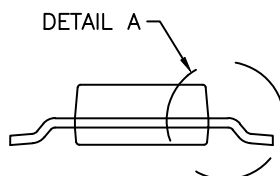

END VIEW

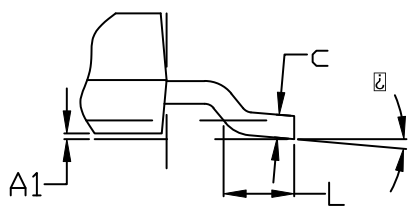

DETAIL A

**NOTES:**

1. DIMENSIONING AND TOLERANCING PER ASME Y14.5M, 2009.
2. CONTROLLING DIMENSION: MILLIMETERS
3. DIMENSIONS D & E1 ARE DETERMINED AT DATUM H. DIMENSIONS DO NOT INCLUDE MOLD FLASH, PROTRUSIONS OR GATE BURRS. SHALL NOT EXCEED 0.23mm PER SIDE.
4. LEAD DIMENSIONS b AND b1 DO NOT INCLUDE DAMBAR PROTRUSION. ALLOWABLE DAMBAR PROTRUSION IS 0.08mm PER SIDE.
5. DATUMS A AND B ARE DETERMINED AT DATUM H.
6. A1 IS DEFINED AS THE VERTICAL DISTANCE FROM THE SEATING PLANE TO THE LOWEST POINT OF THE PACKAGE BODY.
7. POSITIONAL TOLERANCE APPLIES TO DIMENSIONS b AND b1.

DIM	MILLIMETERS		
	MIN.	NDM.	MAX.
A	---	---	1.80
A1	0.02	0.06	0.11
b	0.60	0.74	0.88
b1	2.90	3.00	3.10
c	0.24	---	0.35
D	6.30	6.50	6.70
E	6.70	7.00	7.30
E1	3.30	3.50	3.70
e	2.30 BSC		
L	0.25	---	---
$\text{Ø}$	0°	---	10°

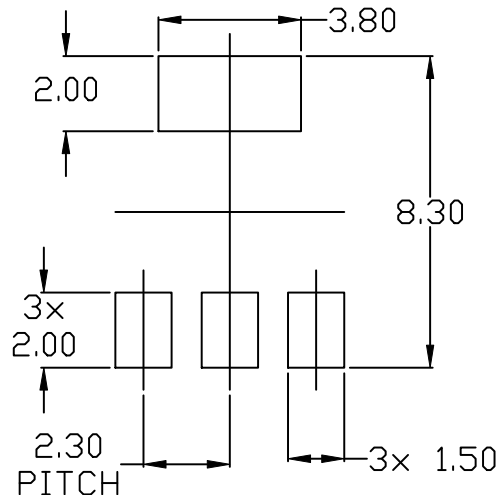

RECOMMENDED MOUNTING FOOTPRINT

\* For additional information on our Pb-Free strategy and soldering details, please download the ON Semiconductor Soldering and Mounting Techniques Reference Manual, SOLDERM/D.

**GENERIC MARKING DIAGRAM\***

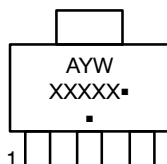

- A = Assembly Location
- Y = Year
- W = Work Week
- XXXXX = Specific Device Code
- = Pb-Free Package

(Note: Microdot may be in either location)

\*This information is generic. Please refer to device data sheet for actual part marking. Pb-Free indicator, "G" or microdot "▪", may or may not be present. Some products may not follow the Generic Marking.

<b>DOCUMENT NUMBER:</b>	<b>98ASH70634A</b>	Electronic versions are uncontrolled except when accessed directly from the Document Repository. Printed versions are uncontrolled except when stamped "CONTROLLED COPY" in red.
<b>DESCRIPTION:</b>	<b>SOT-223</b>	<b>PAGE 1 OF 1</b>

ON Semiconductor and are trademarks of Semiconductor Components Industries, LLC dba ON Semiconductor or its subsidiaries in the United States and/or other countries. ON Semiconductor reserves the right to make changes without further notice to any products herein. ON Semiconductor makes no warranty, representation or guarantee regarding the suitability of its products for any particular purpose, nor does ON Semiconductor assume any liability arising out of the application or use of any product or circuit, and specifically disclaims any and all liability, including without limitation special, consequential or incidental damages. ON Semiconductor does not convey any license under its patent rights nor the rights of others.

**onsemi**, **Onsemi**, and other names, marks, and brands are registered and/or common law trademarks of Semiconductor Components Industries, LLC dba "**onsemi**" or its affiliates and/or subsidiaries in the United States and/or other countries. **onsemi** owns the rights to a number of patents, trademarks, copyrights, trade secrets, and other intellectual property. A listing of **onsemi**'s product/patent coverage may be accessed at [www.onsemi.com/site/pdf/Patent-Marking.pdf](http://www.onsemi.com/site/pdf/Patent-Marking.pdf). **onsemi** reserves the right to make changes at any time to any products or information herein, without notice. The information herein is provided "as-is" and **onsemi** makes no warranty, representation or guarantee regarding the accuracy of the information, product features, availability, functionality, or suitability of its products for any particular purpose, nor does **onsemi** assume any liability arising out of the application or use of any product or circuit, and specifically disclaims any and all liability, including without limitation special, consequential or incidental damages. Buyer is responsible for its products and applications using **onsemi** products, including compliance with all laws, regulations and safety requirements or standards, regardless of any support or applications information provided by **onsemi**. "Typical" parameters which may be provided in **onsemi** data sheets and/or specifications can and do vary in different applications and actual performance may vary over time. All operating parameters, including "Typicals" must be validated for each customer application by customer's technical experts. **onsemi** does not convey any license under any of its intellectual property rights nor the rights of others. **onsemi** products are not designed, intended, or authorized for use as a critical component in life support systems or any FDA Class 3 medical devices or medical devices with a same or similar classification in a foreign jurisdiction or any devices intended for implantation in the human body. Should Buyer purchase or use **onsemi** products for any such unintended or unauthorized application, Buyer shall indemnify and hold **onsemi** and its officers, employees, subsidiaries, affiliates, and distributors harmless against all claims, costs, damages, and expenses, and reasonable attorney fees arising out of, directly or indirectly, any claim of personal injury or death associated with such unintended or unauthorized use, even if such claim alleges that **onsemi** was negligent regarding the design or manufacture of the part. **onsemi** is an Equal Opportunity/Affirmative Action Employer. This literature is subject to all applicable copyright laws and is not for resale in any manner.

## ADDITIONAL INFORMATION

### TECHNICAL PUBLICATIONS:

Technical Library: [www.onsemi.com/design/resources/technical-documentation](http://www.onsemi.com/design/resources/technical-documentation)  
onsemi Website: [www.onsemi.com](http://www.onsemi.com)

### ONLINE SUPPORT: [www.onsemi.com/support](http://www.onsemi.com/support)

For additional information, please contact your local Sales Representative at [www.onsemi.com/support/sales](http://www.onsemi.com/support/sales)

