

Product Document

AS3729

5A Power Stage

General Description

The AS3729 is a companion power stage, intended to be used with AS372x products. It cannot be used without a DCDC controller. It contains the power FETs for 2 phases and is capable to handle output currents of 2.5A per phase.

Ordering Information and Content Guide appear at end of datasheet.

Key Benefits & Features

The benefits and features of AS3729, 5A Power Stage are listed below:

Figure 1:
Added Value of Using AS3729

Benefits	Features
Support for single or dual phase operation	<ul style="list-style-type: none"> • 2 phases with separate control input
2 x 2.5A output stages are running on 3MHz	<ul style="list-style-type: none"> • Separate power NMOS & PMOS for 2.5A per phase • Separate coil current feedback per phase • Stand-alone zero-crossing operation
Over-temperature protection	<ul style="list-style-type: none"> • Integrated temperature monitoring
Cost effective, small package	<ul style="list-style-type: none"> • 16-pin WL-CSP: 1.615mm x 1.615mm, 0.4mm pitch

Applications

The device is a high current dual-phase DCDC and ideal for:

- Mobile phones
- Tablets
- Notebooks

Block Diagram

The functional blocks of this device for reference are shown below:

Figure 2:
AS3729 Block Diagram

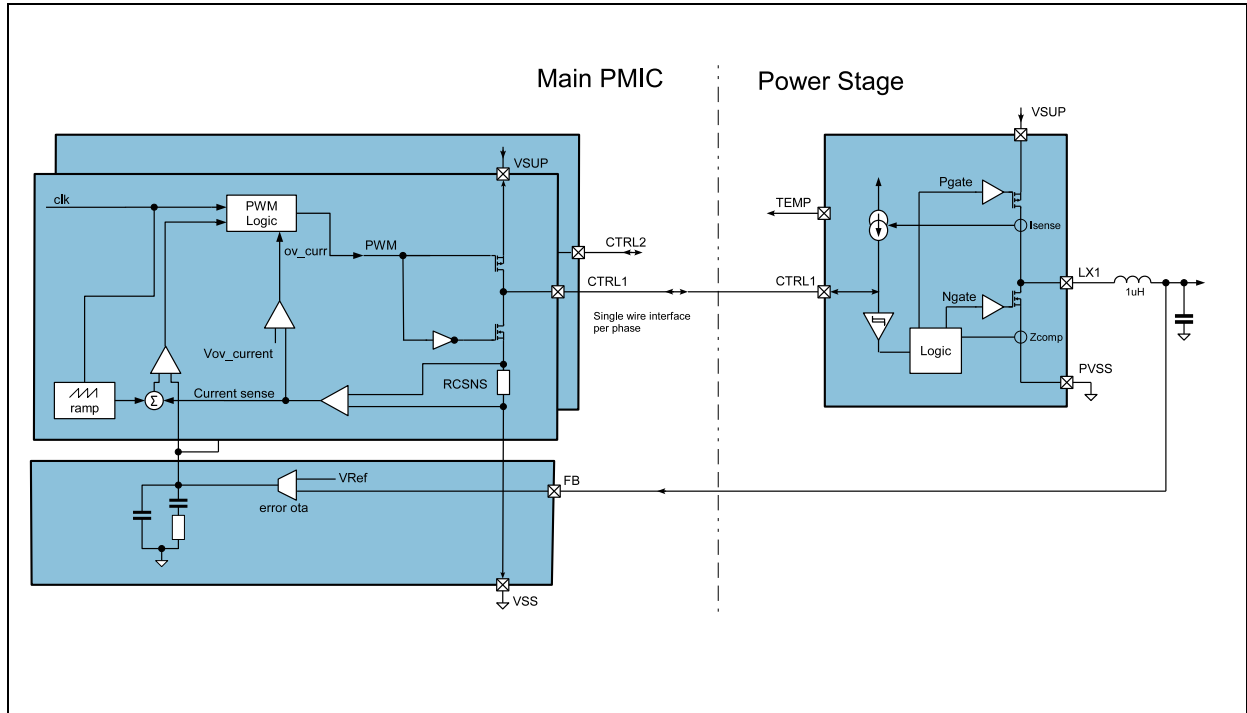

AS3729 Block Diagram: This figure shows the block diagram of the DCDC controller inside the Main PMIC and the AS3729 Power Stage with all relevant system components.

Pin Assignment

Figure 3:
Pin Diagram

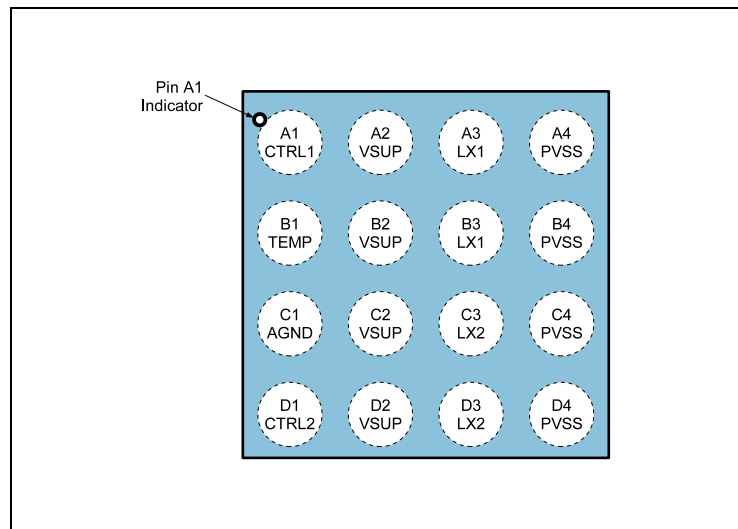

Figure 4:
Pin Description

Pin Number	Pin Name	Description
A1	CTRL1	Control IO for phase 1
B1	TEMP	ON/OFF control and temperature feedback
C1	AGND	Analog ground
D1	CTRL2	Control IO for phase 2
A2, B2	VSUP	Phase 1 positive supply terminal
C2, D2	VSUP	Phase 2 positive supply terminal
A3, B3	LX1	Phase 1 switching output to coil
C3, D3	LX2	Phase 2 switching output to coil
A4, B4	PVSS	Phase 1 negative supply terminal
C4, D4	PVSS	Phase 2 negative supply terminal

Absolute Maximum Ratings

Stresses beyond those listed under [Absolute Maximum Ratings](#) may cause permanent damage to the device. These are stress ratings only. Functional operation of the device at these or any other conditions beyond those indicated under [Electrical Characteristics](#) is not implied. Exposure to absolute maximum rating conditions for extended periods may affect device reliability.

Figure 5:
Absolute Maximum Ratings

Symbol	Parameter	Min	Max	Units	Comments
Electrical Parameters					
	Supply voltage to ground 5V pins	-0.5	7.0	V	Applicable for pins VSUPx, LXx, CTRLx
	Supply voltage to ground 3V pins	-0.5	5.0	V	Applicable for pin TEMP
	Voltage difference between ground terminals	-0.5	0.5	V	Applicable for pins PVSS, AGND
	Input current (latch-up immunity)	-100	100	mA	Norm: JEDEC JESD78
Continuous Power Dissipation (T_A = 70°C)					
P _T	Continuous power dissipation		1	W	P _T ⁽¹⁾ for WL-CSP16 package (R _{THJA} ~ 55K/W)
Electrostatic Discharge					
ESD	Electrostatic discharge HBM	±1.5		kV	Norm: JEDEC JESD22-A114F
Temperature Ranges and Storage Conditions					
T _A	Operating temperature	-40	85	°C	
R _{THJA}	Junction to ambient thermal resistance			°C/W	R _{THJA} typical 55K/W
T _J	Junction temperature		125	°C	
T _{Strg}	Storage temperature range	-55	125	°C	
T _{BODY}	Package body temperature		260	°C	Norm IPC/JEDEC J-STD-020 ⁽²⁾
RH _{NC}	Relative humidity (non-condensing)	5	85	%	
MSL	Moisture sensitivity level	1			Represents an unlimited floor life time

Note(s) and/or Footnote(s):

- Depending on actual PCB layout and PCB used.
- The reflow peak soldering temperature (body temperature) is specified according IPC/JEDEC J-STD-020 "Moisture/Reflow Sensitivity Classification for Nonhermetic Solid State Surface Mount Devices".

Electrical Characteristics

Typical values are at $V_{SUP} = 3.8V$, $T_A = 25^\circ C$ (unless otherwise specified). All limits are guaranteed. The parameters with Min and Max values are guaranteed with production tests or SQC (Statistical Quality Control) methods.

Figure 6:
Step Down DCDC Power Stage Parameters

Symbol	Parameter	Comments	Min	Typ	Max	Units
V_{IN}	Input voltage	Pin VSUPx	2.5		5.5	V
		Pin CTRLx	0		5.5	V
		Pin TEMP	0		3.6	V
I_{LIMIT}	Peak coil current limit	Single phase			4	A
I_{LOAD}	Load current	Continuous load current	0		2.5	A
		Peak load current			3 ⁽¹⁾	
R_{PMOS}	P-switch On resistance ⁽²⁾	Single phase		40	70	m Ω
R_{NMOS}	N-switch On resistance ⁽²⁾	Single phase		30	50	m Ω
f_{SW}	Switching frequency	Supplied by DCDC controller		2.7	3	MHz
$I_{Q_force_PWM}$	Quiescent current PWM	TEMP pin high, force PWM mode active		6.2		mA
$I_{Q_low_power}$	Quiescent current LP	TEMP pin high, low power mode active		21		μA
I_{power_off}	Power-Off current	No current into pin TEMP		± 1		μA
$R_{discharge}$	active discharge	Single phase		16		Ω

Note(s) and/or Footnote(s):

1. Maximum value only for pulsed peak current.
2. MOS transistor only without package parasitics.

Figure 7:
Step Down DCDC Power Stage External Components

Symbol	Parameter	Min	Typ	Max	Units	Note
External Components Per Phase						
C_{FB}	Output capacitor	40	47		μF	Ceramic X5R or X7R, high performance
		20	22		μF	Ceramic X5R or X7R, cost optimized
C_{VSUP}	Input capacitor	6	10		μF	Ceramic X5R or X7R
L	Inductor	0.3	0.47		μH	3A rated, 3MHz operation, low R_{ON}

Parameters

Figure 8:
3.7V Efficiency vs. Output Current Combined Mode

AS3729 Step Down DCDC: Shows the Efficiency of AS3729 with $V_{SUP} = 3.7V$, 1.5MHz operation, $T_A = 25^\circ C$ and Coilcraft XAL5030-601MEB coil

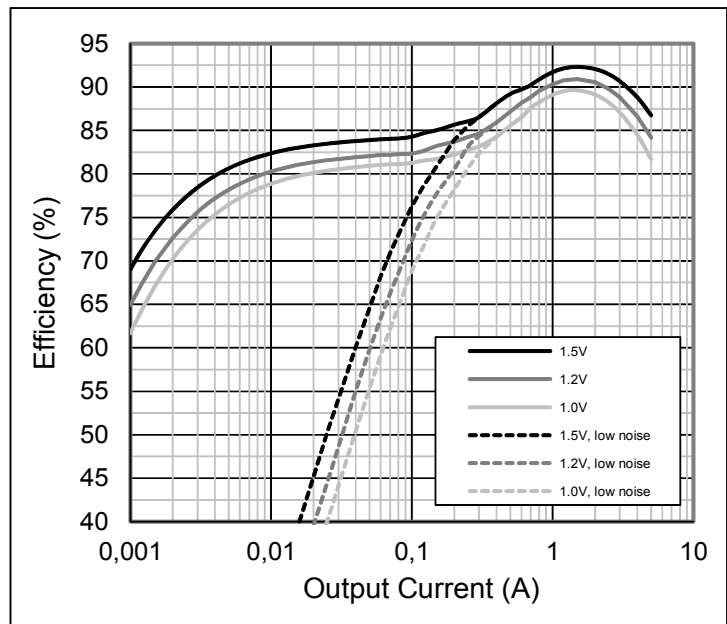

Figure 9:
3.7V Efficiency vs. Output Current Coil Comparison

AS3729 Step Down DCDC: Shows the Efficiency of the AS3729 for different coils @ 1.0V with VSUP=3.7V, 1.5MHz operation and $T_A=25^\circ\text{C}$.

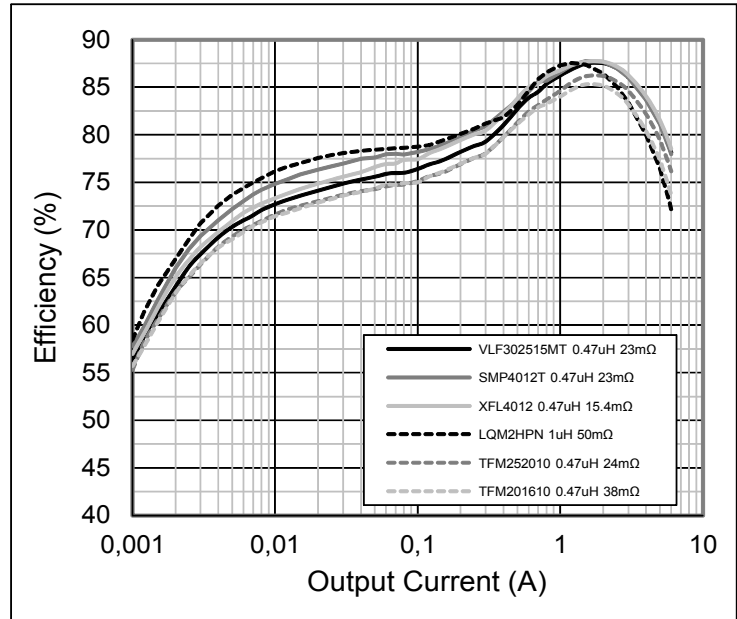

Figure 10:
3.7V Efficiency vs. Output Current Coil Comparison Combined Mode

AS3729 Step Down DCDC: Shows the Efficiency of the AS3729 for different coils @ 1.0V with VSUP=3.7V, 1.5MHz operation and $T_A=25^\circ\text{C}$.

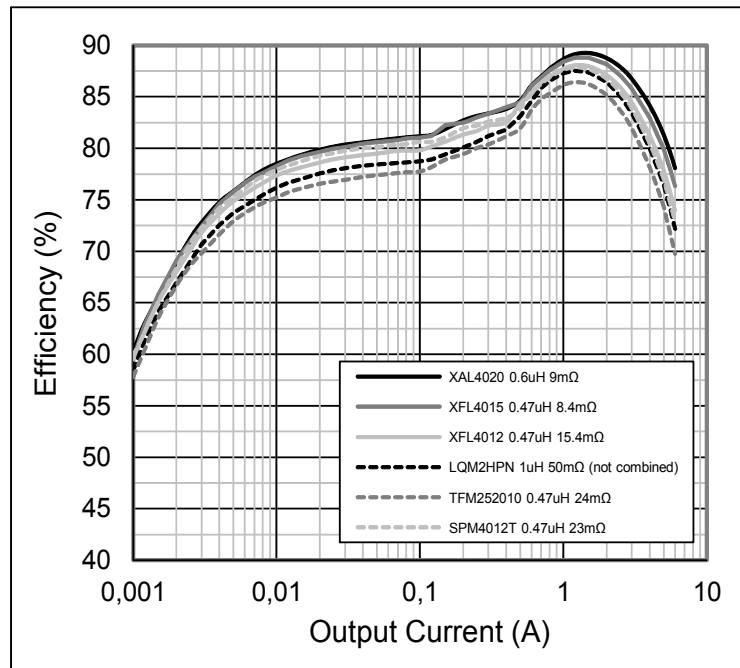

Figure 11:
5.0V Efficiency vs. Output Current Coil Comparison

AS3729 Step Down DCDC: Shows the Efficiency of the AS3729 for different coils @ 1.0V with VSUP=5.0V, 1.5MHz operation and $T_A=25^\circ\text{C}$.

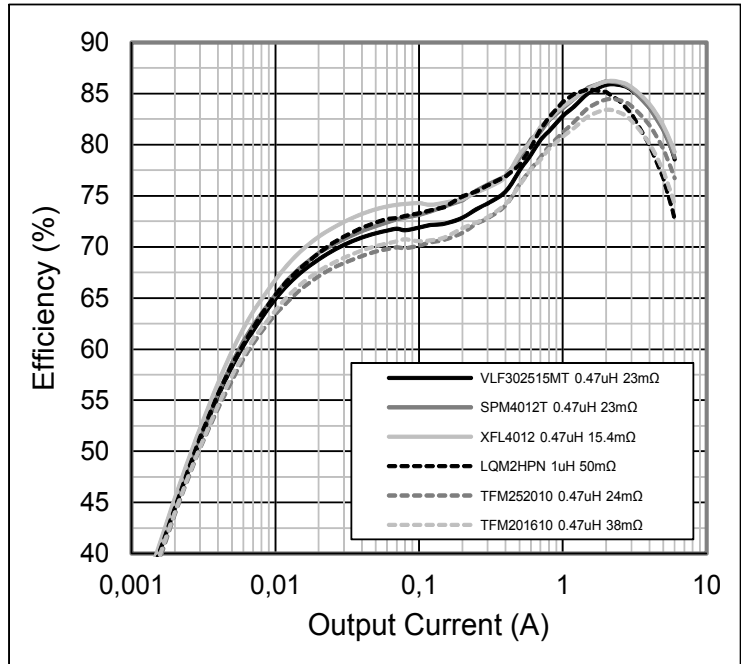

Figure 12:
5.0V Efficiency vs. Output Current Coil Comparison
Combined Mode

AS3729 Step Down DCDC: Shows the Efficiency of the AS3729 for different coils @ 1.0V with VSUP=5.0V, 1.5MHz operation and $T_A=25^\circ\text{C}$.

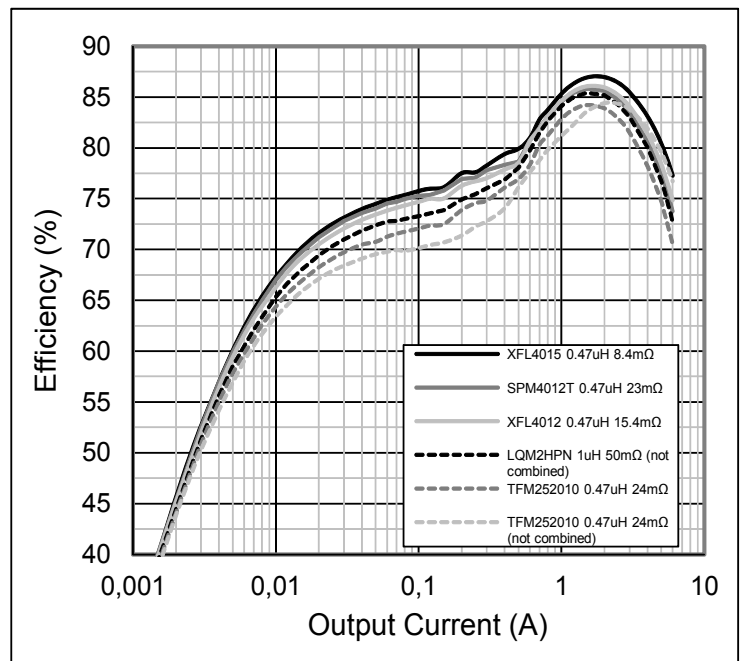

Figure 13:
3.7V Efficiency vs. Output Current XFL4012 Mode Comparison

AS3729 Step Down DCDC: Shows the Efficiency of the AS3729 in dual, combined and single phase mode @ 1.0V with VSUP=3.7V, 1.5MHz operation, TA=25°C and Coilcraft XFL4012-471MEB coil.

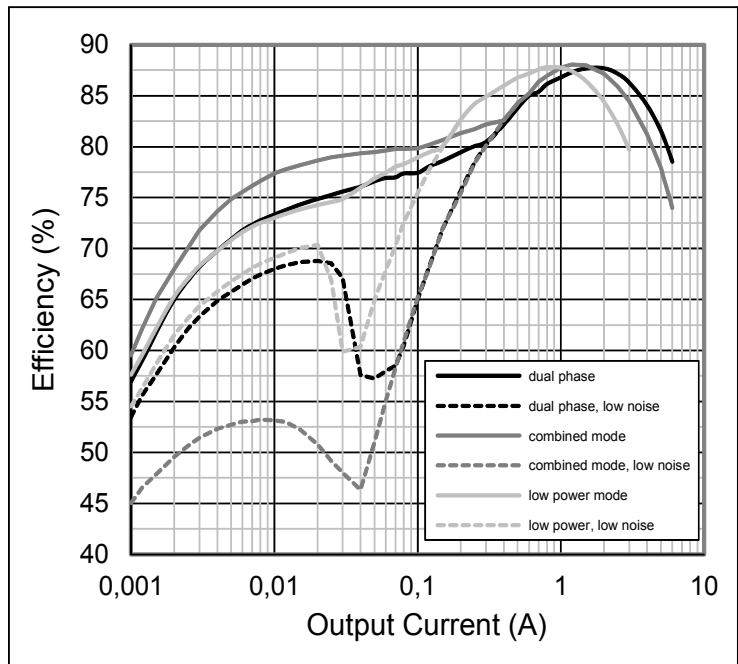

Figure 14:
3.7V Efficiency vs. Output Current SPM4012T Mode Comparison

AS3729 Step Down DCDC: Shows the Efficiency of the AS3729 in dual, combined and single phase mode @ 1.0V with VSUP=3.7V, 1.5MHz operation, TA=25°C and TDK SPM4012T-R47M coil.

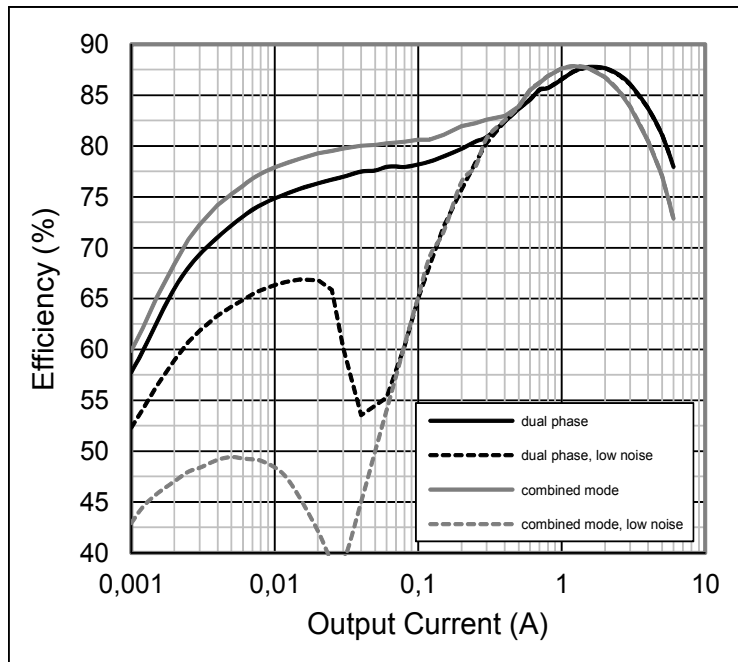

Figure 15:
3.7V Efficiency vs. Output Current TFM252010 Mode Comparison

AS3729 Step Down DCDC: Shows the Efficiency of the AS3729 in dual, combined and single phase mode @ 1.0V with $V_{SUP}=3.7V$, 1.5MHz operation, $T_A=25^\circ C$ and TDK TFM252010A-R47M coil.

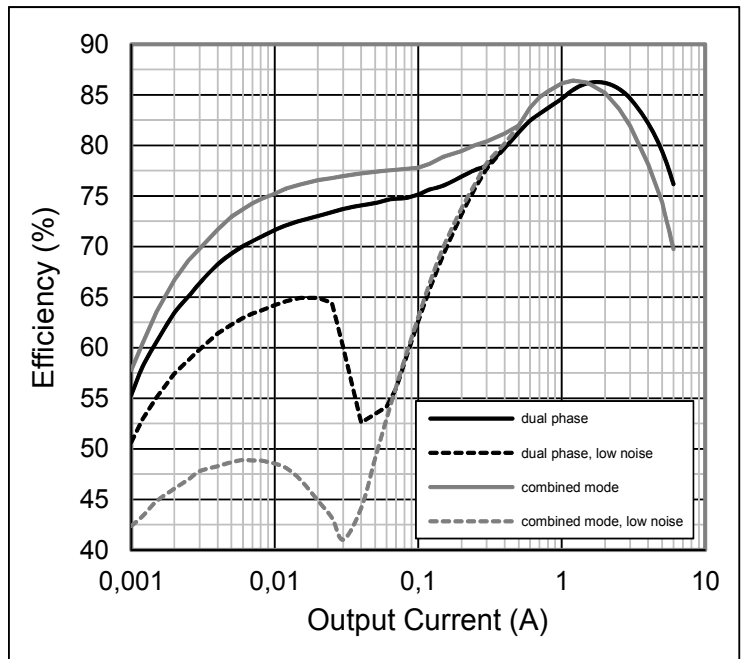

Figure 16:
3.7V Efficiency vs. Output Current XFL4012 Frequency Comparison

AS3729 Step Down DCDC: Shows the Efficiency of the AS3729 in dual phase mode @ 1.0V with $V_{SUP}=3.7V$, $T_A=25^\circ C$ and Coilcraft XFL4012-471MEB coil.

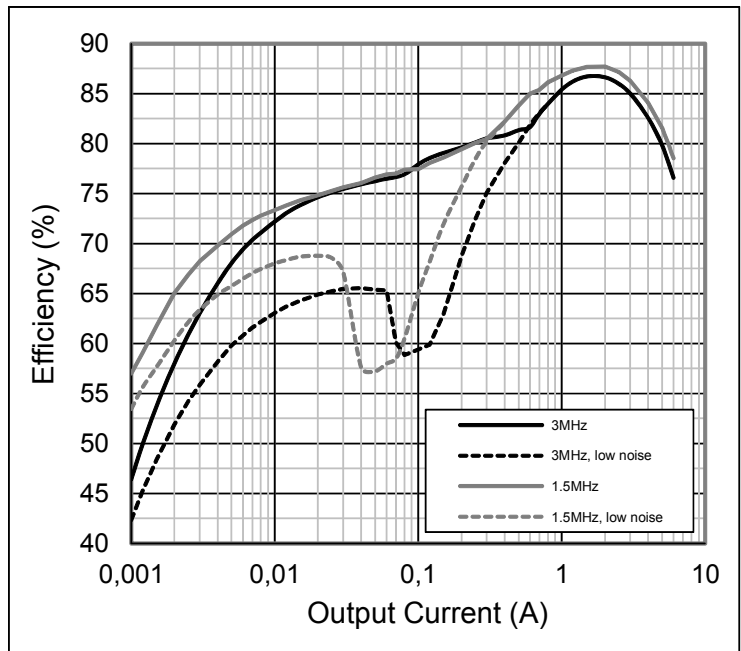
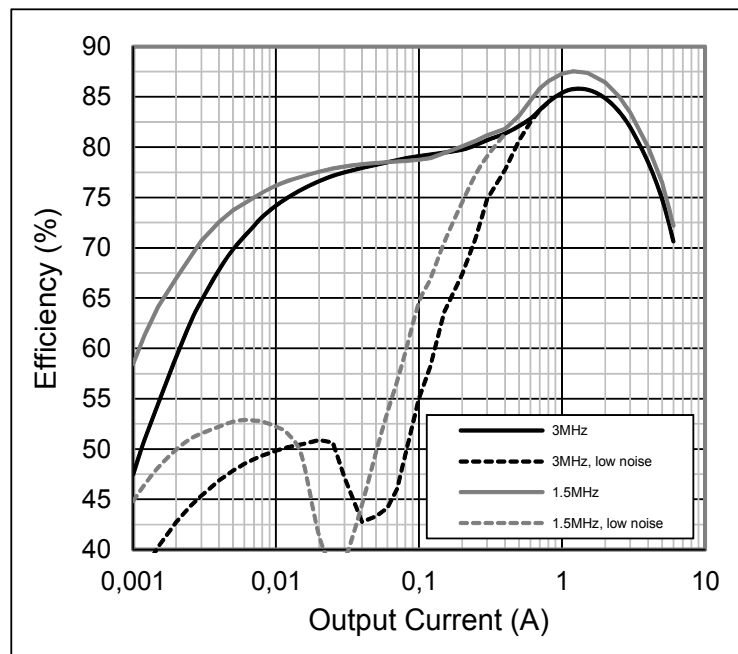

Figure 17:
3.7V Efficiency vs. Output Current LQMHPN Frequency Comparison

AS3729 Step Down DCDC: Shows the Efficiency of the AS3729 in dual phase mode @ 1.0V with $V_{SUP}=3.7V$, $T_A=25^\circ C$ and Murata LQM2HPN1R0MJH coil.



Application Information

Figure 18:
Typical Application Circuit

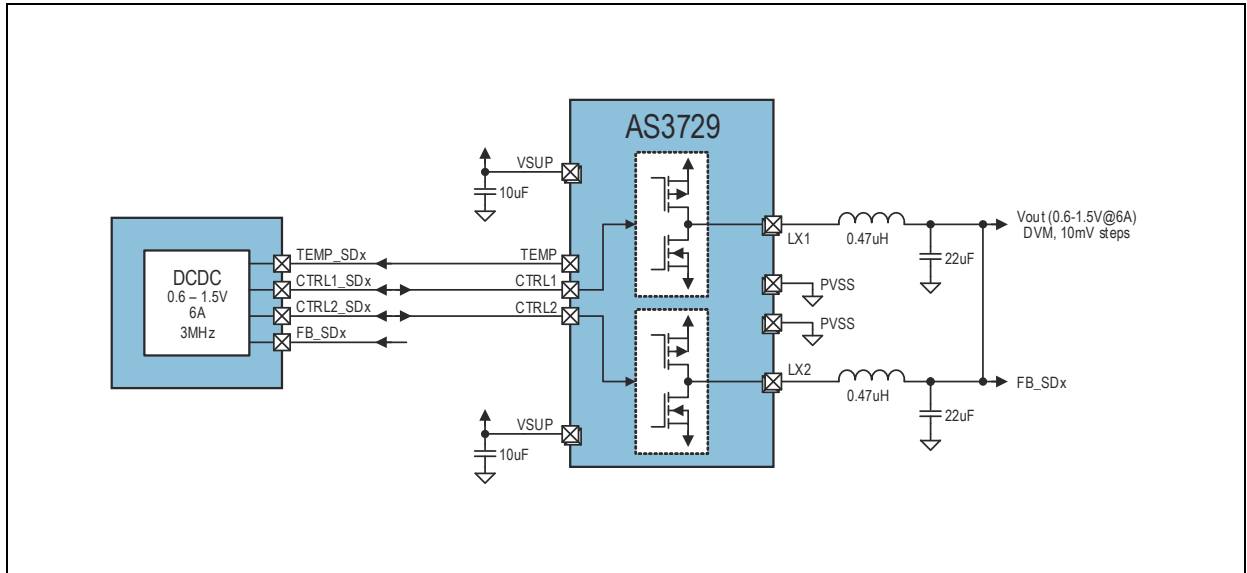

AS3729 Typical Application: This figure shows the connection of the DCDC controller and the AS3729 Power Stage.

Figure 19:
Layout Guidelines

Layout Guidelines: This figure shows the recommended layout and placement of the external components for the 2-phase AS3729 Power Stage

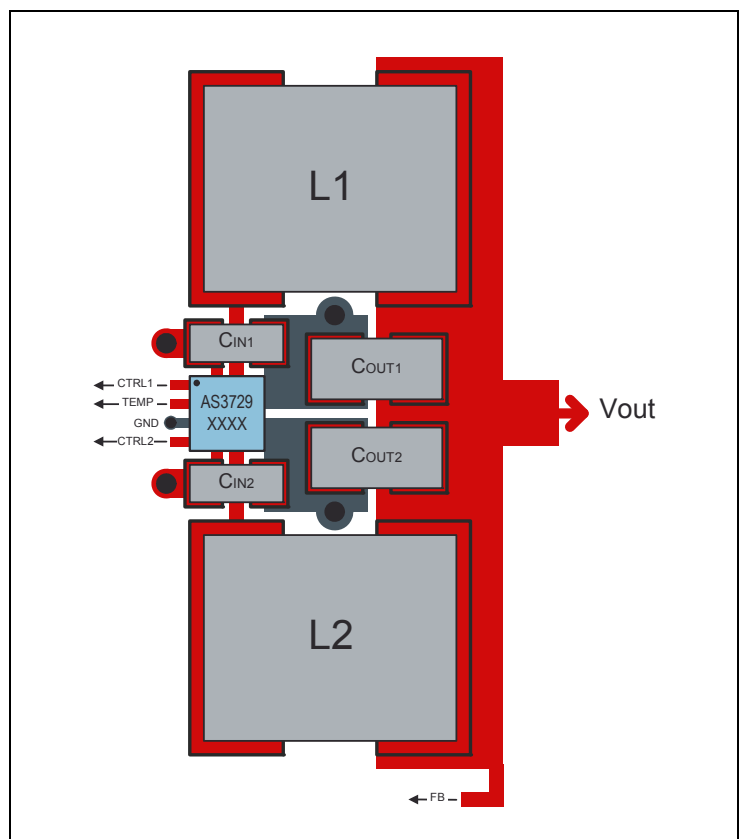

Package Drawings & Markings

Figure 20:
16-pin WL-CSP with 0.4mm Pitch

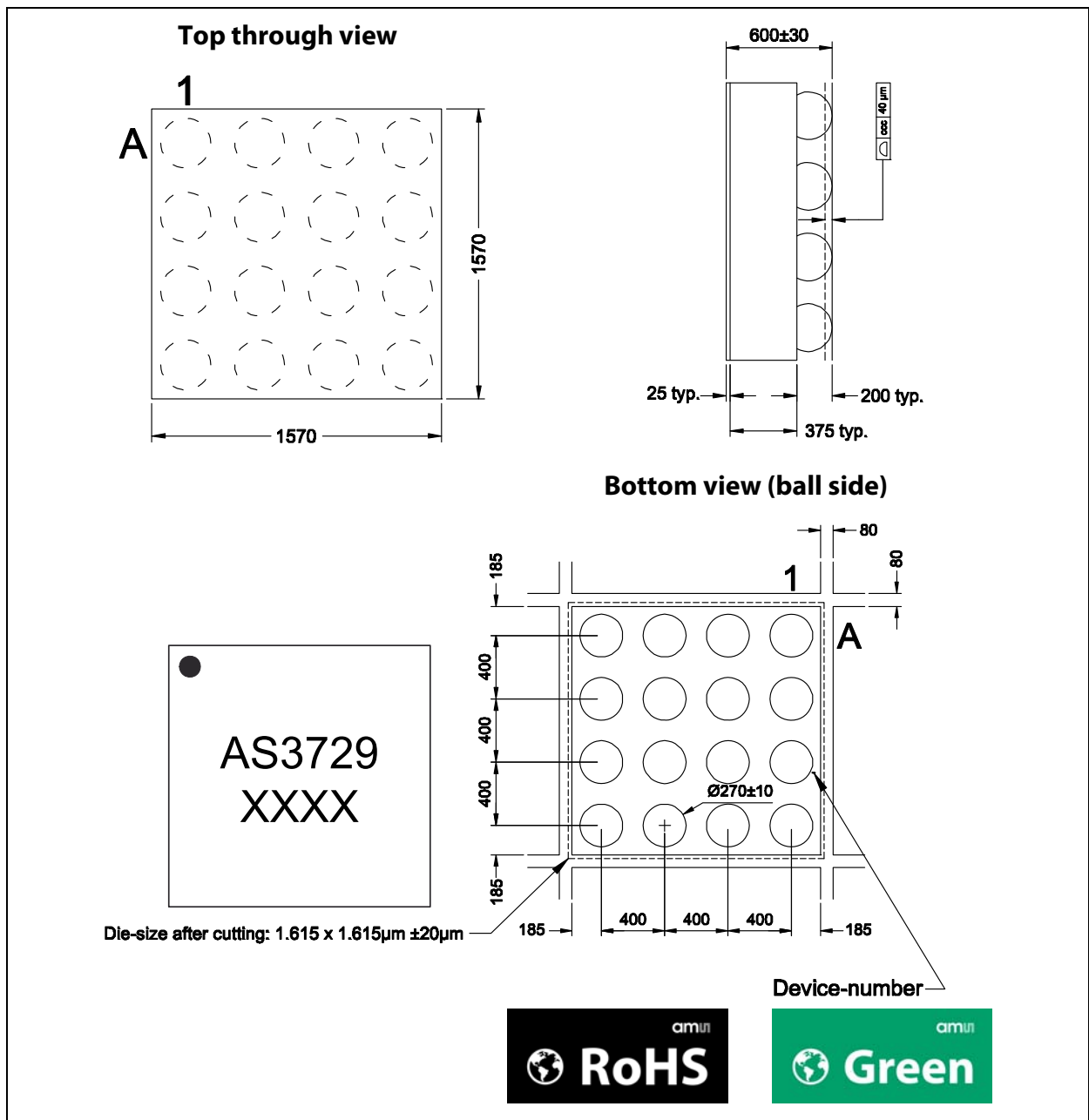

Note(s) and/or Footnote(s):

1. ccc Coplanarity.
2. All dimensions in μm.

Figure 21:
Package Code

XXXX
Tracecode

Ordering & Contact Information

Figure 22:
Ordering Information

Ordering Code	Description	Delivery Form	Package	Delivery Quantity
AS3729-BWLT	Power stage for multi-phase DCDC	Tape & Reel	16-pin WL-CSP	12000
AS3729-BWLM	Power stage for multi-phase DCDC	Tape & Reel	16-pin WL-CSP	500

Buy our products or get free samples online at:
www.ams.com/ICdirect

Technical Support is available at:
www.ams.com/Technical-Support

Provide feedback about this document at:
www.ams.com/Document-Feedback

For further information and requests, e-mail us at:
ams_sales@ams.com

For sales offices, distributors and representatives, please visit:
www.ams.com/contact

Headquarters

ams AG
Tobelbaderstrasse 30
8141 Unterpremstaetten
Austria, Europe

Tel: +43 (0) 3136 500 0

Website: www.ams.com

RoHS Compliant & ams Green Statement

RoHS: The term RoHS compliant means that ams AG products fully comply with current RoHS directives. Our semiconductor products do not contain any chemicals for all 6 substance categories, including the requirement that lead not exceed 0.1% by weight in homogeneous materials. Where designed to be soldered at high temperatures, RoHS compliant products are suitable for use in specified lead-free processes.

ams Green (RoHS compliant and no Sb/Br): ams Green defines that in addition to RoHS compliance, our products are free of Bromine (Br) and Antimony (Sb) based flame retardants (Br or Sb do not exceed 0.1% by weight in homogeneous material).

Important Information: The information provided in this statement represents ams AG knowledge and belief as of the date that it is provided. ams AG bases its knowledge and belief on information provided by third parties, and makes no representation or warranty as to the accuracy of such information. Efforts are underway to better integrate information from third parties. ams AG has taken and continues to take reasonable steps to provide representative and accurate information but may not have conducted destructive testing or chemical analysis on incoming materials and chemicals. ams AG and ams AG suppliers consider certain information to be proprietary, and thus CAS numbers and other limited information may not be available for release.

Copyrights & Disclaimer

Copyright ams AG, Tobelbader Strasse 30, 8141 Unterpremstaetten, Austria-Europe. Trademarks Registered. All rights reserved. The material herein may not be reproduced, adapted, merged, translated, stored, or used without the prior written consent of the copyright owner.

Devices sold by ams AG are covered by the warranty and patent indemnification provisions appearing in its General Terms of Trade. ams AG makes no warranty, express, statutory, implied, or by description regarding the information set forth herein. ams AG reserves the right to change specifications and prices at any time and without notice. Therefore, prior to designing this product into a system, it is necessary to check with ams AG for current information. This product is intended for use in commercial applications. Applications requiring extended temperature range, unusual environmental requirements, or high reliability applications, such as military, medical life-support or life-sustaining equipment are specifically not recommended without additional processing by ams AG for each application. This product is provided by ams AG "AS IS" and any express or implied warranties, including, but not limited to the implied warranties of merchantability and fitness for a particular purpose are disclaimed.

ams AG shall not be liable to recipient or any third party for any damages, including but not limited to personal injury, property damage, loss of profits, loss of use, interruption of business or indirect, special, incidental or consequential damages, of any kind, in connection with or arising out of the furnishing, performance or use of the technical data herein. No obligation or liability to recipient or any third party shall arise or flow out of ams AG rendering of technical or other services.

Document Status

Document Status	Product Status	Definition
Product Preview	Pre-Development	Information in this datasheet is based on product ideas in the planning phase of development. All specifications are design goals without any warranty and are subject to change without notice
Preliminary Datasheet	Pre-Production	Information in this datasheet is based on products in the design, validation or qualification phase of development. The performance and parameters shown in this document are preliminary without any warranty and are subject to change without notice
Datasheet	Production	Information in this datasheet is based on products in ramp-up to full production or full production which conform to specifications in accordance with the terms of ams AG standard warranty as given in the General Terms of Trade
Datasheet (discontinued)	Discontinued	Information in this datasheet is based on products which conform to specifications in accordance with the terms of ams AG standard warranty as given in the General Terms of Trade, but these products have been superseded and should not be used for new designs

Revision Information

Changes from 1-22 (2013-Aug) to current revision 1-24 (2015-Aug-13)	Page
1-22 (2013-Aug) to 1-23 (2015-Aug-11)	
Content was updated to the latest ams design	
Updated Figure 5	4
Updated Figure 6	5
Updated Figure 7	6
Updated titles of figures 8, 10, 12, 13 & 17	6 - 11
Updated Figure 18	12
Updated Figure 22	14
1-23 (2015-Aug-11) to 1-24 (2015-Aug-13)	
Updated Figure 21	13

Note(s) and/or Footnote(s):

1. Page and figure numbers for the previous version may differ from page and figure numbers in the current revision.
2. Correction of typographical errors is not explicitly mentioned.

Content Guide

1	General Description
1	Key Benefits & Features
1	Applications
2	Block Diagram
3	Pin Assignment
4	Absolute Maximum Ratings
5	Electrical Characteristics
6	Parameters
12	Application Information
13	Package Drawings & Markings
14	Ordering & Contact Information
15	RoHS Compliant & ams Green Statement
16	Copyrights & Disclaimer
17	Document Status
18	Revision Information